

YAMAHA

SERVICE MANUAL

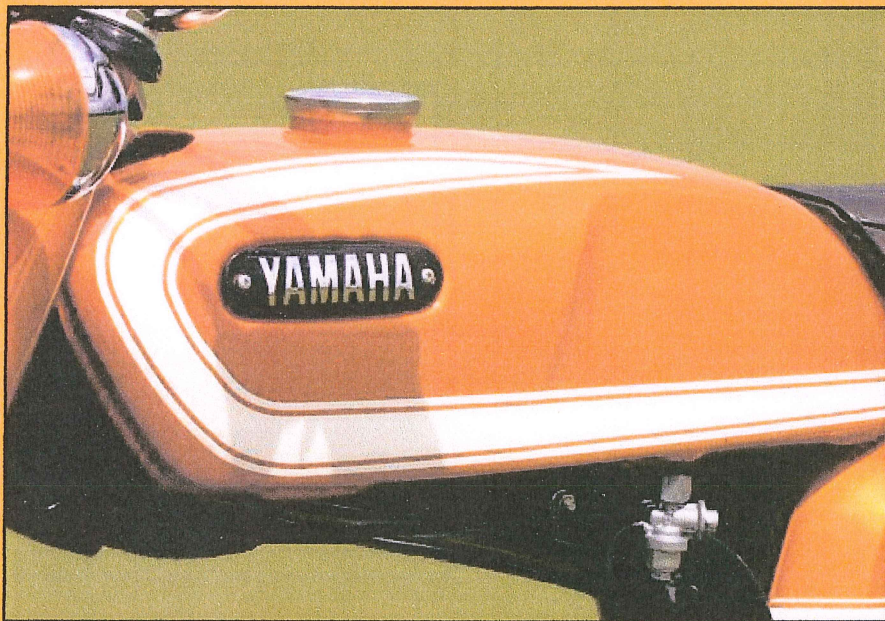

FS1 F5 J5 G5G



1969 - 1971

FOREWORD

This Service Manual to the Yamaha F5/J5, G5G and FS1 contains technical information as well as maintenance instructions required for servicemen charged with the task of keeping the machine in top condition.

We hope that the information included in this manual will help the rider enjoy many design features-Autolube, rotary valve, primary kick starter, and waterproof/dustproof brake drums – which assure long service life of the machine.

**YAMAHA MOTOR CO., LTD.
SERVICE DEPARTMENT**

CONTENTS

CHAPTER 1. GENERAL	1
1- 1 Features	1
1- 2 Specifications	2
1- 3 Tools and Instruments for Shop Service	4
CHAPTER 2. YAMAHA AUTOLUBE	6
2- 1 What is Yamaha Autolube?	6
2- 2 Features of Yamaha Autolube	6
2- 3 Handling the Oil Pump	6
CHAPTER 3. ENGINE	9
3- 1 Removing the Engine	9
3- 2 Cylinder Head	12
3- 3 Cylinder	13
3- 4 Piston Pin	14
3- 5 Piston Rings	15
3- 6 Piston	16
3- 7 Crankcase Cover (R)	17
3- 8 Clutch	19
3- 9 Primary Drive Gear	22
3-10 Kickstarter	23
3-11 Shifting Mechanism	26
3-12 Rotary Valve	27
3-13 Drive Sprocket	29
3-14 Splitting the Crankcase Halves	30
3-15 Transmission Assembly	32
3-16 Crankshaft	35
3-17 Bearings and Oil Seals	37
3-18 Carburetor	38
3-19 Air Cleaner	40
3-20 Transmission Oil	40

CHAPTER 4. CHASSIS	41
4- 1 Front Wheel	41
4- 2 Rear Wheel	43
4- 3 Front Fork	45
4- 4 Rear Cushion	49
4- 5 Steering Head	49
CHAPTER 5. ELECTRICAL EQUIPMENT	50
5- 1 Electrical Equipment	50
5- 2 List of Electrical Components	50
5- 3 Connection Diagram	51
5- 4 Ignition System-Function and Service	51
5- 5 Charging and Lighting System-Function and Checking	54
5- 6 Checking the Main Switch (Removed from the Chassis)	56
5- 7 Battery	57
5- 8 Spark Plug	57

CHAPTER 1. GENERAL

1-1 Features

1. **High Performance Rotary Valve Engine with Yamaha Autolube**
Yamaha's 2-stroke rotary valve engine with the YAMAHA Autolube system provides stable performance at low speed and smooth running at high speed as well as maximum acceleration at all speeds.
2. **Sturdy 7-bone Style Frame**
The new unique design of the frame provides greater strength required for both off and on the road riding.
3. **Easy Starting**
The engine can also be started by simply pulling in the clutch lever and kicking the starter without shifting the transmission gear back to neutral.
4. **Larger Lights**
Larger flasher and tail lights along with the easy-check speedometer insure additional safety for riders in heavy traffic.
5. **Easy Start Feature**
The starting feature within the carburetor assures easy starting in all types of weather.
6. **Powerful Brake**
Patented waterproof and dustproof brake drums provide safe, fade-free braking on wet or dusty roads.

GENERAL - Specifications

1-2 Specifications

Item		Models	F5	J5	G5G	FS1
Dimensions:						
Overall length			1,795mm (70.7")	1,795mm (70.7")	1,835mm (72.3")	1,755mm (69.1")
Overall width			720mm (28.3")	720mm (28.3")	720mm (28.3")	555mm (21.9")
Overall height			1,030mm (40.6")	1,030mm (40.6")	1,045mm (41.1")	935mm (36.8")
Wheelbase			1,165mm (45.9")	1,165mm (45.9")	1,165mm (45.9")	1,160mm (45.7")
Min. ground clearance			130mm (5.1")	130mm (5.1")	135mm (5.3")	135mm (5.3")
Weight	Net		71kg (157lbs)	71kg (157lbs)	79kg (174lbs)	70kg (154lbs)
Performance:						
Max. speed			More than 80km/h (50mph)	More than 83km/h (52mph)	90 ~ 94km/h (57 ~ 60mph)	95km/h (59mph)
Fuel consumption (on level, paved roads)			90km/ℓ (212mpg) at 30km/h (19mph)	85km/ℓ (200mpg) at 35km/h (22mph)	75km/ℓ (121mpg) at 35km/h (25mph)	80km/ℓ (188mpg) at 30km/h (19mph)
Climbing ability			18°	19°	20°	18°
Min. turning radius			1,800mm (70.9")	1,800mm (70.9")	1,800mm (70.9")	1,800mm (70.9")
Braking distance			6.5m(21.3ft)at35km/h (22mph)	6.5m(21.3ft)at35km/h (22mph)	6.5m(21.3ft)at35km/h (22mph)	7m(23ft)at35km/h (22mph)
Engine type:			2-stroke, gasoline, air-cooled.	Same as left	Same as left	Same as left
Lubricating system:			Separate lubrication (Yamaha Autolube)	Same as left	Same as left	Same as left
Cylinder arrangement:			Single, forward- inclined	Same as left	Same as left	Same as left
Displacement:			50cc (2.99cu.in.)	58cc (3.55cu.in.)	73cc (4.45cu.in.)	50cc (2.99cu.in.)
Bore and stroke:			40 x 39.7mm (1.575 x 1.563")	42 x 42mm (1.654 x 1.654")	47 x 42mm (1.850 x 1.654")	40 x 39.7mm (1.575 x 1.563")
Compression ratio:			7.1 : 1	6.8 : 1	6.8 : 1	6.9 : 1
Max. output:			4.8BHP/7,000r.p.m.	5.3BHP/7,000r.p.m.	6.7BHP/7,500r.p.m.	6.0BHP/9,000r.p.m.
Max. torque:			0.52 kg-m/ 6,000r.p.m. (3.75ft-lbs/ 6,000r.p.m.)	0.57 kg-m/ 6,000r.p.m. (4.12ft-lbs/ 6,000r.p.m.)	0.72 kg-m/ 6,000r.p.m. (5.2ft-lbs/ 6,000r.p.m.)	0.5 kg-m/ 8,000r.p.m. (3.6ft-lbs/ 8,000r.p.m.)
Starting method:			Kickstarter	Same as left	Same as left	Same as left
Ignition method:			Flywheel magneto	Same as left	Same as left	Same as left
Carburter:			VM16SC	VM16SC	VM16SC	VM16SC
Air cleaner:			Dry, paper filter	Same as left	Same as left	Same as left
Power Transmission:						
Clutch			Wet, multi-disc	Same as left	Same as left	Wet, multi-disc
Primary reduction method			Gear	Same as left	Same as left	Gear
Primary reduction ratio			3.894 (64/19)			3.894 (74/19)
Transmission			4-speed, constant mesh			5-speed, constant mesh

GENERAL - Specifications

Item	Models	F5	J5	G5G	FS1
Gear ratio: 1st		3.077 (40/13)	} Same as left	} Same as left	3.417 (41/12)
2nd		1.889 (34/18)			2.059 (35/17)
3rd		1.304 (30/23)			1.476 (31/21)
4th		1.038 (27/26)			1.167 (28/24)
5th					1.000 (26/26)
Secondary reduction method		Chain			Chain
Secondary reduction ratio		2.786 (39/14)	2.600 (39/15)	2.467 (37/15)	2.733 (41/15)
Chassis:					
Frame		Pressed steel back bone	} Same as left	} Same as left	} Same as left
Suspension (front)		Telescopic fork			
Suspension (rear)		Swinging arm			
Cushion (front)		Coil spring oil damper			
Cushion (rear)		Coil spring oil damper			
Steering:					
Steering angle		45° both sides	45° both sides	45° both sides	45° both sides
Caster		63°30'	63°30'	63°30'	63°30'
Trail		74.5mm (2.9")	74.5mm (2.9")	78mm (3.1")	75.6mm (3.0")
Brakes:					
Type		Internal expansion	} Same as left	} Same as left	} Same as left
Operation method (front)		Right hand-operated			
Operation method (rear)		Right foot-operated			
Tire (front):		2.25-17-4PR	2.25-17-4PR	2.50-17-4PR	2.25-17-4PR
Tire (rear):		2.25-17-4PR	2.25-17-4PR	2.50-17-4PR	2.25-17-4PR
Fuel tank capacity:		6 ℓ (1.6gal)	6 ℓ (1.6gal)	6.5 ℓ (1.7gal)	6 ℓ (1.6gal)
Fuel tank reserve:		1 ℓ (1.1qt)	Same as left	1.3ℓ (0.3 gal)	0.9ℓ (0.2 gal)
Oil tank capacity:		1.4 ℓ (1.5qt)	Same as left	1.4 ℓ (1.5qt)	1.4 ℓ (1.5qt)
Generator:					
Model		FAZ-1QL or F11-L40	} Same as left	FCH-1CL	FAZ-1QL
Manufacturer		Mitsubishi Electric or Hitachi		Mitsubishi Electric	Mitsubishi Electric
Spark plug:		B-7HS	B-7HS	B-7HS	B-8HCS
Battery:					
Model		6N4A-4D	} Same as left	} Same as left	} Same as left
Manufacturer					
Capacity		6V, 4AH			
Lights:					
Head light		6V, 15WD	} Same as left	} Same as left	} Same as left
Tail/stop light		6V, 3/10W			
Flasher light		6V, 8W			
Neutral light		6V, 3W			
Meter light		6V, 1.5W			

1-3 Tools and Instruments for Shop Service

The following tools and instruments are required to service the F5/J5, FS1 and G5G.

1. General Tools

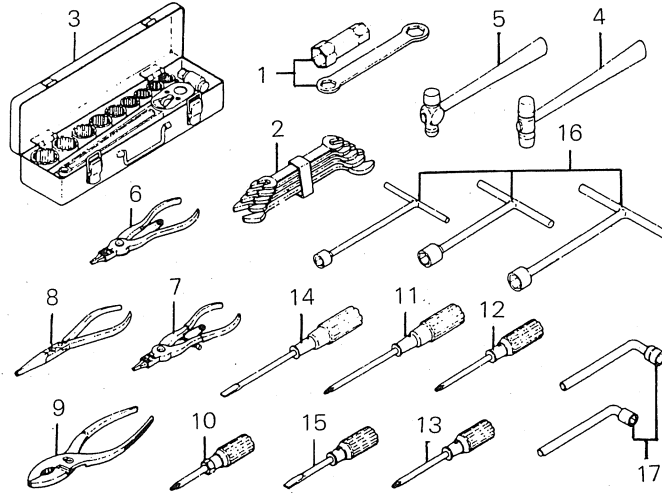

- | | |
|-----------------------------|-----------------------------------|
| 1. Plug wrench 23 x 29 mm | 10. Phillips-head screwdriver |
| 2. A set of wrenches | 11. Phillips-head screwdriver (L) |
| 3. A set of socket wrenches | 12. Phillips-head screwdriver (M) |
| 4. Plastic tip hammer | 13. Phillips-head screwdriver (S) |
| 5. Steel hammer | 14. Slot-head screwdriver |
| 6. Circlip pliers (ST type) | 15. Slot-head screwdriver (S) |
| 7. Circlip pliers (TR type) | 16. T-handle socket wrench |
| 8. Needle nose pliers | 17. L-handle socket wrench |
| 9. Pliers | |

Fig. 1-3-1

2. Special Tools and Instruments

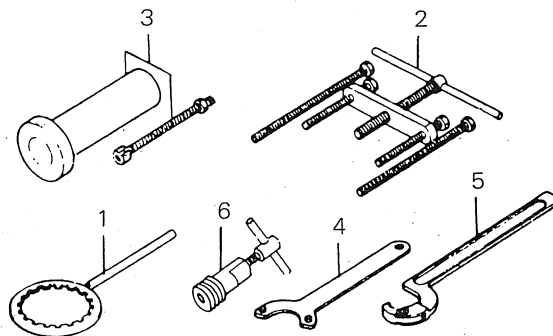

- | | |
|---------------------------------|-------------------------------------|
| 1. 100L1 clutch holding tool | 4. Flywheel magneto holding tool |
| 2. Crankcase disassembling tool | 5. New-type exhaust ring nut wrench |
| 3. Crankshaft assembling tool | 6. Flywheel magneto puller |

Fig. 1-3-2

In addition, an electro-tester, tachometer (engine rpm meter) hydrometer, etc. will be furnished.

3. Other Tools

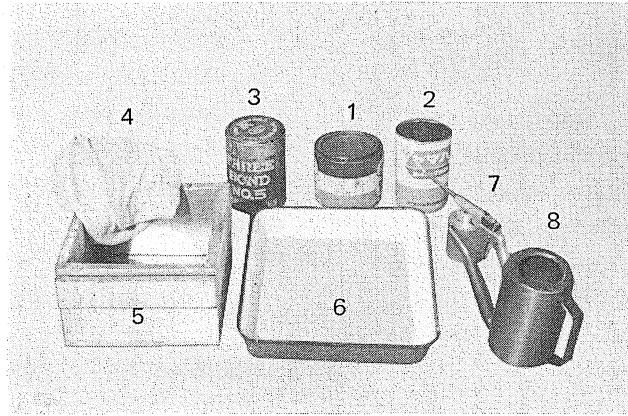

- | | |
|------------------------|----------------------|
| 1. Grease | 5. Overhauling stand |
| 2. Autolube oil | 6. Parts tray |
| 3. Yamaha Bond (No. 5) | 7. Oiler |
| 4. Wiping material | 8. Oil jug |

Fig. 1-3-3

The use of a wooden box as shown in the above photo will facilitate engine service and overhaul. Consumable parts (such as gaskets) and replacement parts must also be on hand.

CHAPTER 2. YAMAHA AUTOLUBE

2-1 What is Yamaha Autolube?

Conventional 2-stroke engines are lubricated by motor oil premixed in gasoline, but this premixing has been outdated by the Yamaha Autolube, which is an automatic lubrication device. It stores oil in the oil tank (separated from the fuel tank), and automatically meters oil to the engine by the oil pump.

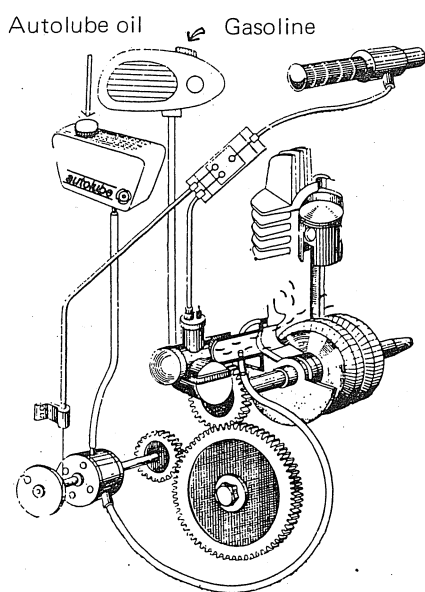

Fig. 2-1-1

2-2 Features of Yamaha Autolube

The oil pump is driven by the engine through a reduction gear, and connected to the throttle slide which is controlled by the accelerator grip.

The oil pump automatically regulates the volume of lubricating oil according to both engine speed and throttle opening, pumping a proper amount of oil to the engine under all operating conditions.

This "automatic separate lubrication" eliminates not only many disadvantages of the premixing system, but it furthers the potential efficiency, performance and durability of 2-stroke engines.

A) The Autolube feeds the precise amount of oil required to the engine under all operating conditions.

- Less oil consumption.
- Less carbon build-up.
- Less exhaust smoke.

- Improved lubrication efficiency.
- B) The Autolube simplified fuel supply.
- Gasoline supply only.
 - Clean engine.
- C) The Autolube provides highly dependable lubrication.
- No special care required for oil quantity and fuel-oil premixing ratios.

2-3 Handling the Oil Pump

The oil pump is a precision-machined assembly. Make no attempt to disassemble it. When you remove the oil pump from the engine, protect it from dust, dirt, etc. After reinstallation, be sure to bleed and set the pump and oil lines of air bubbles correctly. Proper handling will keep the pump free of trouble.

2-3-A. Checking and Adjusting the Minimum Pump Stroke

1. Checking
 - a. Fully close the accelerator grip. (In this case, pump stroke will be at minimum).
 - b. Turn the oil pump starter plate in the direction of the arrow marked on the plate. The adjusting plate is pushed up, thus causing a gap between the adjusting plate and the adjusting pulley. In this case, try to keep the gap at maximum. Measure it with your eyes.

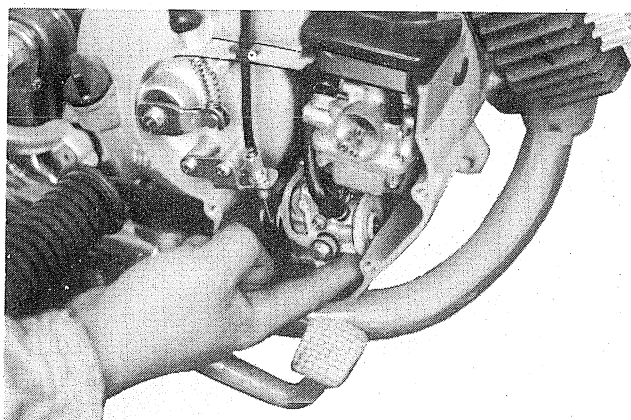

Fig. 2-3-1

- c. Insert a 0.15 mm feeler gauge into the gap. If the gap allows the gauge to enter, the pump stroke is normal. If not, the stroke is insufficient. (Adjustment is required).

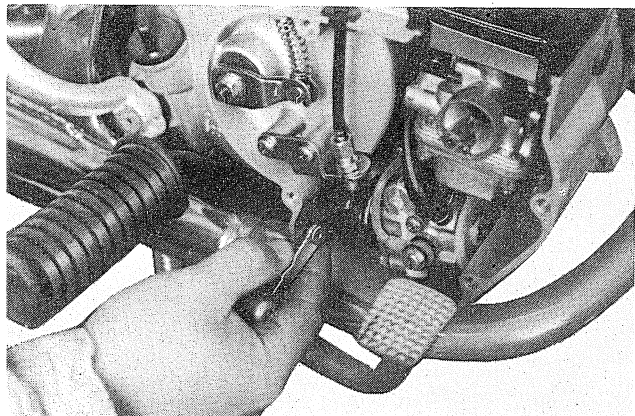

Fig. 2-3-2

2. Adjustment Methods

- a. Remove the adjusting plate, and insert a 0.1 mm adjusting shim.

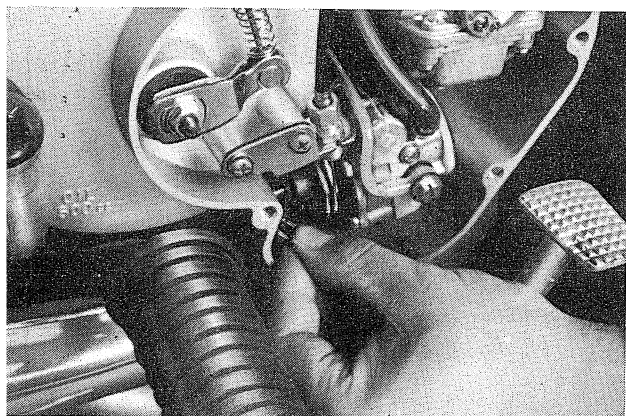

Fig. 2-3-3

- b. Reinstall the adjusting plate, and check the minimum stroke with the adjusting shim in place.

If the gap allows a 0.25 mm feeler gauge to enter, the adjustment is correct.

Minimum stroke

Adjusting limit . . . 0.15 mm or less

Correction standard. 0.20 ~ 0.25 mm

2-3-B. Checking and Adjusting the Setting of the Pump and Carburetor

After checking and adjusting the minimum stroke, set the carburetor and the pump in the following manner.

1. Checking

- a. Adjust the idle adjusting screw in the carburetor, and then adjust the free play of the throttle cable (B) to 1 ~ 2 mm (0.04" ~ 0.08").

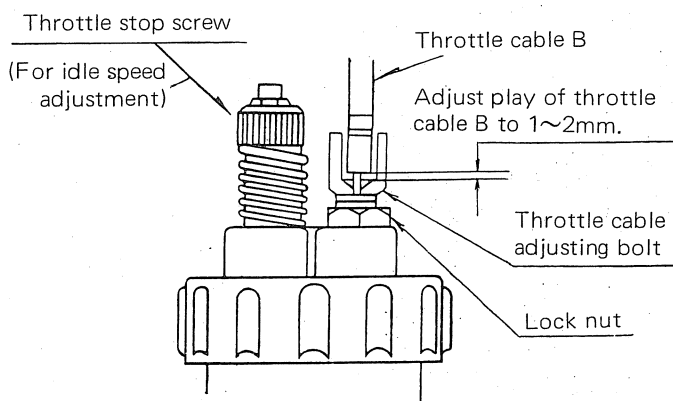

Fig. 2-3-4

- b. Slowly open the accelerator grip until the top of the stamped marking (circle) on the throttle valve comes in contact with the top of the main bore (in this case, the carburetor is at half throttle opening), and check to see if the pump guide pin is aligned with the marking on the adjusting pulley.

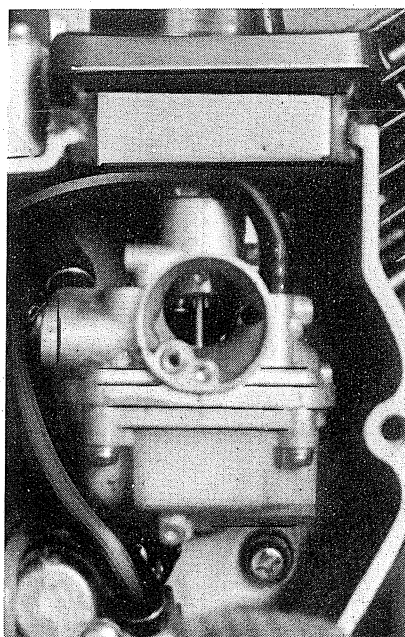

Fig. 2-3-5

2. Adjustment

- a. If the marking on the pump guide pin is not aligned with the marking on the adjusting pulley, loosen the lock nut shown in Fig. 2-3-6.

To align both markings, turn the adjusting screw in or out, and tighten or slacken the pump cable. After this adjustment, fully tighten the lock nut. After adjusting the play of the throttle cable, the pump cable also should be adjusted, if required.

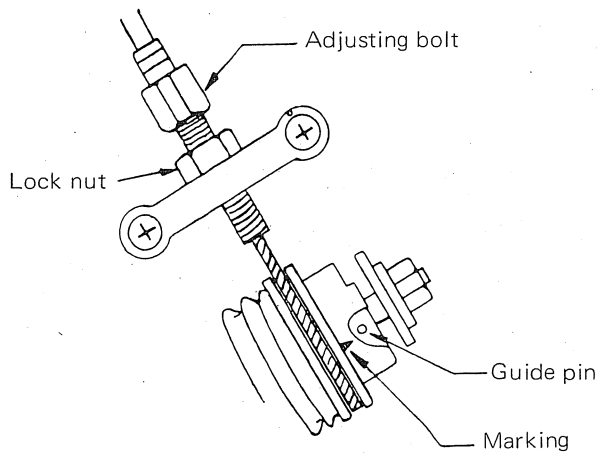

Fig. 2-3-6

2-3-C. Bleeding

When the oil pump is removed or when the Autolube oil tank is emptied, air enters the pump case, causing an irregular flow of oil. This is due to air bubbles in the delivery pipe. The pump must be bled.

- 1) Remove the bleeder bolt.

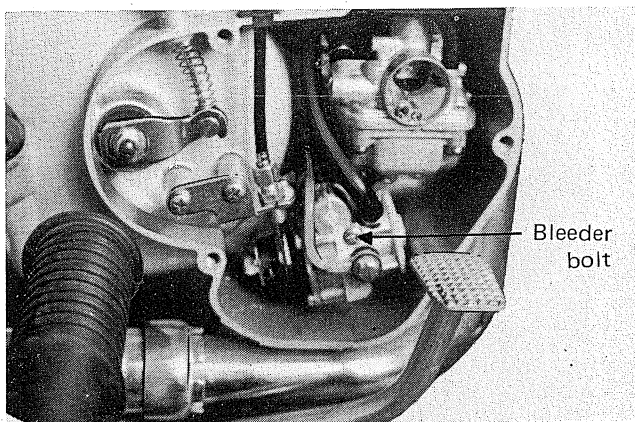

Fig. 2-3-7

- 2) Next turn the starter plate in the direction of the arrow (to the right facing the pump body) to force out all of the air. Then tighten the bleeder bolt. For this bleeding fully open the accelerator grip and rotate the starter plate, so that pump stroke will become greater and air may be expelled more quickly.

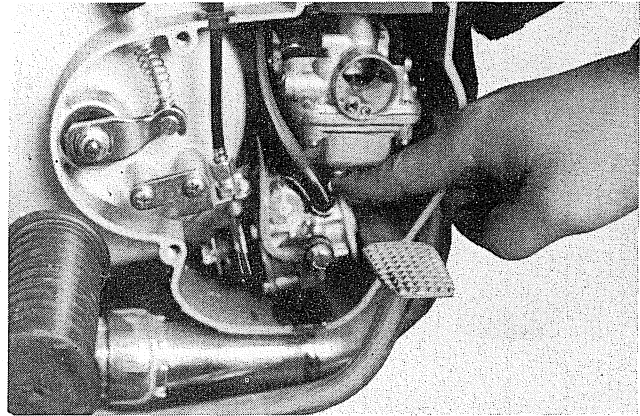

Fig. 2-3-8

CHAPTER 3. ENGINE

The engine should be disassembled in an orderly sequence for easy and efficient work.

- Caution on Engine Disassembly
1. Before removing the engine from the chassis, clean dirt and dust from the cylinder head, cylinder and crankcase, and keep these components clean during disassembly.
 2. Always use clean tools, and use them correctly to avoid damaging parts.
 3. Keep the disassembled parts on the parts trays separately in each group.

3-1 Removing the Engine

1. Drain the transmission oil after running the engine for 1 to 2 minutes. (Fig. 3-1-1)

Note:

The transmission oil can be quickly drained after 1 to 2 minutes of engine warming up.
Oil amount: 600 ~ 650 cc (0.64 ~ 0.68 qt.)
(SAE 10/30W)

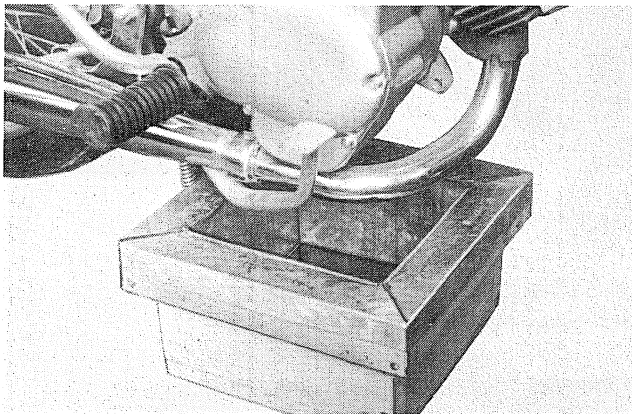

Fig. 3-1-1

2. Remove the exhaust pipe. (Fig. 3-1-2 and 3)

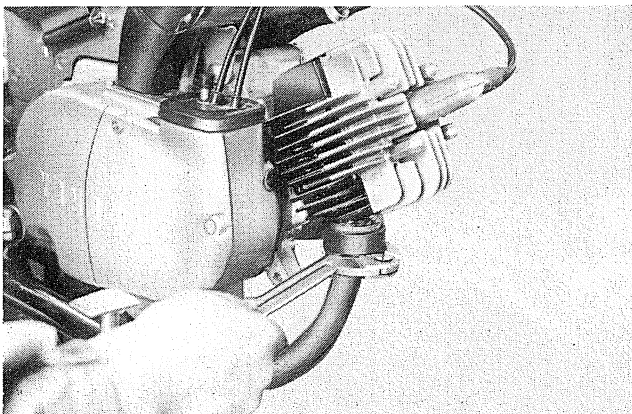

Fig. 3-1-2

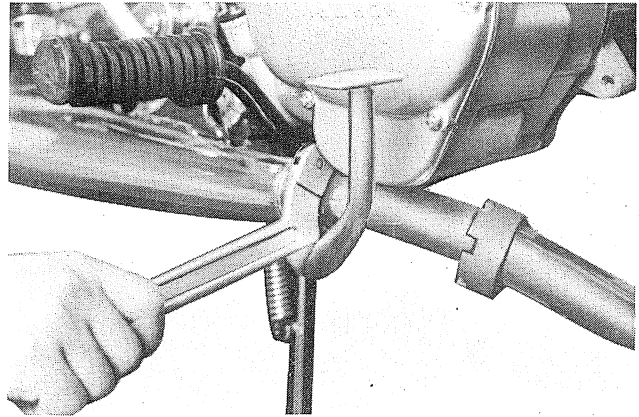

Fig. 3-1-3

3. Remove the change pedal. (Fig. 3-1-4)

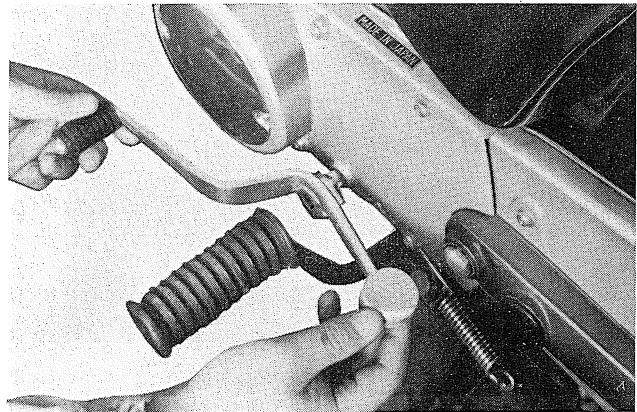

Fig. 3-1-4

4. Remove the crankcase cover (L). (Fig. 3-1-5)

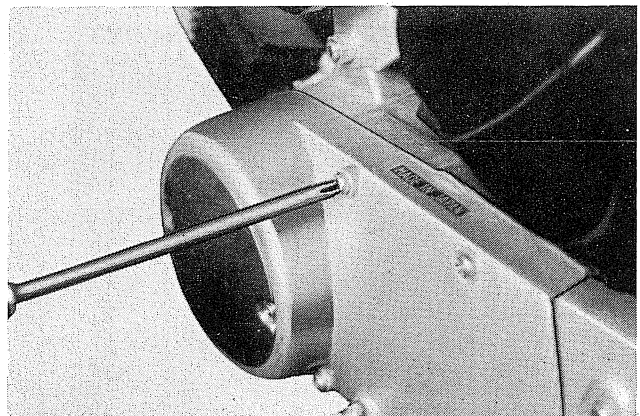

Fig. 3-1-5

ENGINE - Removing the Engine

5. Remove the flywheel magneto. (Fig. 3-1-6 and 7)

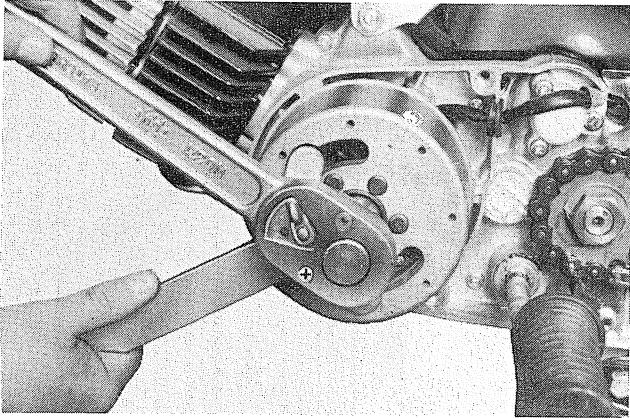

Fig. 3-1-6

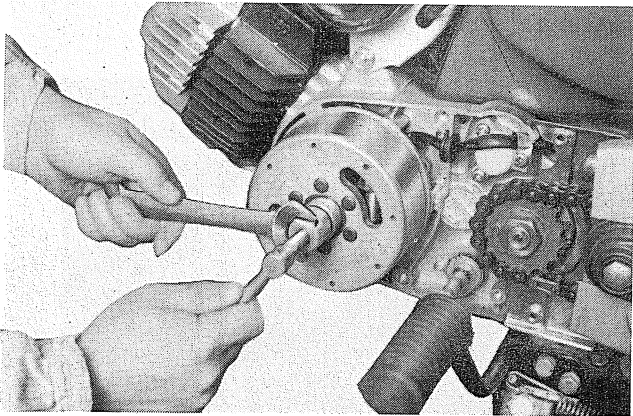

Fig. 3-1-7

6. Remove the flywheel magneto base, and hold it to the frame with a string, so that engine removal can be facilitated. (Fig. 3-1-8 and 9)

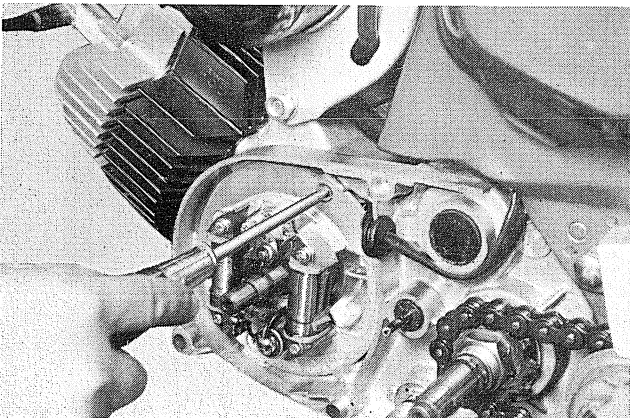

Fig. 3-1-8

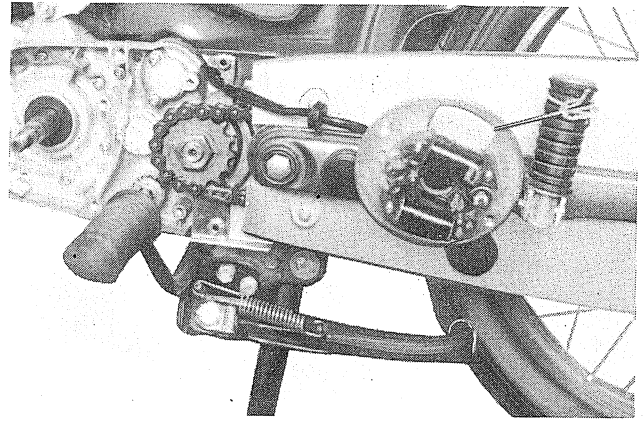

Fig. 3-1-9

7. Pry out the woodruff key (segment key) with a slot-head screwdriver. (Fig. 3-1-10)

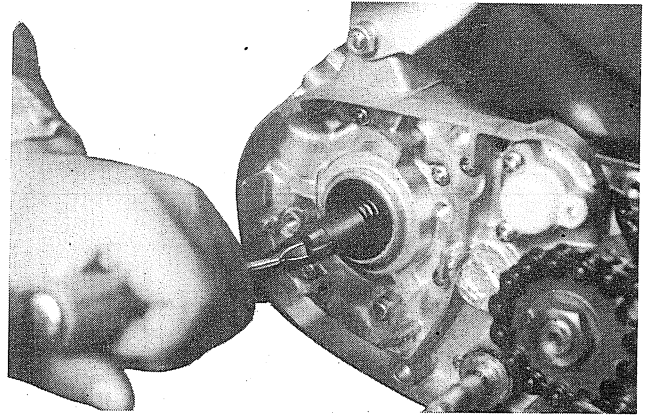

Fig. 3-1-10

8. Disconnect the chain case (lower), and remove the chain from the joint. (Fig. 3-1-11)

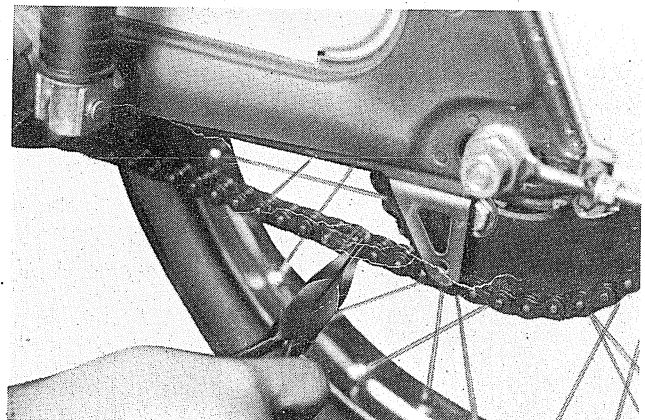

Fig. 3-1-11

9. Remove the carburetor cover. (Fig. 3-1-12)

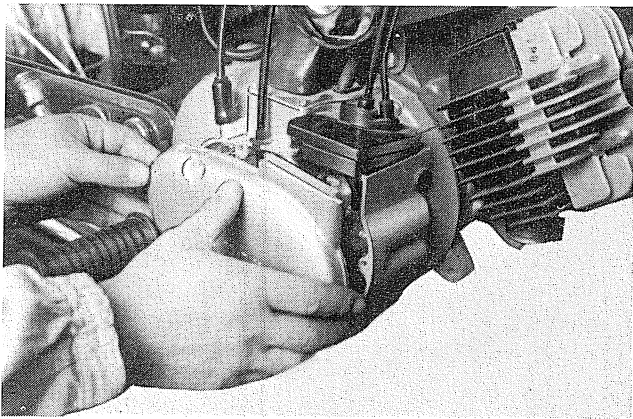

Fig. 3-1-12

10. Turn the fuel cock to the STOP position, and remove the carburetor. (Fig. 3-1-13)

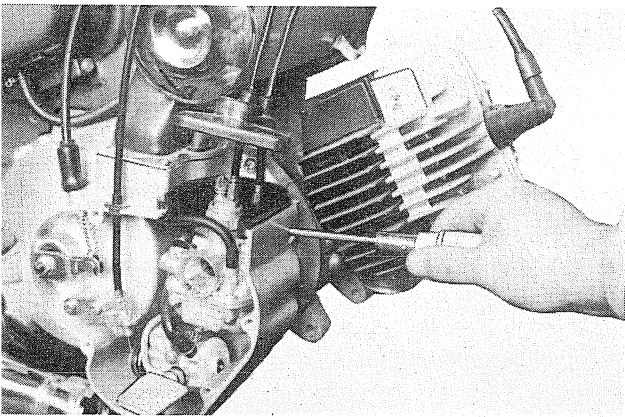

Fig. 3-1-13

1. Disconnect the oil pipe. (Plug the line to prevent oil from flowing out of the pipe.) (Fig. 3-1-14)

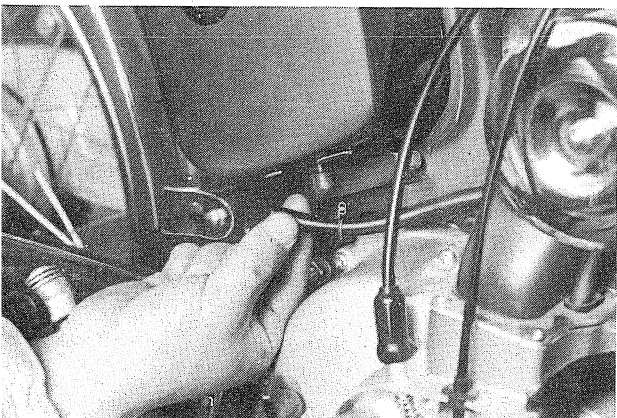

Fig. 3-1-14

12. Disconnect the pump cable, together with the adjusting holder. (Fig. 3-1-15)

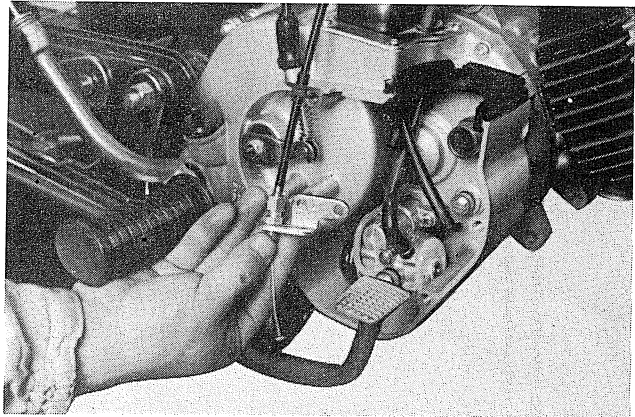

Fig. 3-1-15

13. Disconnect the clutch cable. (Fig. 3-1-16)
(For reinstallation, refer to 3-8 Clutch Adjustment.)

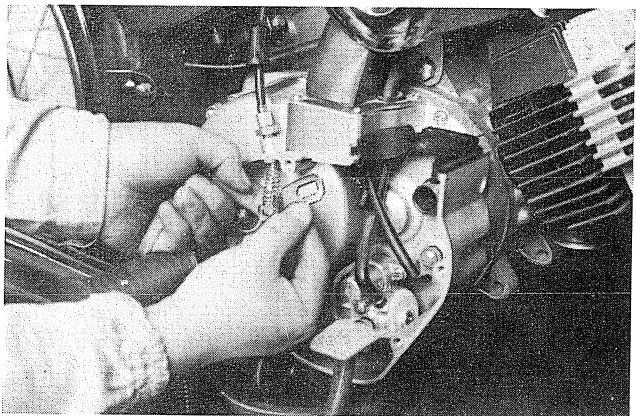

Fig. 3-1-16

14. Remove the air cleaner. (Fig. 3-1-17)

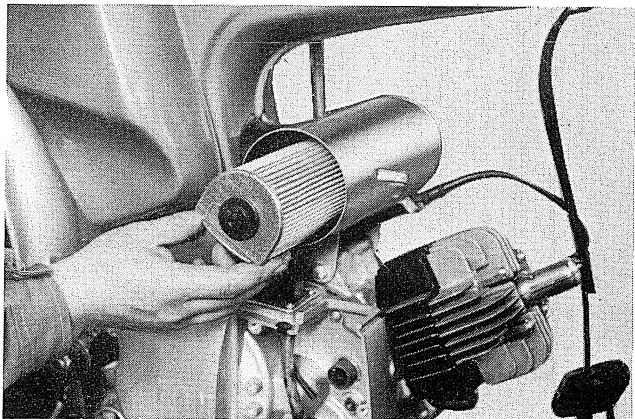

Fig. 3-1-17

ENGINE - Cylinder Head

15. Pull out the two mounting bolts on the upper part of the engine, and loosen the foot rest mounting bolt. Then tilt the engine forward. (Figs 3-1-18 and 19)

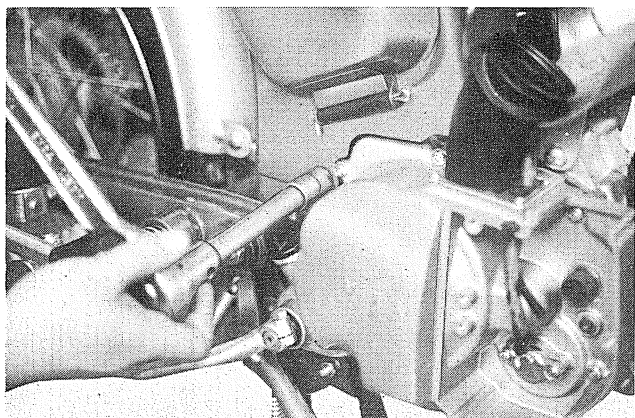

Fig. 3-1-18

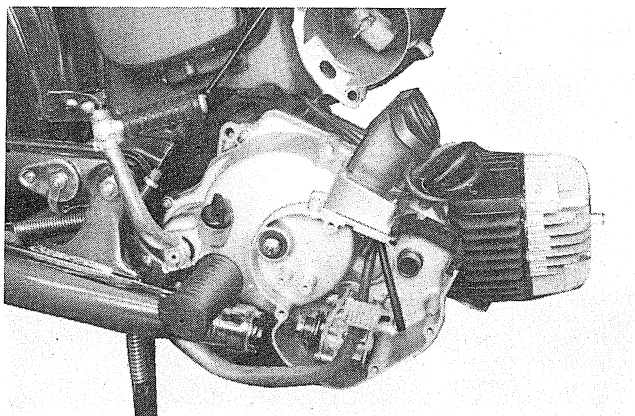

Fig. 3-1-19

16. Disconnect the cable from the neutral light switch. (Fig. 3-1-20)

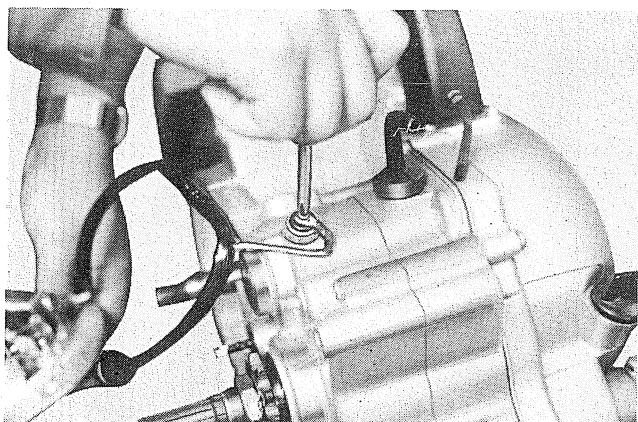

Fig. 3-1-20

17. Pull out the foot rest mounting bolt, and remove the engine from the chassis. (Fig. 3-1-21)

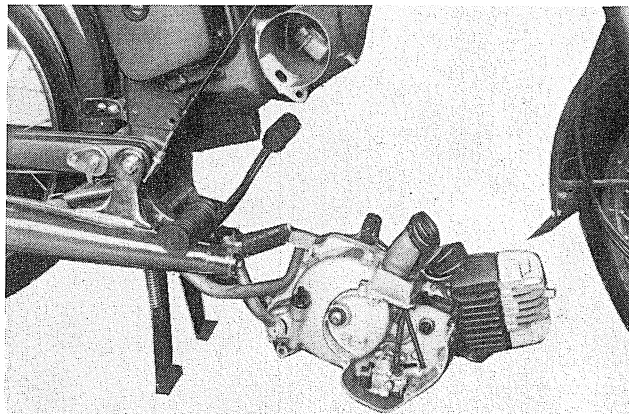

Fig. 3-1-21

3-2 Cylinder Head

A. Removal and Reinstallation

Remove the spark plug. Remove the four nuts from the top of the cylinder head, and remove the cylinder head gasket. For reinstallation, reverse the above sequence. Replace any deformed gasket. (Fig. 3-2-1)

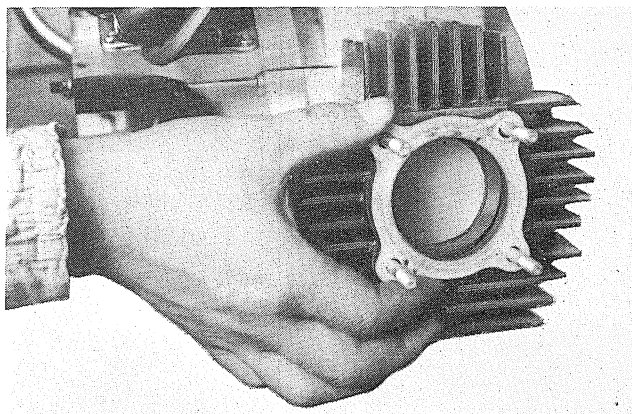

Fig. 3-2-1

B. Removing Carbon

Carbon build-up in the combustion chamber of the cylinder head increases the compression ratio, causing pre-ignition, overheating, and greater fuel consumption. Clean the cylinder head. (Fig. 3-2-2)

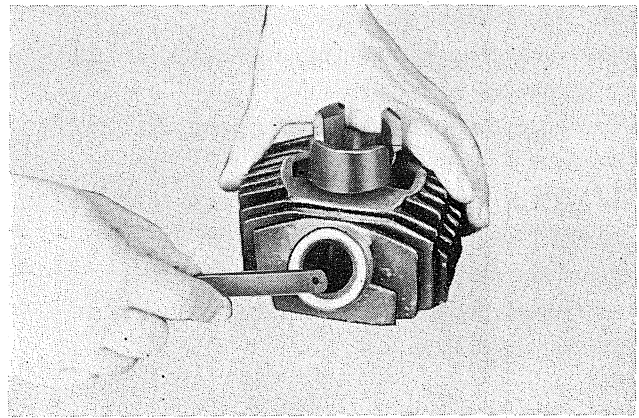

Fig. 3-2-2

3-3 Cylinder

A. Checking Cylinder Wear

Measure the cylinder bore diameter at four different depths with a bore measuring micrometer or a cylinder gauge placed parallel with, then at right angles to the crankshaft, for 8

measurements in each cylinder. If the difference between the maximum and minimum diameters measured exceeds 0.05 mm, rebore and hone the cylinder. (Figs. 3-3-1 and 2)

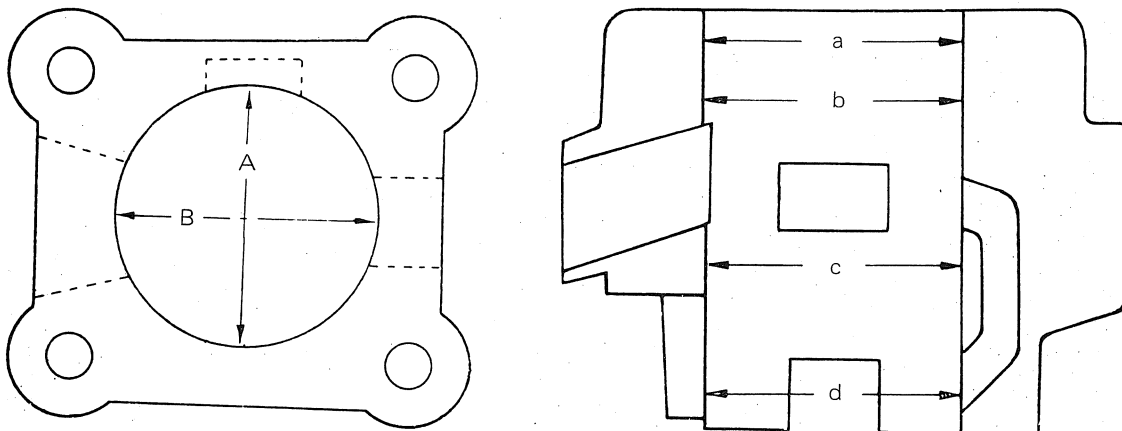

Figs. 3-3-1 Measuring Positions of the Bore

B. Minimum Clearance between Piston and Cylinder

The minimum clearance between the piston and the cylinder should be below (Fig. 3-3-2)

Unit: mm

	F5/J5	G5G	FS1
Export-except specific area	0.035 ~ 0.040	0.030 ~ 0.035	0.035 ~ 0.040
Southeast Asia	0.030 ~ 0.035	0.030 ~ 0.035	0.030 ~ 0.035
Middle & Near East	0.040 ~ 0.045	0.040 ~ 0.045	0.040 ~ 0.045
High Lands	0.025 ~ 0.030	0.025 ~ 0.030	0.030 ~ 0.035

Fig. 3-3-2

ENGINE - Piston Pin

Cylinder Reconditioning

The cylinder should be reconditioned in the following manner.

- a. Piston are available in 0.25 mm and 0.50 mm oversizes.
- b. Cylinder should be rebored and honed to the diameter of the oversize piston.
- c. The error between the maximum and minimum bore diameters after honing should be no more than 0.01 mm.

C. Installing Cylinders

- 1) Always use new cylinder gaskets when overhauling the engine. (Fig. 3-3-3)

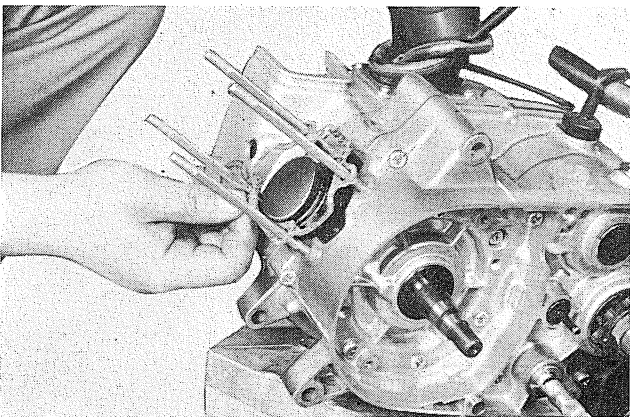

Fig. 3-3-3

- 2) When installing the cylinder over the piston, squeeze the piston rings into their grooves (The ring ends should be positioned close on the respective locating pins), so that they will not catch and break on the bottom of the cylinder. (Careless handling may break rings.) (Fig. 3-3-4)

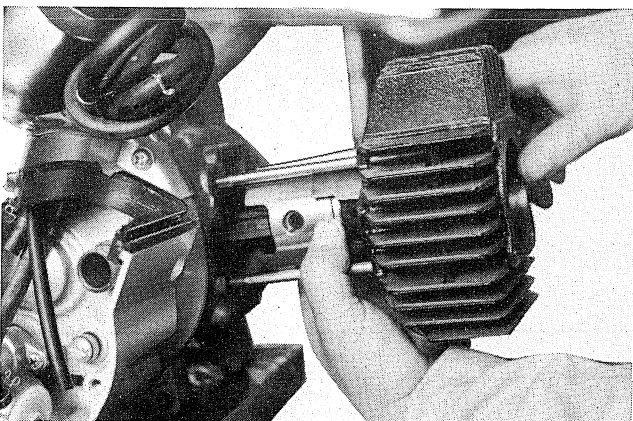

Fig. 3-3-4

D. Removing Carbon

Carbon tends to accumulate heavily on the wall of the cylinder exhaust port. Scrape the carbon off with a screwdriver. (Fig. 3-3-5)

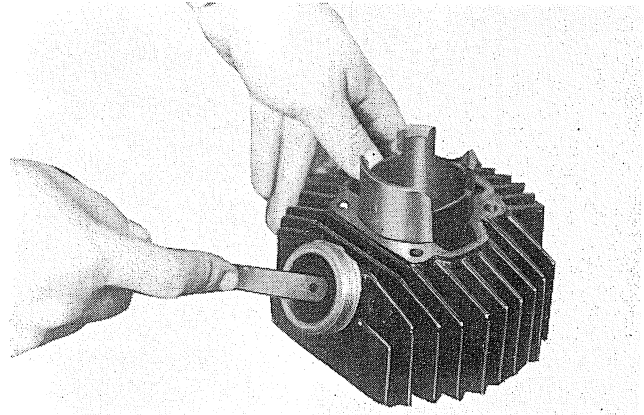

Fig. 3-3-5

3-4 Piston Pin

A. Driving Out the Piston Pin

Remove the clip at each end of the piston pin, with needle nose pliers, and push the pin out from the piston with a finger or a screwdriver. (Fig. 3-4-1)

Before removing the piston pin clips, cover the crankcase with a clean rag to prevent the clips from entering the crankcase.

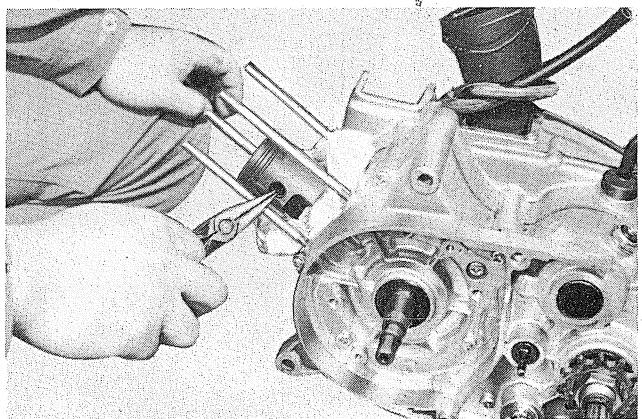

Fig. 3-4-1

B. Piston-to-Piston Pin Fit

The piston pin should fit snugly in its bore so that it drags a little when it is pushed with a finger. If the pin is loose, the pin and/or the piston should be replaced. A pin with step-wear should also be replaced. (In this case, the needle bearing also should be replaced).

3-5 Piston Rings

A. Removing Rings

Put both thumbs at each end of the piston ring and pull the piston ring ends apart, and slide it out of the groove on the other side of the ring ends. (Figs. 3-5-1 and 2)

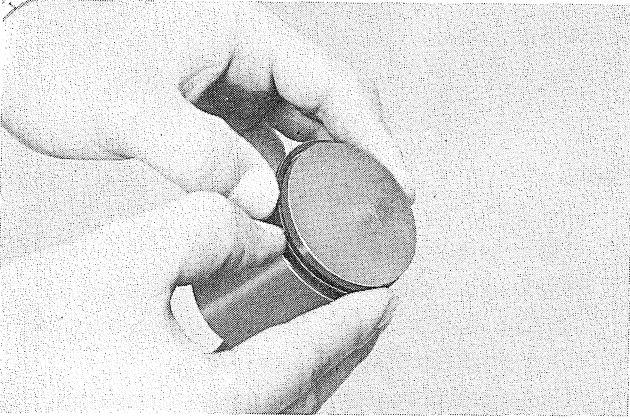

Fig. 3-5-1



Fig. 3-5-2

B. Fitting the Rings

First fit the No. 2 ring (parkerized) over the piston, and then the No. 1 ring (chrome) and align their end gaps with the locating pin in each ring groove. (Fig. 3-5-3)

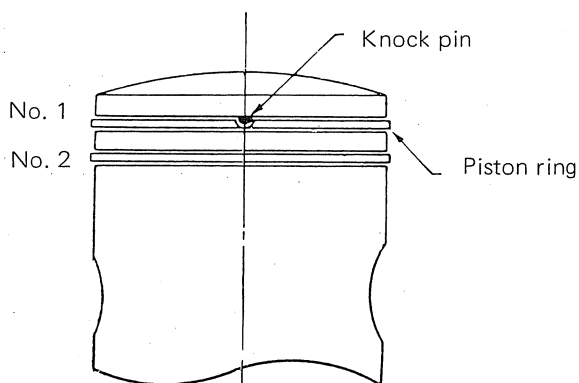

Fig. 3-5-3

C. Checking Piston Rings

1) Measuring Piston Ring Wear

Put each ring into the cylinder so that the ring is parallel with the cylinder bottom, and measure the end gap with a feeler gauge. (Fig. 3-5-4)

Each gap should be between 0.15 and 0.35 mm for both No. 1 and No. 2 rings.

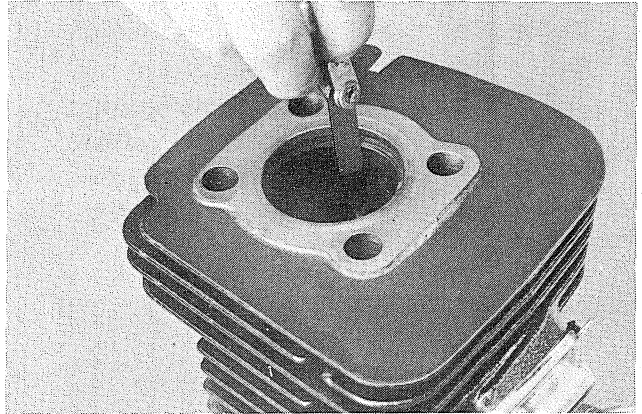

Fig. 3-5-4

2) Removing Carbon

Carbon on the piston rings and in the ring grooves will make the rings stick to the piston. Remove the ring from the piston, and clean the carbon from the rings and grooves.

3-6 Piston

A. Checking and Reconditioning the Piston

1) Measuring Piston Clearance

Piston clearance mentioned here is defined as the difference between the minimum cylinder bore diameter and the maximum outside diameter of the piston. As described in 3-3 Cylinder, piston clearance should be as shown Fig. 3-3-2. To determine the maximum piston outside diameter, measure it with a micrometer at right angles to the skirt and 10 mm above the bottom edge. (Fig. 3-6-1)

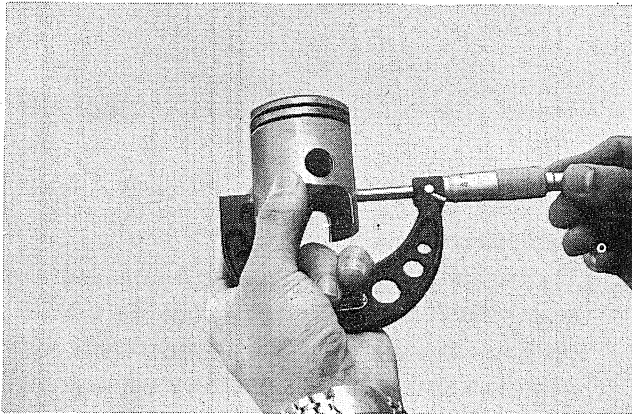

Fig. 3-6-1

2) Checking and Correcting Scratches

Pistons showing signs of seizure are noisy and keep the engine from developing full power. If a piston that has seized up is used again without correction, another seizure will develop at the same point, causing damage to the cylinder. Lightly sand these seizure "high spots" on the piston with #400 sandpaper. (Figs. 3-6-2 and 3)

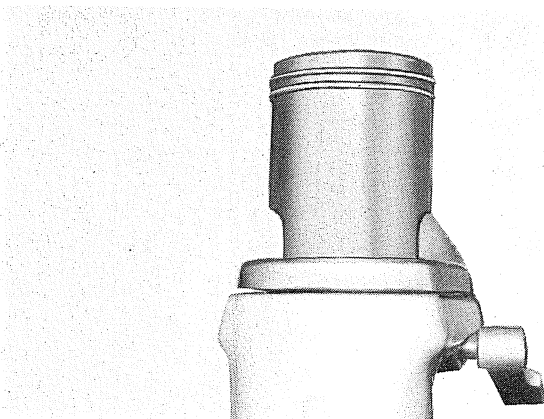

Fig. 3-6-2

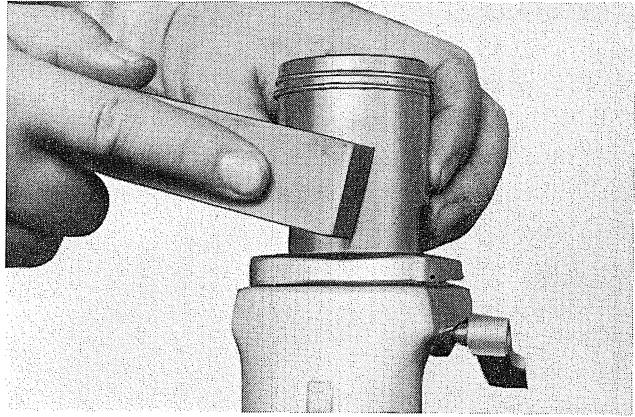

Fig. 3-6-3

3) Removing Carbon

Carbon accumulations on the piston head should be carefully removed with a knife or a other scraper. (Fig. 3-6-4)

Carbon accumulations on the piston ring groove make the ring stick to the piston. Remove the carbon. (Fig. 3-6-5)

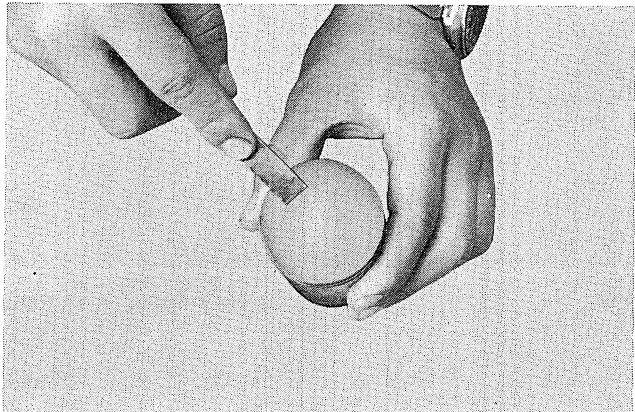

Fig. 3-6-4



Fig. 3-6-5

B. Installing the Piston in its Proper Direction

Install piston with the arrow marked on the piston head pointing downward (toward the exhaust port). (Fig. 3-6-6)

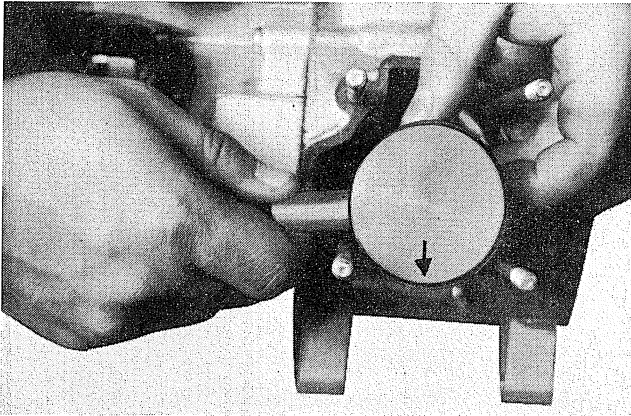

Fig. 3-6-6

3-7 Crankcase Cover (R)

A. Removal

- 1) Remove the kick starter crank clamping bolt, and remove the kick starter crank. (Fig. 3-7-1)

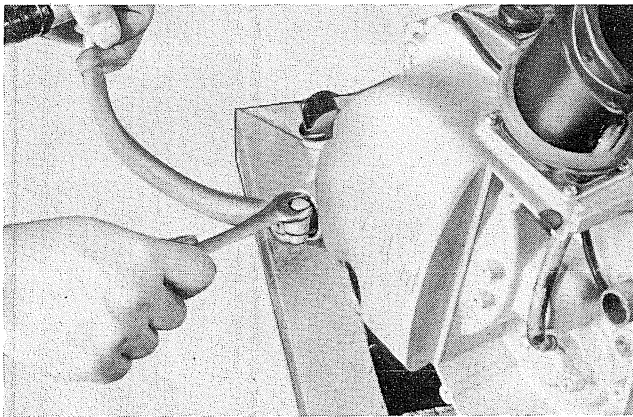

Fig. 3-7-1

- 2) Remove the banjo bolt from the pump delivery pipe valve cover. (Fig. 3-7-2)
(The crankcase cover can be removed without removing the oil pump.)

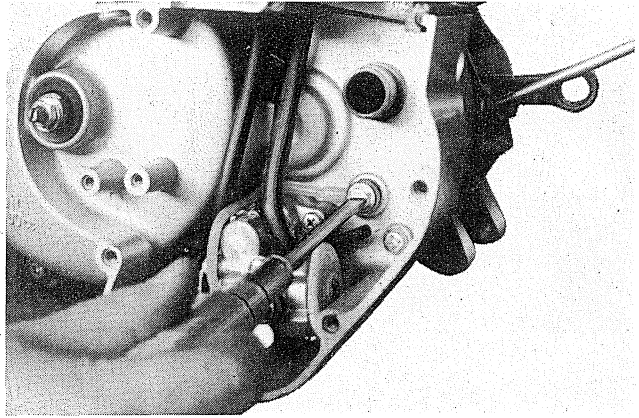

Fig. 3-7-2

- 3) Remove the pan-head screws from the crankcase cover (R), and take off the cover. (Fig. 3-7-3 and 4)

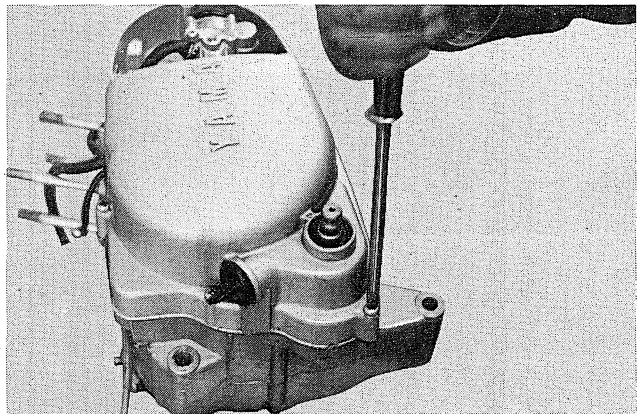

Fig. 3-7-3

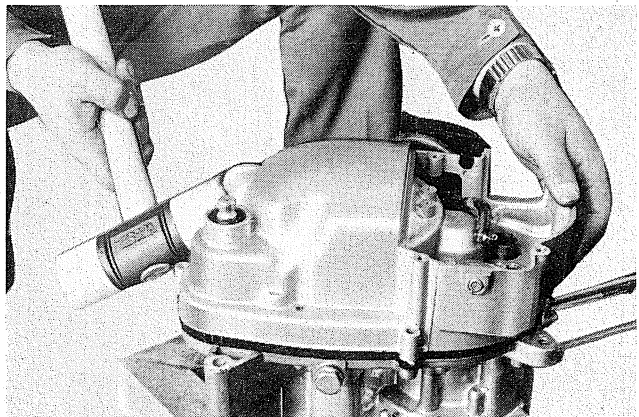

Fig. 3-7-4

ENGINE - Crankcase Cover (R)

- 4) Replace the crankcase cover gasket, if damaged. (Fig. 3-7-5)

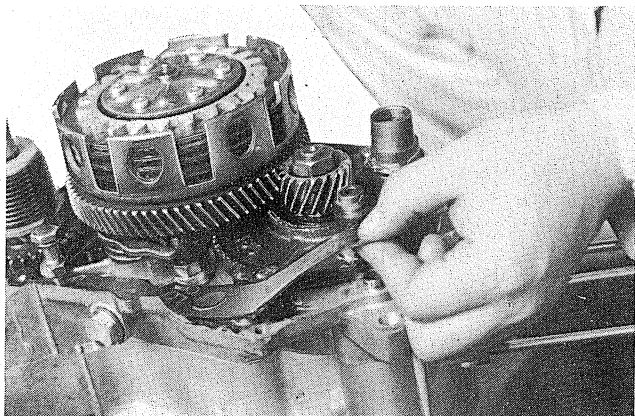

Fig. 3-7-5

B. Reinstallation

Apply the crankcase (R) sealing surface with gasket paste (Yamaha Bond No. 5); and place the crankcase cover gasket upon it, and then install the crankcase cover. (Fig. 3-7-6)

Be sure to apply Yamaha Bond No. 5 to prevent oil leakage.

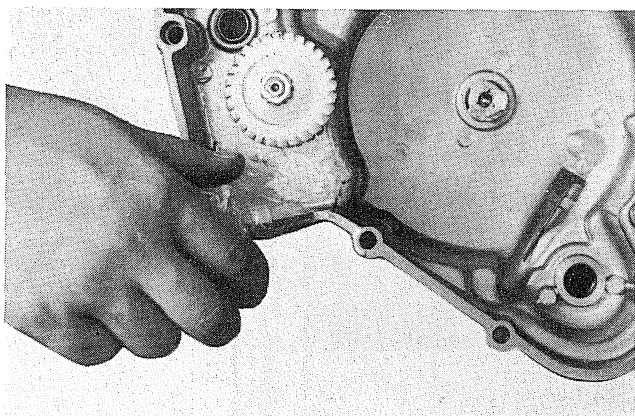

Fig. 3-7-6

3-8 Clutch

The clutch is a wet, multi-disc type, consisting of three molded cork friction plates and three clutch plates in the clutch housing mounted on the transmission main axle.

The clutch housing is integrated with the large reduction gear (primary driven gear), which is

driven by the small reduction gear (primary drive gear).

The primary drive gear and the primary driven gear have 19 and 74 teeth respectively, so that the primary drive reduction ratio is 3.894 : 1 ($74/19 = 3.894$).

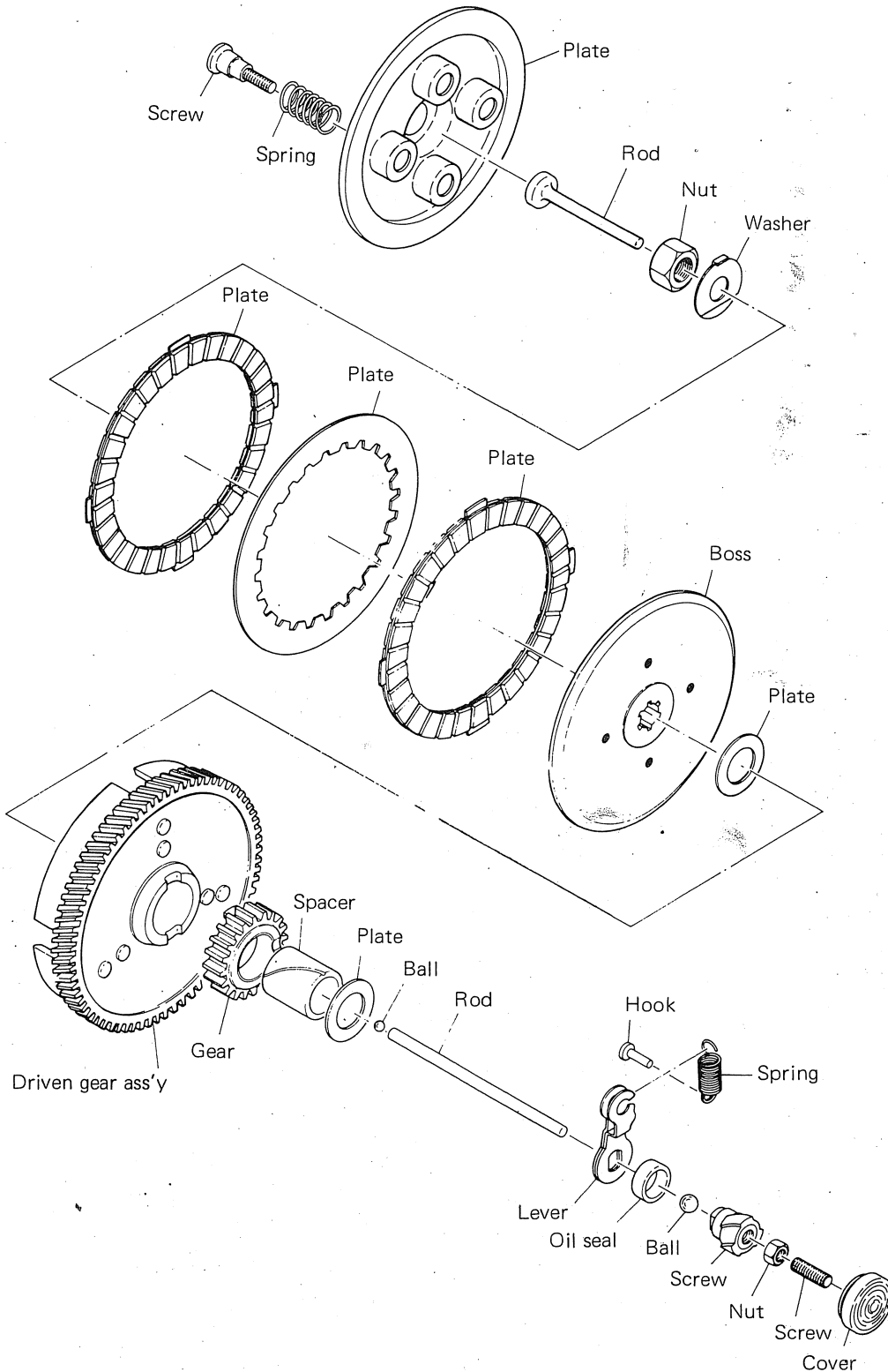

Fig. 3-8-1

A. Removing the Pressure Plate

Remove the six clutch spring holding screws, and remove the pressure plate 1. (Figs. 3-8-2 and 3)

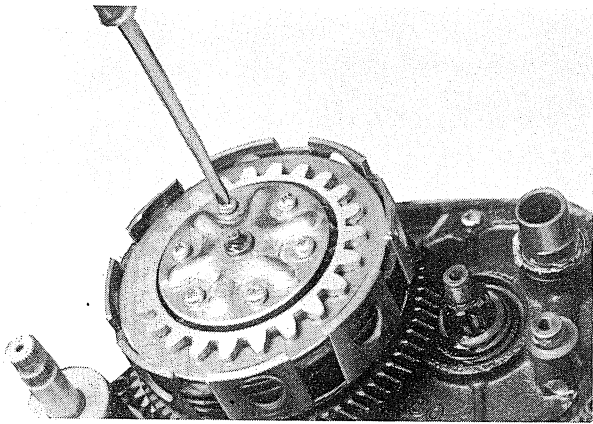

Fig. 3-8-2

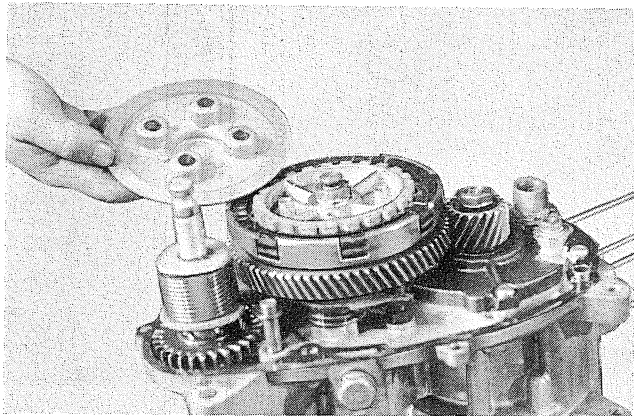

Fig. 3-8-3

B. Removing the Clutch Boss

To remove the clutch boss, fit the clutch holding tool on the clutch boss, and loosen the lock nut. (Fig. 3-8-4)

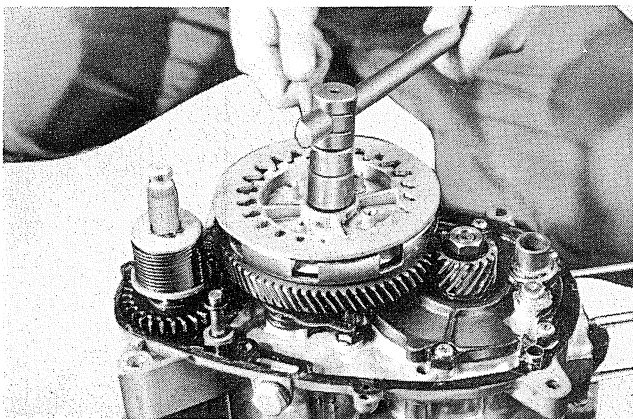

Fig. 3-8-4

C. Checking Clutch Springs

Measure the free length of each clutch spring, and replace any spring more than 1 mm shorter than the standard free length. (Figs. 3-8-5 and 6)

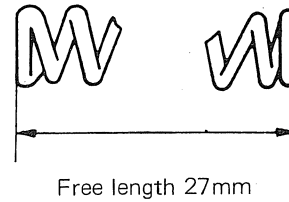

Fig. 3-8-5

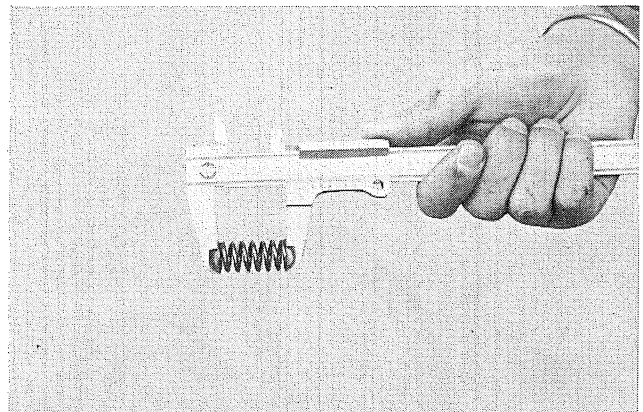

Fig. 3-8-6

D. Checking the Friction Plates

Friction plates are not everlasting, so that plates worn more than 0.3 mm under the standard thickness or showing uneven contact with the clutch plates should be replaced. (Figs. 3-8-7 and 8)

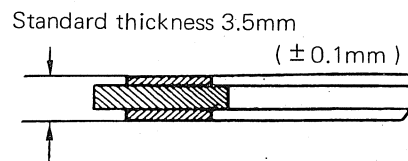

Fig. 3-8-7

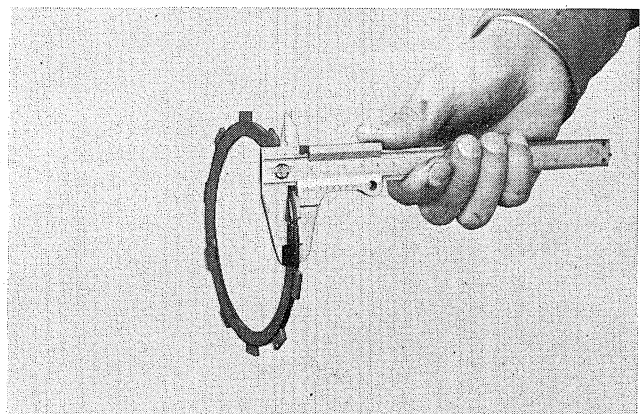

Fig. 3-8-8

E. Clutch Housing Ass'y (Integrated with the Primary Driven Gear)

A rubber thrust cushion O-ring is fitted between the clutch housing and the primary driven gear to eliminate the transfer of gear noise at low speed revolution.

1) Checking

Insert the primary gear retaining collar in the primary driven gear boss, and check it for radial play and scratch that could cause noise. If any scratch is found, smooth it out with an oil stone or fine grain sandpaper, because it will impair clutch action. If the play is excessive, replace the gear retaining collar because it will cause excessive noise. (Fig. 3-8-9)

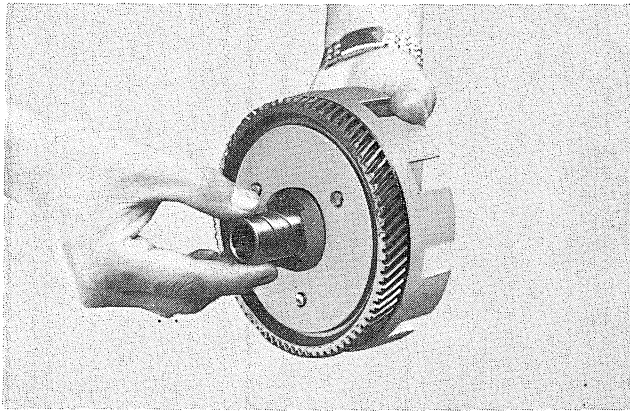

Fig. 3-8-9

F. Checking the Primary Gear Spacer

Place the primary gear retaining collar around the main axle, and again check it for radial play. If play exists, replace the gear retaining collar.

Replace any collar with step-wear on its outer surface. (Fig. 3-8-10)

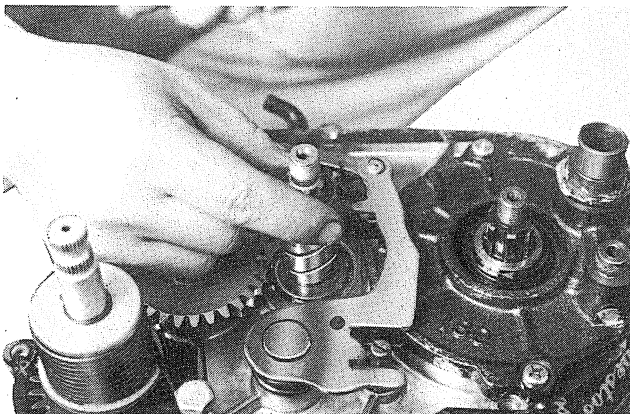

Fig. 3-8-10

G. Caution on Reassembling the Clutch-

On both ends of the primary gear spacer are thrust washers. If these washers are incorrectly installed, or omitted, the clutch boss will directly contact with the primary driven gear, impairing clutch actions.

Before fitting the clutch boss, install the clutch plates, friction plates, and then install the clutch boss. For this installation, the markings painted should be aligned.

H. Adjusting the Clutch

1) Remove the rubber cap and loosen the push screw lock nut.

Fasten the push screw to a lightly seated position, and back it off 1/4 turn to set the screw. Then fully tighten the lock nut. (Fig. 3-8-11)

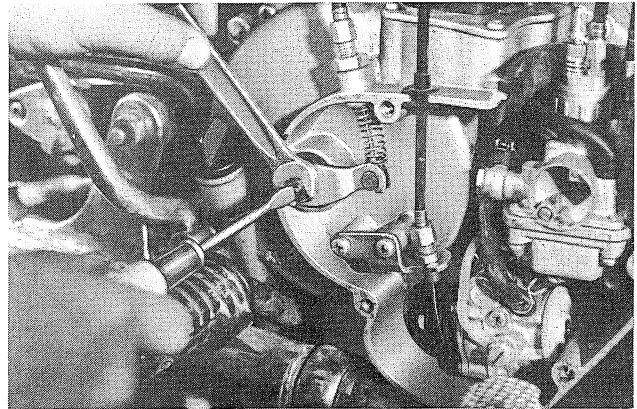

Fig. 3-8-11

2) Adjusting Clutch Cable Tension

The clutch cable becomes slackened after being used for a long time. Adjust the cable so that the play of the clutch handle is from 2 to 3 mm. (1/16 ~ 1/8") (Fig. 3-8-12)

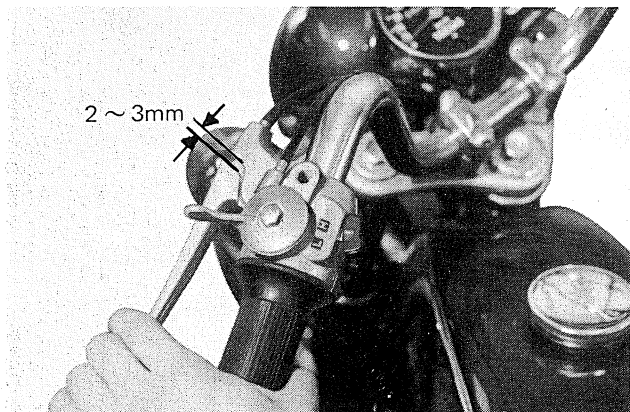

Fig. 3-8-12

ENGINE - Primary Drive Gear

- 3) Adjustment (Fig. 3-8-13)
 - a. Loosen the lock nut (a) fitted on the crankcase cover (L).
 - b. To reduce lever play, loosen the adjusting screw, and tighten it to increase play.
 - c. After the adjustment, tighten the lock nut.

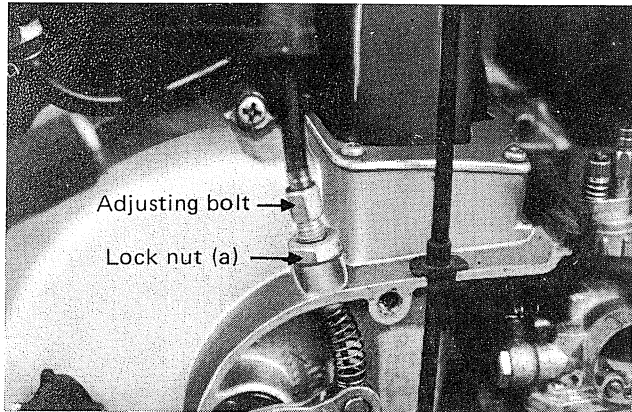

Fig. 3-8-13

3-9 Primary Drive Gear

- 1) Removal

Feed a rolled-up rag between the teeth of the primary drive gear and primary driven gear to lock them, and loosen the primary drive gear lock nut. (Fig. 3-9-1)

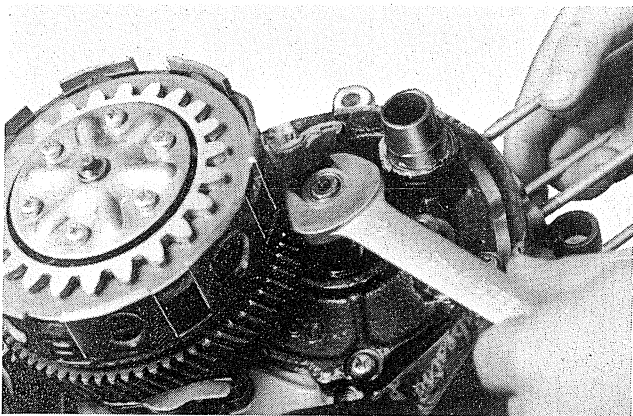

Fig. 3-9-1

3-10 Kickstarter

A. Removal

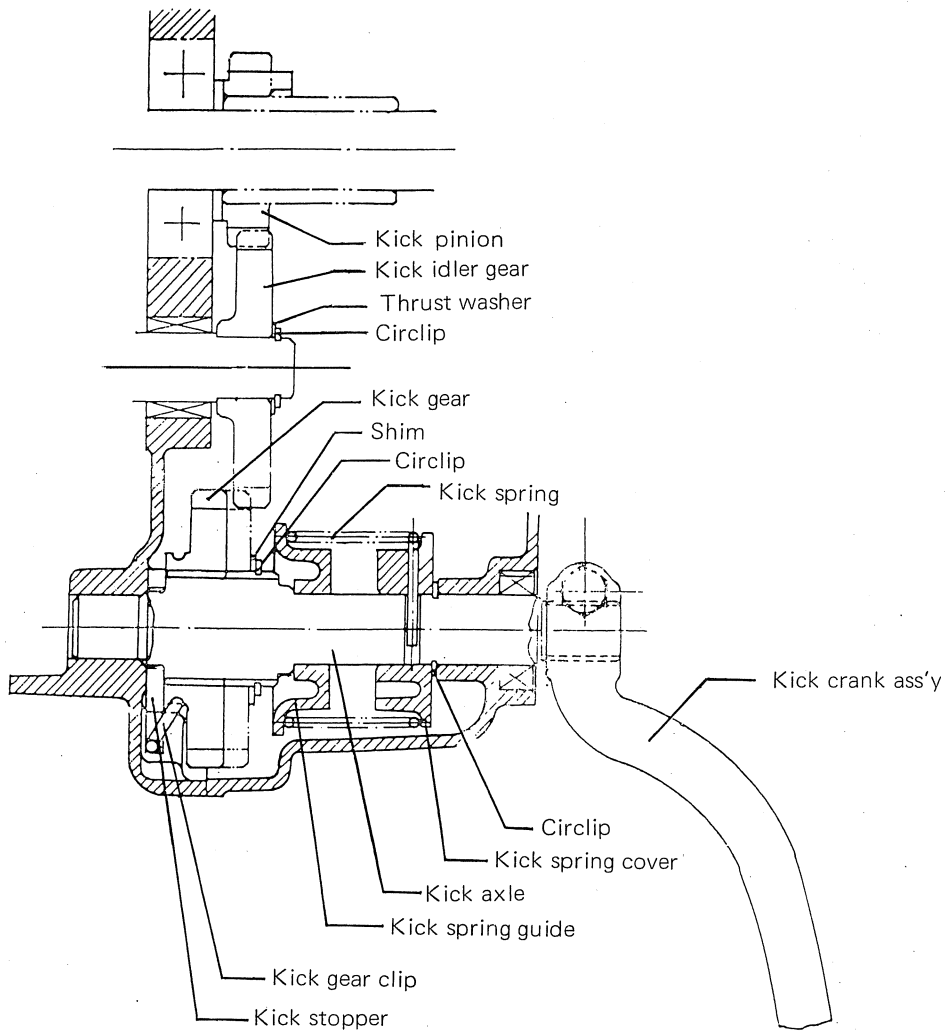

Fig. 3-10-1 Kick Cross Section

Mechanism

The primary kick-starter system (one-touch kick-starter) is employed. However, a new "non-constant-mesh" mechanism has been introduced into the F5/J5, FS1 & G5G Kick-starter, instead of the constant-mesh kick gear type, such as the ratchet and roller-rock systems.

That is, the kick gear meshes with idler gear only when the kick starter pedal is kicked. After the engine is started, the kick gear is off the idler gear. This mechanism not only eliminates noise resulting from the constant mesh of the kick gear with the idler gear, but also greatly contributes to the durability of the kick starter assembly.

ENGINE - Kickstarter

As the kick starter axle is turned, the kick gear splined to the kick axle having spiral splines on its surface is slid upward along the axle. (In this case, the kick gear moves only axially without rotating by means of the kick gear clip fitted in the kick gear.)

When the kick gear moves upward, teeth of the kick gear may clash against teeth of the idle gear in most cases. (although there will be possibility of smooth meshing without clashing.)

The kick gear clip is designed to absorb the impact of clashing, and at the same time, cause the kick gear to rotate so that the kick gear will smoothly come into mesh the idle gear.

(Refer to Figs. 3-10-2 and 3) After the kick gear has meshed with the idle gear, the kick gear is further slid upward without rotating. At the instant that the back of the kick gear contacts with the circlip the thrust load is imposed on the kick gear, thereby giving it turning force and rotating the crankshaft to start the engine.

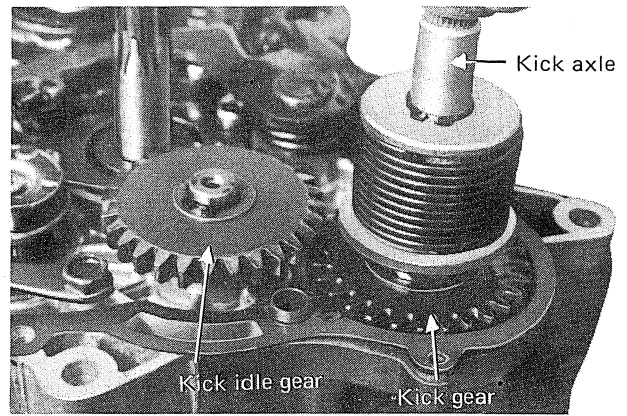

Fig. 3-10-2 In no kicking

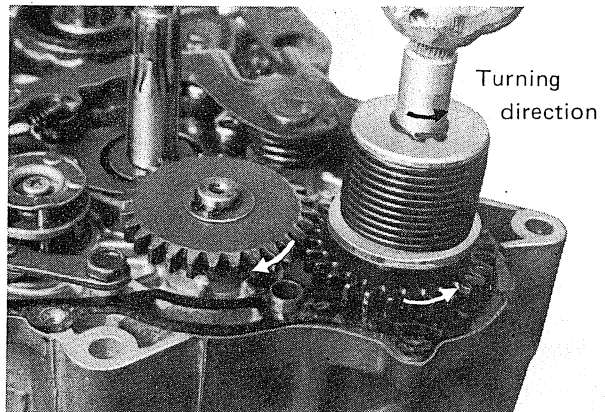

Fig. 3-10-3

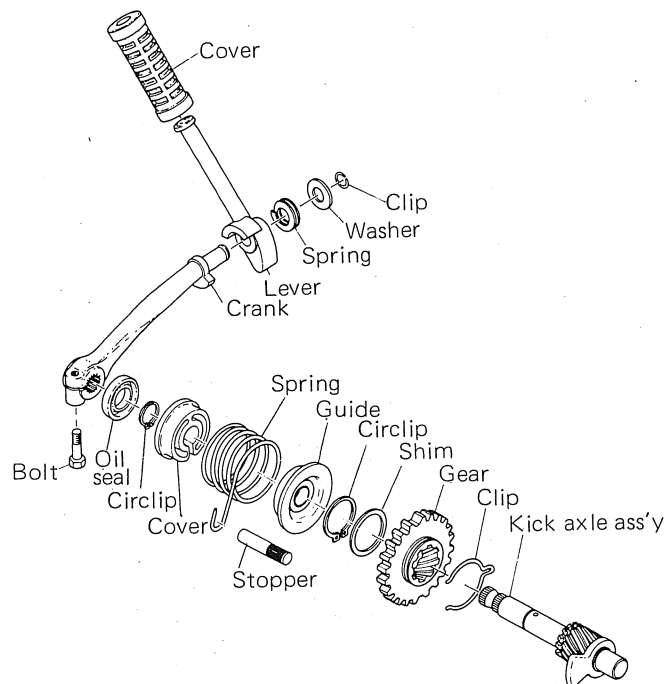

Fig. 3-10-4 Exploded View of the Kickstarter

- 1) Detach the spring from kick axle and remove the spring. (Fig. 3-10-5)

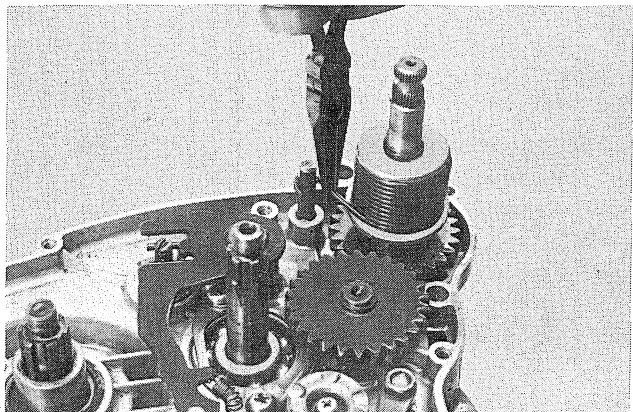

Fig. 3-10-5

- 2) Remove the kick starter assembly in the manner as shown in right. (Fig. 3-10-6)

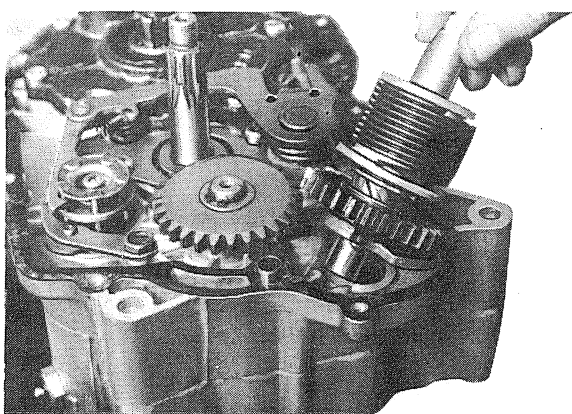

Fig. 3-10-6

B. Removing the Kick Idler Gear

Remove the clip with pliers, and the kick idler gear can easily be removed. (Fig. 3-10-7)

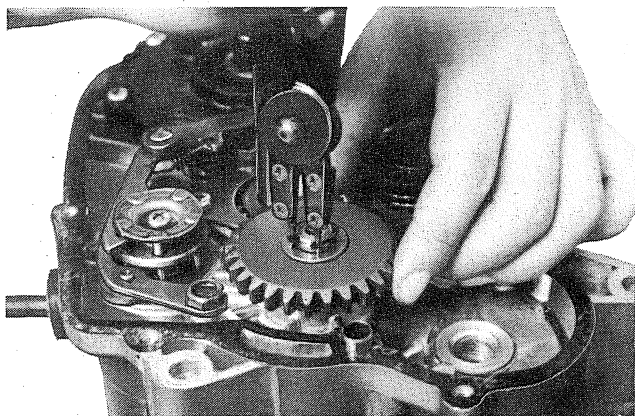

Fig. 3-10-7

3-11 Shifting Mechanism

Construction and Operation

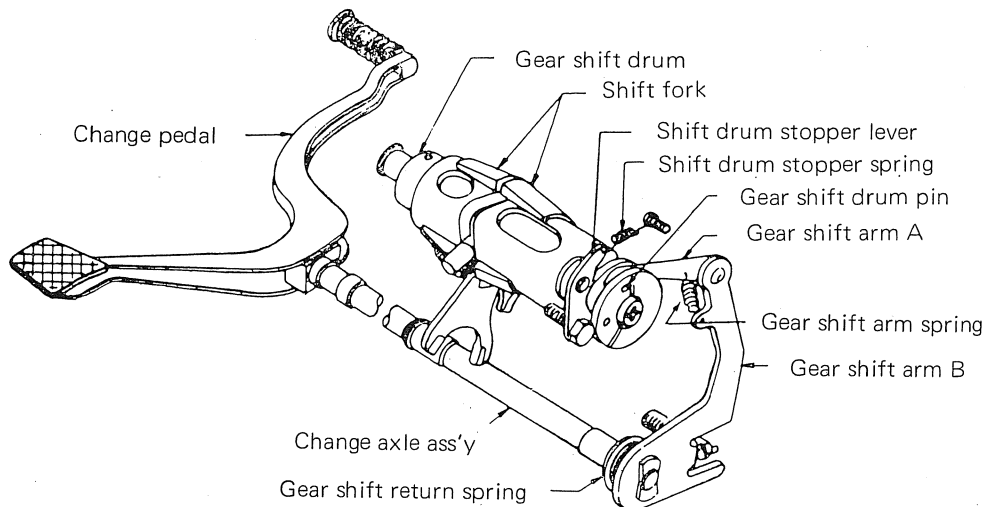

Fig. 3-11-1 Shifting Mechanism

When the gear shift lever is depressed, the gear shift arm B moves the gear shift arm A back and forth, and the gear shift arm A pushes the gear shift drum pins mounted on the gear shift drum, thus turning the gear shift drum.

The gear shift drum is equipped with five gear shift drum pins, and designed to make 1/5 turn each time the gear shift lever is depressed. In other words, one full turn of the drum will shift the

transmission at five stages: neutral low, second, third and top.

The gear shift pins are held by the disc so that the stopper plate may secure each position of the five stages.

The outer surface of the gear shift drum is provided with a groove, along which the shift forks travel back and forth for shifting the gear.

A. Removing the Change Axle Ass'y

To pull off the gear shift arm A, remove the left circlip and washer, and push up the gear shift arm A from the right side of the engine. (Figs. 3-11-2, 3 and 4)

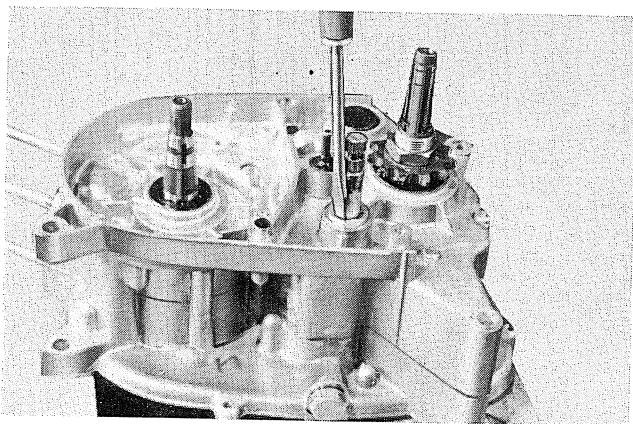

Fig. 3-11-2

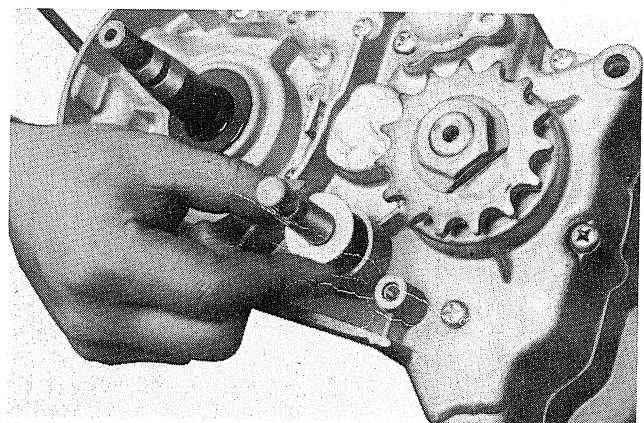

Fig. 3-11-3

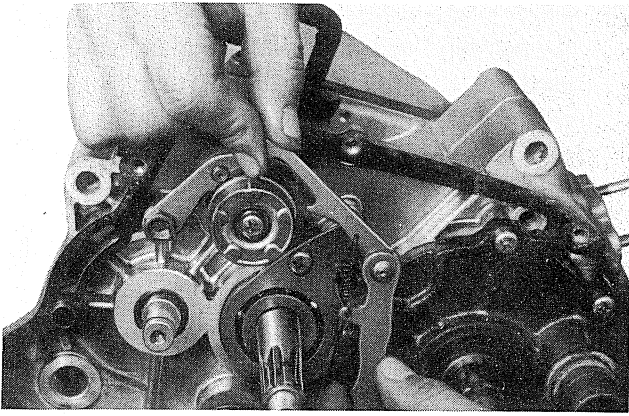

Fig. 3-11-4

B. Checking Change Axle Parts

(Fig. 3-11-5)

- 1) **Checking the Gear Shift Return Spring**
Check the gear shift return spring for fatigue and damage. Any broken or fatigued gear shift return spring will impair the returning action of the shifting system.

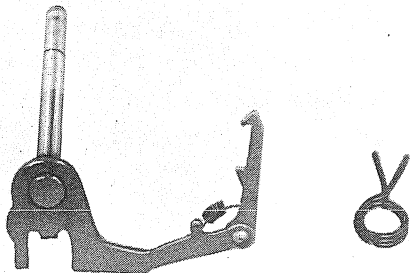

Fig. 3-11-5

- 2) Any broken or fatigued gear shift arm spring will impair shifting actions.

C. Gear Shift Arm

- 1) **Removal**

Remove the gear shift arm mounting bolt. (Fig. 3-11-6)

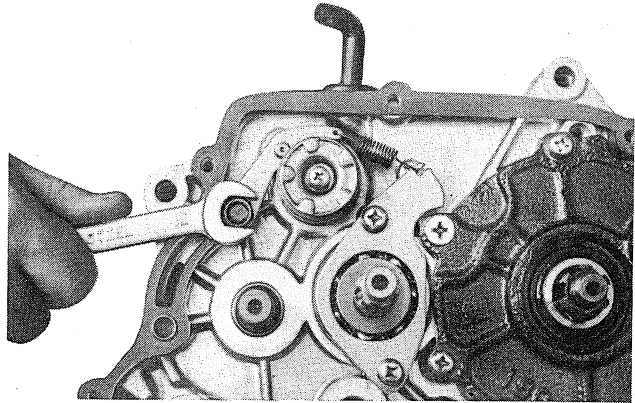

Fig. 3-11-6

- 2) **Checking the Gear Shift Arm Spring**
Any fatigued or broken gear shift arm spring may cause the gear shift arm to skip shift drum pins. Check the spring, and replace it if weakened or broken.

3-12 Rotary Valve

A. Removal

- 1) Remove the valve cover mounting bolts and remove the valve cover. (Fig. 3-12-1)

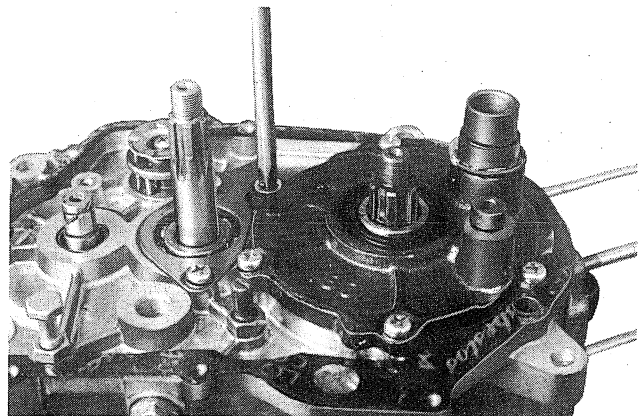

Fig. 3-12-1

- 2) Removing the Valve Knock Pin
As shown in Fig. 3-12-2, push out the valve knock pin from the other side, with a nail or wire. Be careful not to damage the crankcase surface. (Fig. 3-12-2)

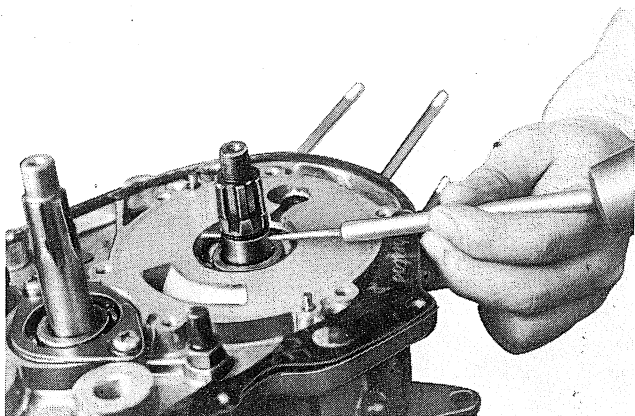

Fig. 3-12-2

B. Checking

- 1) Valve and Valve Unit Collar
Fit the valve over the valve unit collar and check for play. If play is excessive, replace the valve. (Fig. 3-12-3)

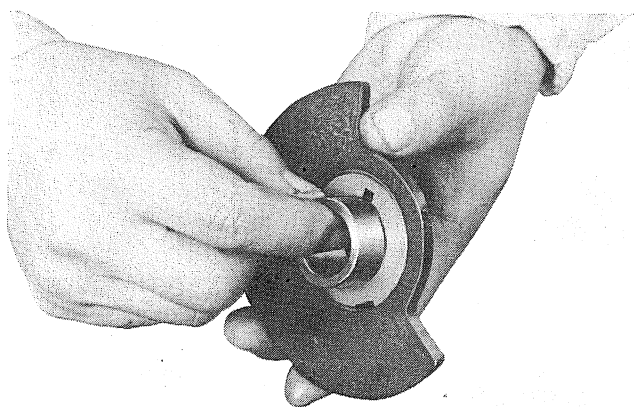

Fig. 3-12-3

If the valve unit collar is worn with step, replace it.

- 2) Valve Cover O-ring
O-rings tend to stretch slightly after being used for a long time. A stretched O-ring will not fit in the groove perfectly, and should be replaced. When installing the O-ring, grease it so that it sticks to the valve cover, thus facilitating the installation. (Fig. 3-12-4)

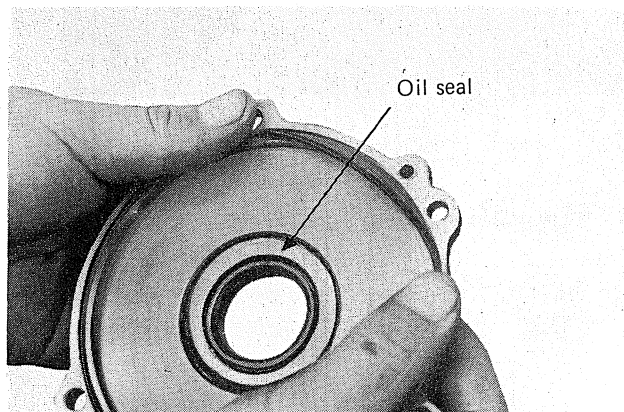

Fig. 3-12-4

- 3) Crankshaft O-ring
The crankshaft O-ring may easily get scratched when it is installed in the valve unit collar. Replace it if damaged. When installing the valve unit collar, take care not to scratch the O-ring. For this purpose, grease the O-ring before installation. (Fig. 3-12-5)

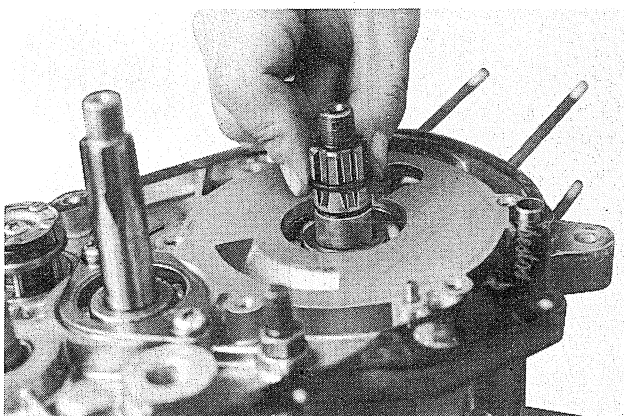

Fig. 3-12-5

- 4) Valve Cover Oil Seals
Apply grease of good quality to the lip surface when replacing the oil seal. (Fig. 3-12-6)

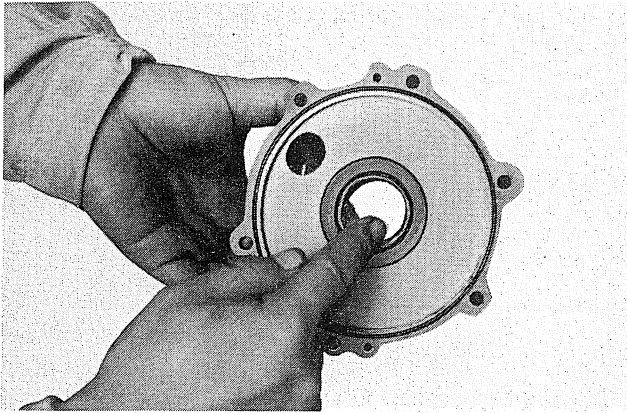

Fig. 3-12-6

- 5) Note on Assembling (F5/J5, FS1)
Align the match mark of the valve with the locating pin on the crankshaft as shown in the figure below. (Fig. 3-12-7)

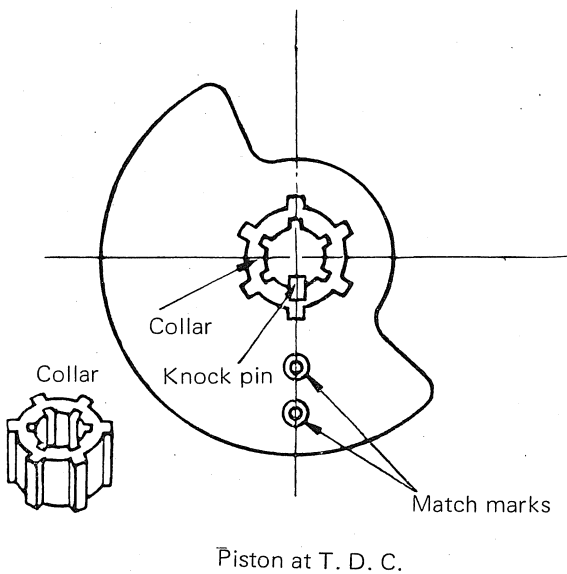

Fig. 3-12-7

3-13 Drive Sprocket

A. Removal

- 1) Straighten the bent edge of the lock washer, with a chisel. (Fig. 3-13-1)

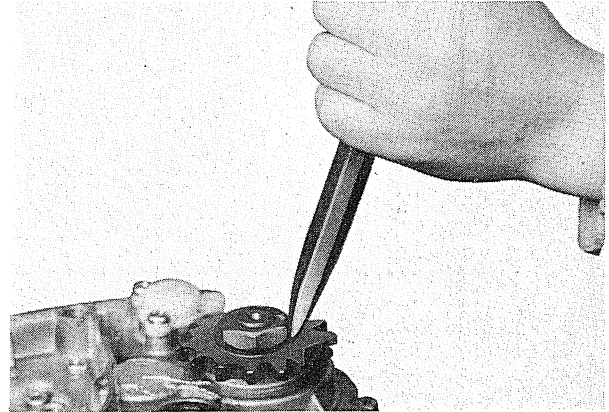

Fig. 3-13-1

- 2) Lock the drive sprocket with the flywheel magneto holding tool, and loosen the sprocket nut. (Fig. 3-13-2)

If no flywheel magneto holding tool is available, shift the transmission into low gear, and fit a socket wrench on the sprocket nut. Then tap the holder of the wrench with a hammer so that the nut can be loosened.

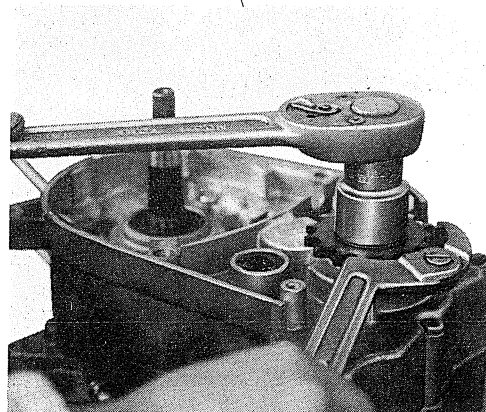

Fig. 3-13-2

B. Checking the Drive Sprocket

Any worn drive sprocket may result in excessive noise and shorten the life of the chain.

Check the sprocket, and replace it if worn. (Fig. 3-13-3)

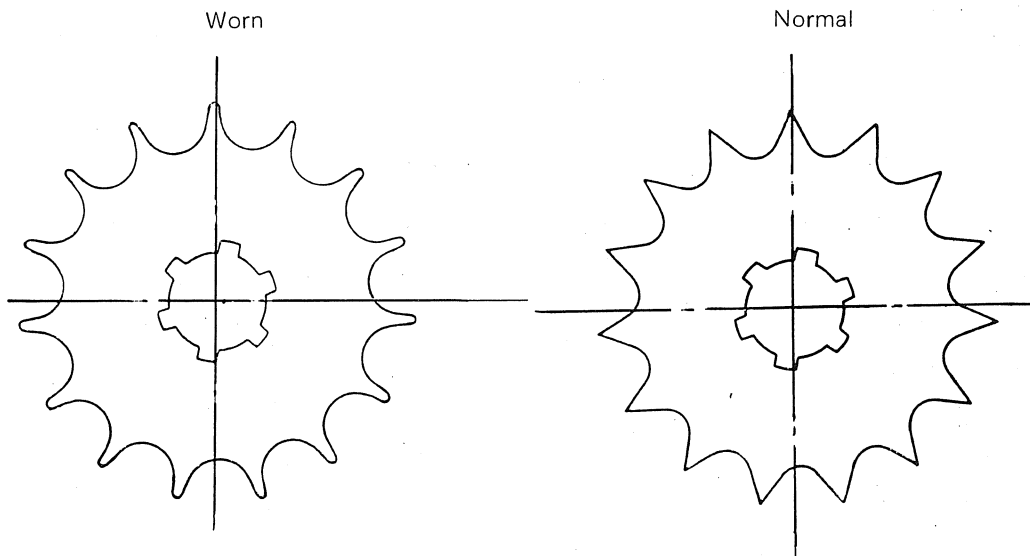

Fig. 3-13-3

3-14 Splitting the Crankcase Halves

A. Splitting

The crankcase may be split from either side, but to facilitate the subsequent servicing operations, the dividing tool should be installed on the right half of the crankcase.

1) Remove the pan-head screw from the left side half of the crankcase. (Fig. 3-14-1)

2) Install the crankcase dividing tool on the right half of the crankcase, and alternately tap the transmission main axle and the side of the right half with a plastic tip hammer, so that the crankcase can be divided into two halves. (Fig. 3-14-2 and 3)

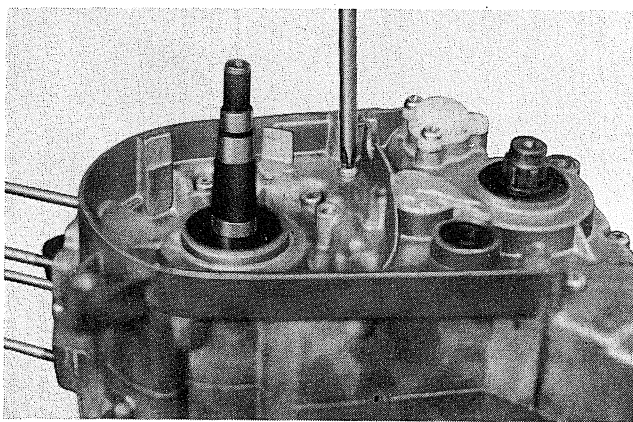

Fig. 3-14-1

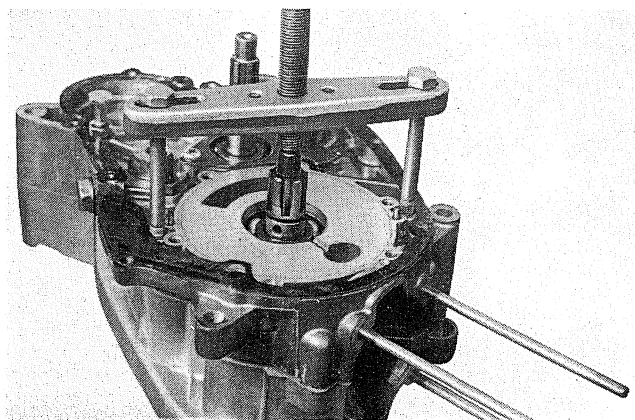

Fig. 3-14-2

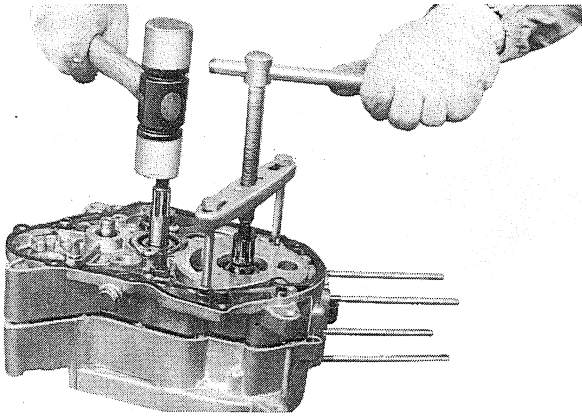

Fig. 3-14-3

Note:

Fully tighten the bolts of the dividing tool while keeping the body in a horizontal position.

B. Reassembling

When reassembling the crankcase, be sure to apply Yamaha Bond No. 5 to the mating surfaces of the crankcase. (Fig. 3-14-4)

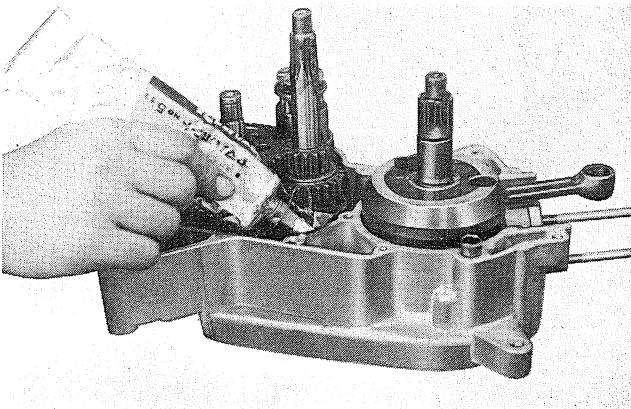

Fig. 3-14-4

FS1 Exploded View of Transmission

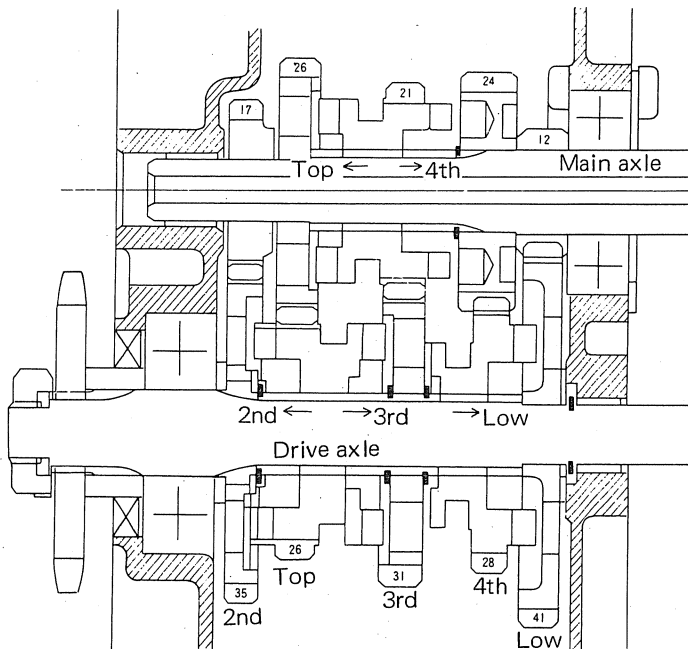
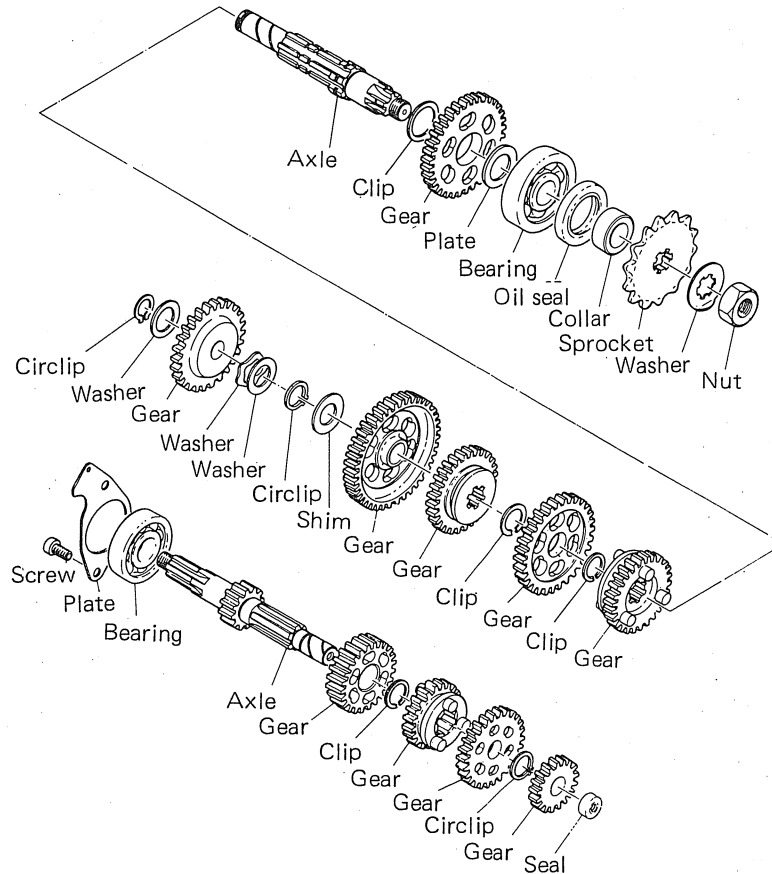

Fig. 3-15-2

Primary reduction ratio	$74/19 = 3.894$
Secondary reduction ratio	$41/15 = 2.733$
Gear ratio Low	$41/12 = 3.417$
2nd	$35/17 = 2.059$
3rd	$31/21 = 1.476$
4th	$28/24 = 1.167$
Top	$26/26 = 1.000$

ENGINE - Transmission Assembly

For arrangement and component parts of the transmission, refer to Figs. 3-15-1 and 2.

A. Removal

- 1) Remove the shift drum seal cover and clip. (Figs. 3-15-3 and 4)

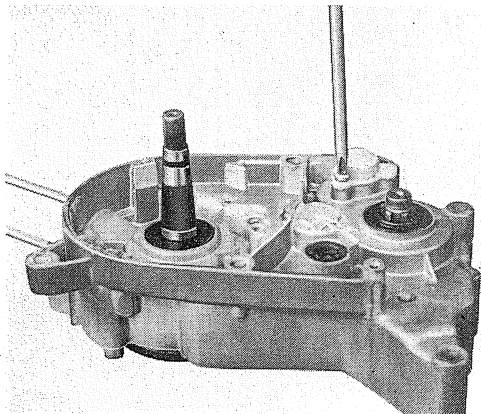

Fig. 3-15-3

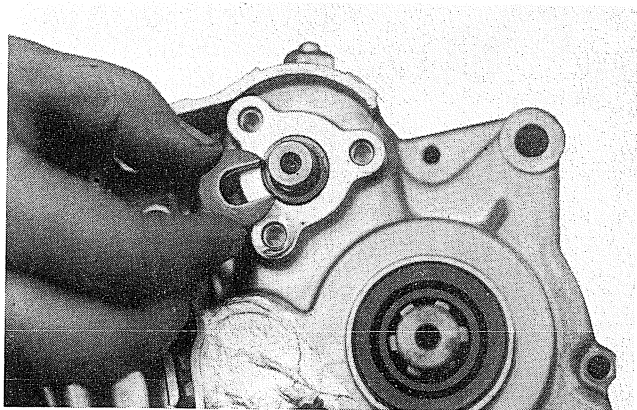

Fig. 3-15-4

- 2) Remove the transmission and the shifter at the same time. (Fig. 3-15-5)

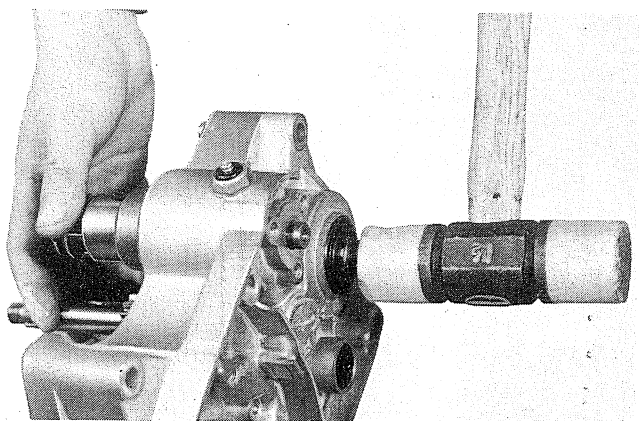

Fig. 3-15-5

B. Reinstallation

Reverse the above procedures for reinstallation, but be sure to put all washers in their proper places.

First assemble the transmission and shifter, and then fit it into the crankcase.

3-16 Crankshaft

Of all engine parts, the crankshaft requires the highest degree of accuracy in engineering, manu-

facturing and servicing. The crankshaft is "delicate", so handle it very carefully.

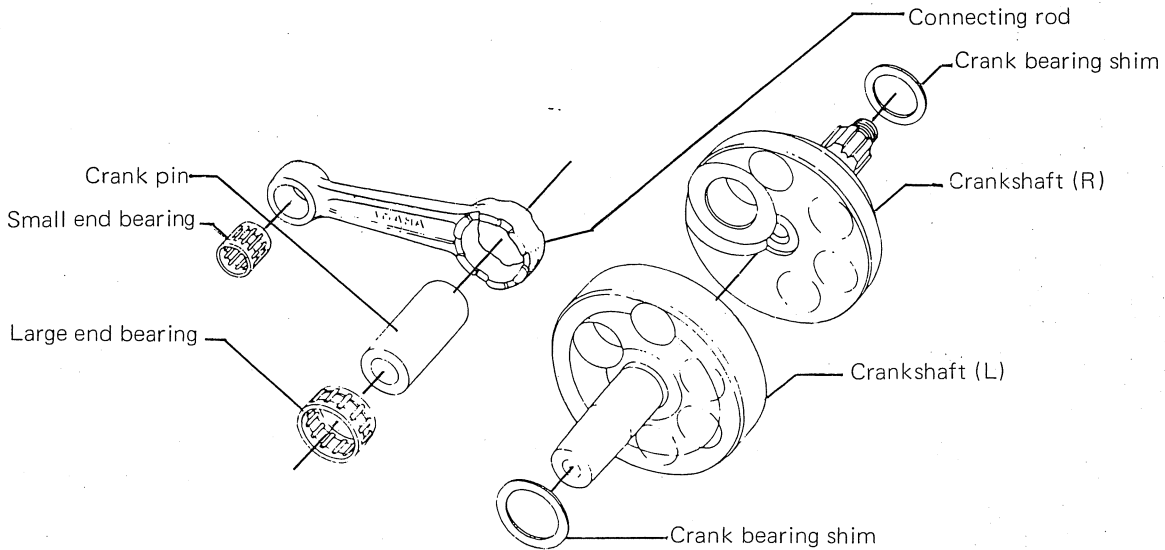

Fig. 3-16-1 Crankshaft Components

A. Dimensions of Crankshaft Ass'y

	A		B	C
	F5/J5	38	-0.05 -0.10 mm	15 mm
G5G	45	-0.05 -0.10 mm	18.5 mm	200 mm
FS1	38	-0.05 -0.10 mm	15 mm	180 mm

Fig. 3-16-2

B. Removing the Crankshaft Ass'y

- 1) Remove the crankshaft ass'y, with the crankcase disassembling tool. (Fig. 3-16-3)

Note:

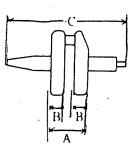
Fully tighten the bolts of the disassembling tool, and keep the tool body in a horizontal position.

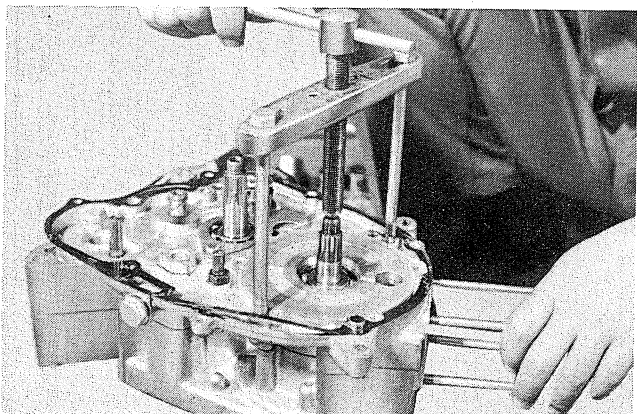

Fig. 3-16-3

C. Reinstalling the Crankshaft Ass'y

Put shims on both ends of the crankshaft, and reinstall the crankshaft by using the crankshaft assembling tool (for 50U5 and YG1). Hold the connecting rod at top dead center with one hand while turning the handle of the installing tool with the other so that the connecting rod will not contact the crankcase. (Fig. 3-16-4)

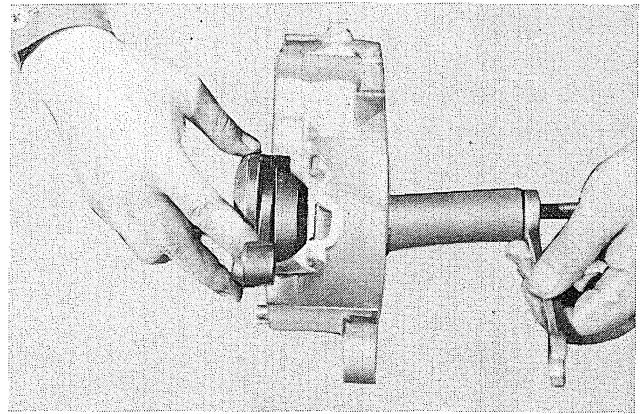

Fig. 3-16-4

D. Checking and Servicing

1) Checking the Crankshaft Components

<p>Check connecting rod axial play at small end (to determine the amount of wear of crank pin and bearing at large end). (Fig. 3-16-5)</p>	<p>Small end play should not exceed 2 mm.</p>	<p>If small end play exceeds 2 mm, disassemble the crankshaft, check connecting rod, crank pin and large end bearing. Replace defective parts. Small end play after reassembly should be within 0.8~1.0 mm.</p>
<p>Check the connecting rod for axial play at large end. (Fig. 3-16-6)</p>	<p>Move the connecting rod to one side and insert a feeler gauge. Large end axial play should be within 0.1~0.3 mm.</p>	<p>If excessive axial play is present, disassemble the crankshaft and replace any worn parts.</p>
<p>Check accuracy of the crankshaft ass'y. (Misalignment of parts of the crankshaft)</p>	<p>Dial gauge readings should be within 0.03 mm.</p>	<p>Correct any misalignment by tapping the flywheel with a brass hammer and by using a wedge.</p>

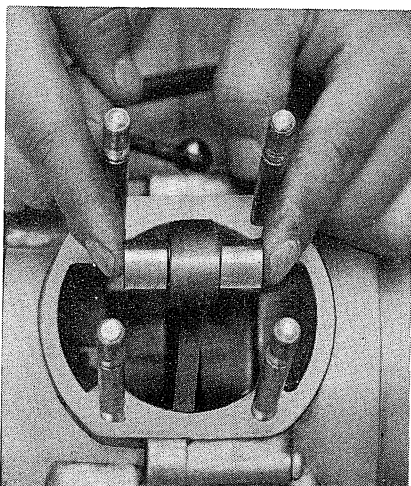

Fig. 3-16-5

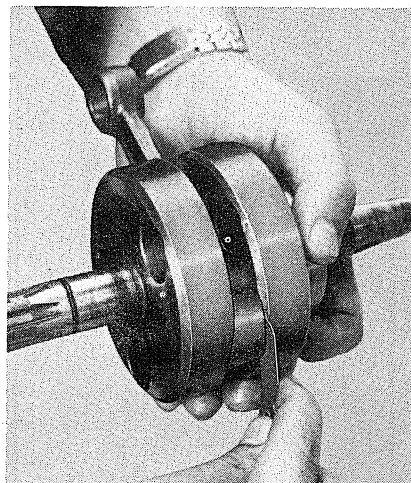

Fig. 3-16-6

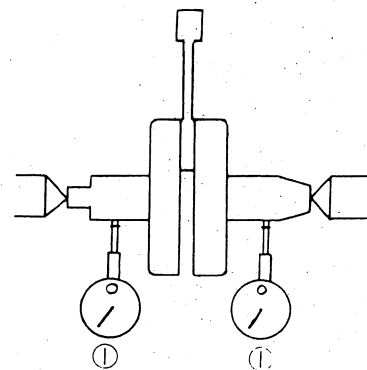

Fig. 3-16-7

3-17 Bearings and Oil Seals

A. Removal and Reinstallation

The crankcase should preferably be heated to approximately 120°C (250°F) to remove or install oil seals and bearings, but the following procedure is satisfactory.

1) Removal

- a. Pry the oil seals out of place with a slot head screwdriver. (Fig. 3-17-1)
Replace the oil seals when overhauling the engine.

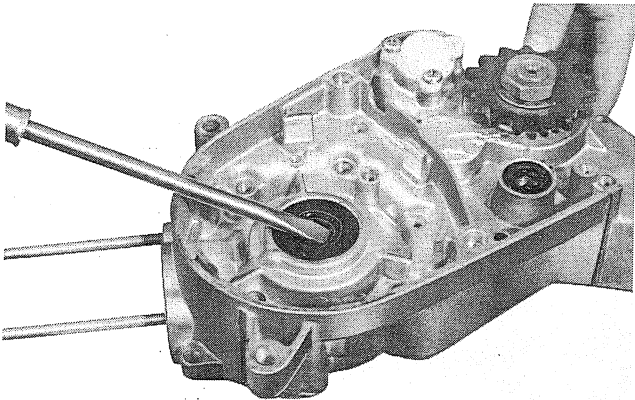

Fig. 3-17-1

- b. Remove the bearing with a bearing puller. (Fig. 3-17-2)

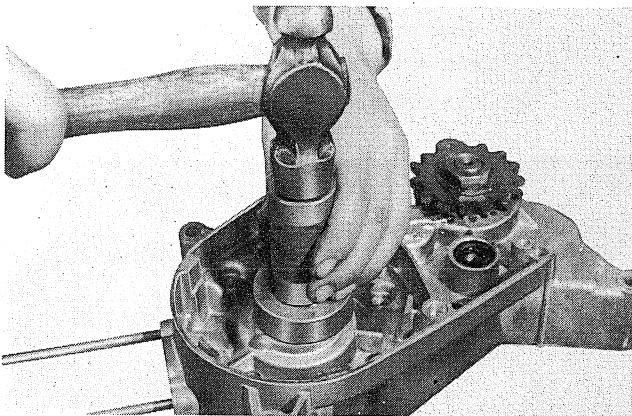

Fig. 3-17-2

2) Reinstallation

Install bearings and oil seals with their stamped manufacturer's marks or numerals facing outward. (In other words, the stamped letters must be on the exposed-to-view side.)

When installing them, grease them fully.

3-18 Carburetor

A. Checking the Carburetor

1) Float

If fuel leaks into the float while the engine is running, the float chamber fuel level will rise and make the combustion chamber fuel mixture too rich. Shake the float to check if gasoline is inside. Replace the float if it is deformed or leaking.

2) Float Valve

Replace the float valve if its seating end is worn with step or scratched. Check the float valve spring for fatigue. Depress the float valve with a finger, and make sure that it properly seats against the valve seat when released. If the float valve spring is weakened, fuel may overflow, flooding the float chamber while the machine is running at certain speeds or under certain road conditions.

3) Overflowing

If fuel overflows, check the carburetor as described in 1) and 2) above. If neither 1) nor 2) cures the overflowing, it may be caused by dirt or dust in the fuel, preventing the float valve from seating properly. If any dirt or dust is found, blow it off. (Figs. 3-18-1 and 2)

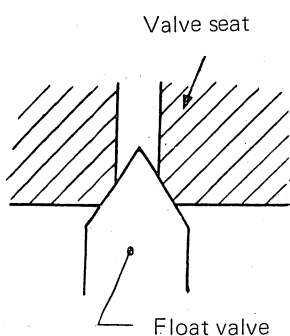

Fig. 3-18-1

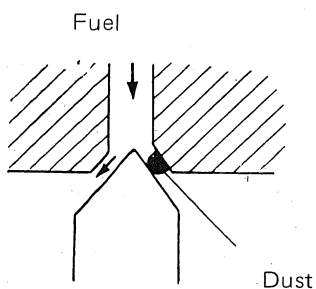

Fig. 3-18-2

4) Cleaning the Carburetor

Disassemble the carburetor, and wash all its parts in clean gasoline. Blow fuel passages in the carburetor with compressed air. All jets and other delicate parts should be cleaned by blowing compressed air through them, because cable or other hard, pointed cleaning tools may damage their precision-machined surfaces. (Fig. 3-18-3)

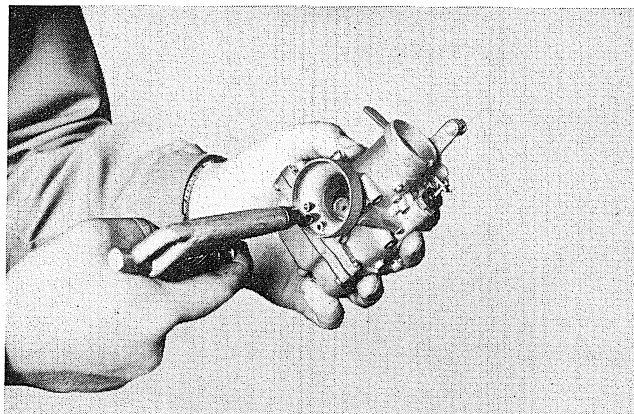

Fig. 3-18-3

B. Reconditioning the Carburetor

1) Idle Speed Adjustments

Idle speed adjustments should be performed after the engine is fully warmed up.

- a. Fully tighten the air screw, and keep the engine running at the lowest possible speed, and adjust the throttle stop screw. (Fig. 3-18-4)

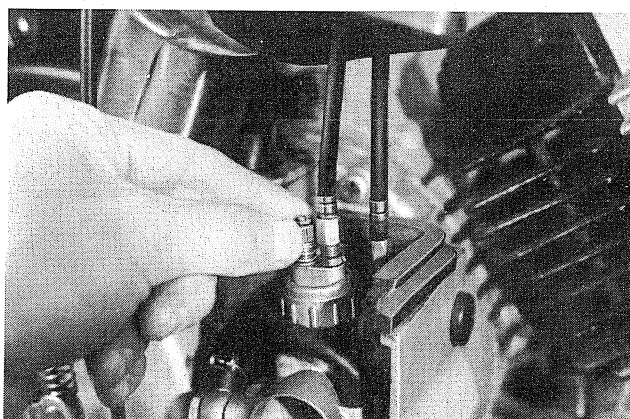

Fig. 3-18-4

- b. Back off the air screw slowly until the engine speed reaches its maximum and set the air screw.
(Fig. 3-18-5)

- c. Turn the throttle stop screw until the engine speed reaches its maximum, and set the screw. Repeat this operation 2 or 3 times until the carburetor is correctly adjusted.

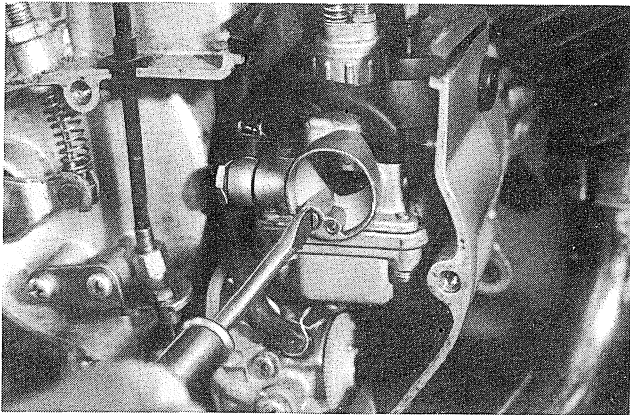

Fig. 3-18-5

2) Carburetor Setting

F5/J5	Export-except specific area	High lands
Model	VM16SC	VM16SC
Stamped mark	257E2	257H2
Main jet	150	130
Jet needle	3G9-3	3G9-3
Needle jet	E-4	E-4
Throttle valve cutaway	1.5	1.5
Pilot jet	25	20
Air screw back-off	1-3/4	2.0

G5G	Export-except specific area	Middle & Near East	High lands
Model	VM16SC	VM16SC	VM16SC
Stamped mark	206A4	206N1	206H4
Main jet	120	130	100
Jet needle	3G9-3	3G9-3	3G9-3
Needle jet	E-2	E-2	E-2
Throttle valve cutaway	2.5	2.5	2.5
Pilot jet	25	25	25
Air screw back-off	1-3/4	1-3/4	2.0

FS1	Export-except specific area	High lands
Model	VM16SC	VM16SC
Stamped mark	260A4	260H4
Main jet	150	130
Jet needle	3G9-3	3G9-3
Needle jet	E-4	E-4
Throttle valve cutaway	2.0	2.0
Pilot jet	25	20
Air screw back-off	1-1/4	1-3/4

3-19 Air Cleaner

A. Removal

The air cleaner is incorporated in the cleaner case above the engine. To detach the cleaner, remove the cleaner case cover. (Fig. 3-19-1)

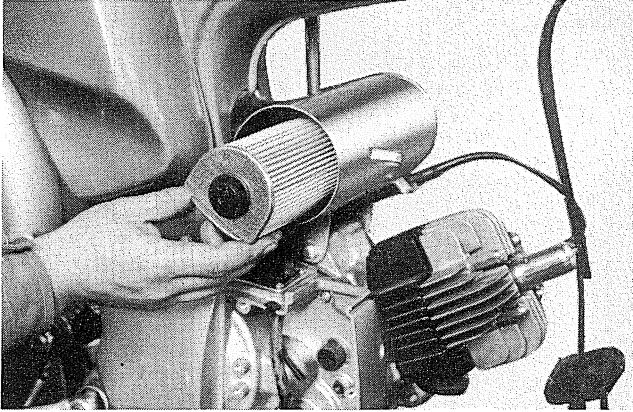

Fig. 3-19-1

B. Cleaning

Clean the filter element with compressed air. (Fig. 3-19-2)

The element is made of filter paper. It should be kept from water or oil.

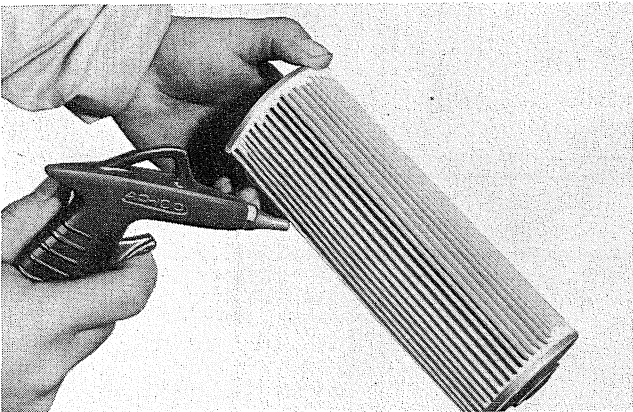

Fig. 3-19-2

3-20 Transmission Oil

Transmission oil amount Motor Oil SAE
10W/30 600 ~ 650 cc (0.64 ~ 0.68 qt.)

CHAPTER 4. CHASSIS

The Yamaha F5/J5, G5G and FS1 have been designed with an emphasis on improving the running stability and maneuverability. Their performance can well be comparable to conventional 90 cc class motorcycles. The 7-bone style frame assures improved rigidity and longer service life. To simplify servicing the rear wheel components, the separate type hub clutch has been employed. It can be said that they offer much better performance than any other makes of the same class.

4-1 Front Wheel

A. Structure

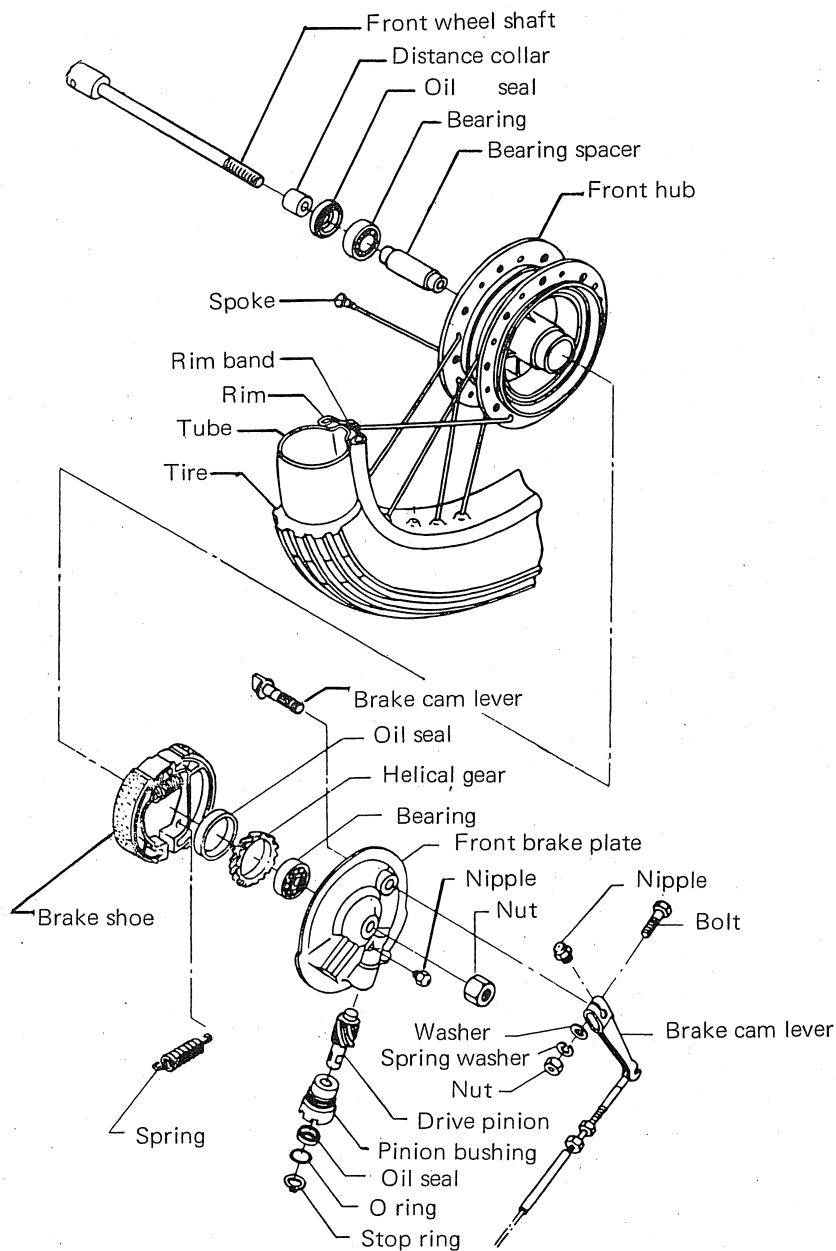

Fig. 4-1-1

CHASSIS - Front Wheel

B. Removal

- 1) Disconnect the front brake cable and speedometer cable from the front brake shoe plates. (Fig. 4-1-2)

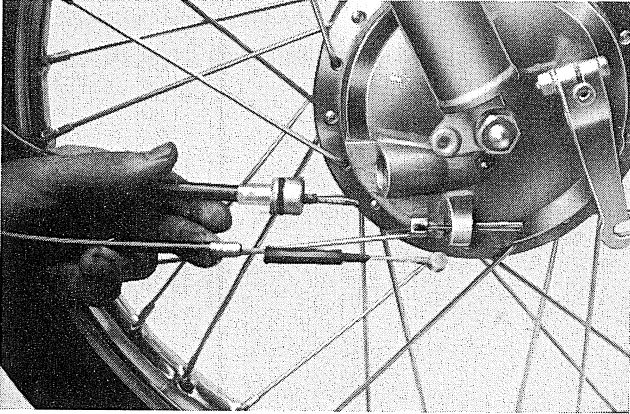

Fig. 4-1-2

- 2) Remove the front wheel nut, and pull out the wheel shaft. Then remove the distance collar. (Figs. 4-1-3 and 4)

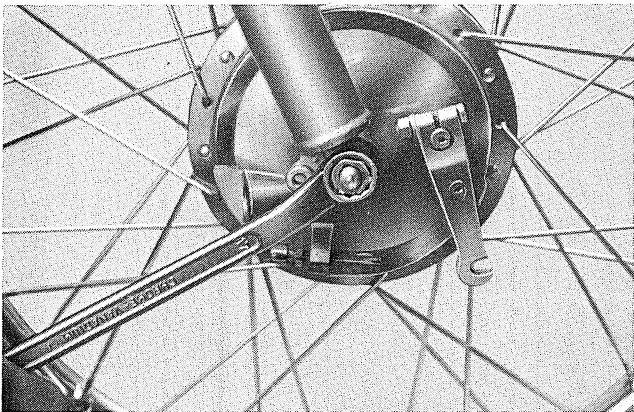

Fig. 4-1-3

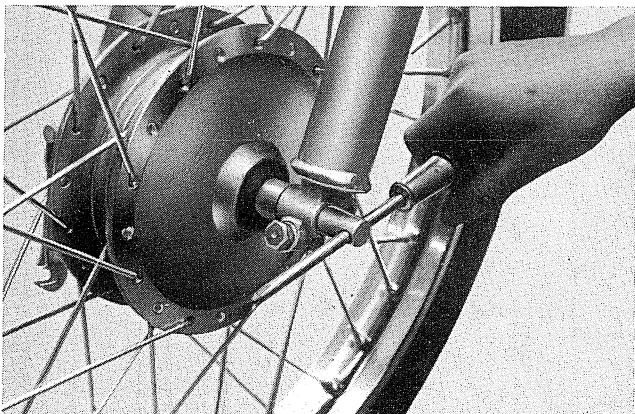

Fig. 4-1-4

When removing the distance collar, take care not to damage the oil seal lip. To remove the distance collar, grease it and turn it gently in or out.

- 3) Remove the front wheel ass'y. (Fig. 4-1-5)

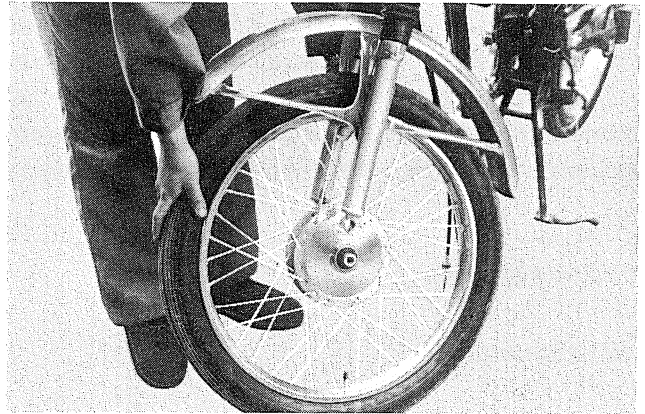

Fig. 4-1-5

C. Checking

- 1) Runout of the Rim

As shown in Fig. 4-1-5, measure the runout of the rim with a dial gauge.

Limit of runout . . . 3 mm (0.11 in.) or less (Fig. 4-1-6)

If necessary, adjust spoke tension or replace the rim.

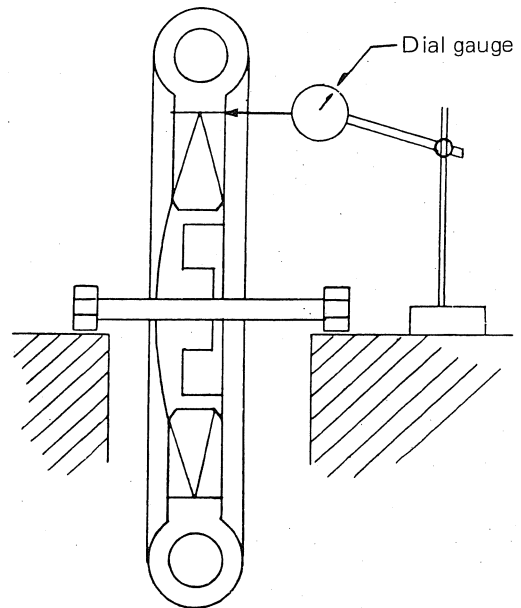

Fig. 4-1-6

2) Brake Shoe

Measure the outside diameter of the brake shoe with slide calipers. If it measures 105 mm (4.14") or less, replace it. (Fig. 4-1-7)

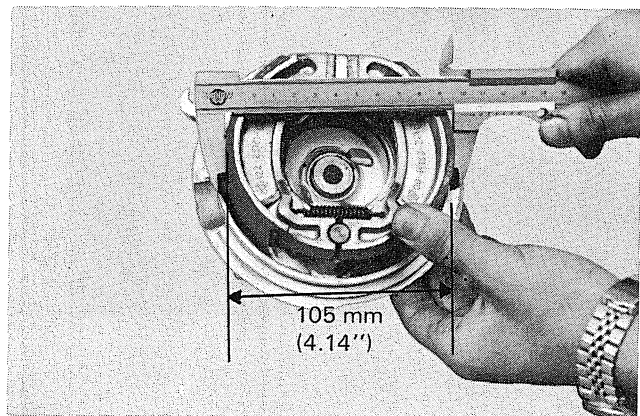

Fig. 4-1-7

3) Brake Drum

Oil or scratches on the inner surface of the brake drum will result in poor functioning or noise. Clean or smooth out the surface with a rag or sandpaper. (Fig. 4-1-8)

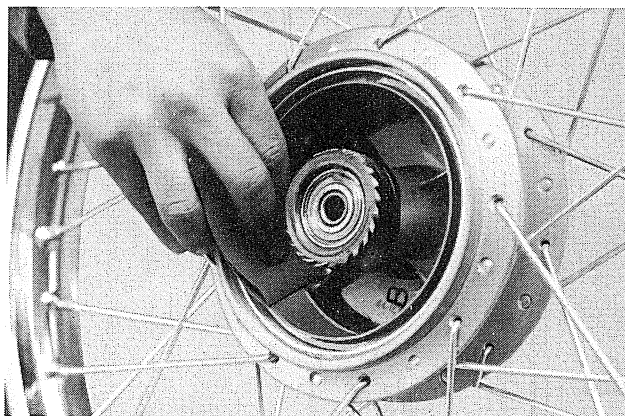

Fig. 4-1-8

4-2 Rear Wheel

A. Construction View

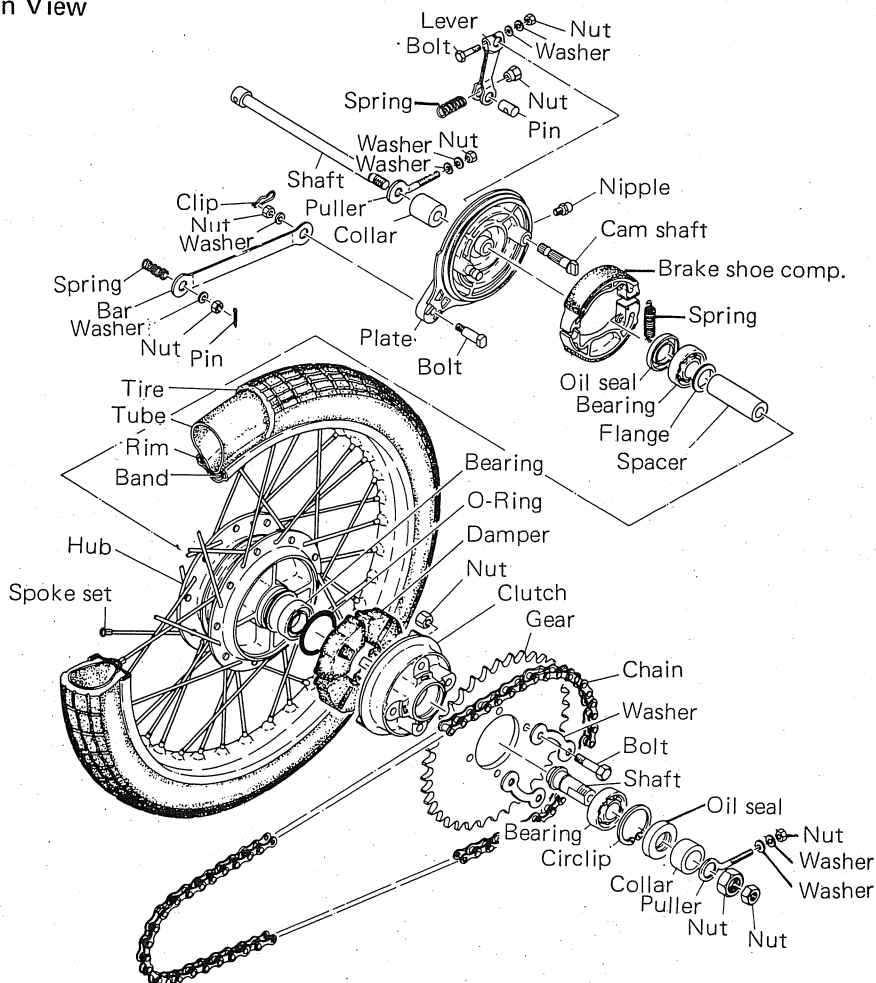

Fig. 4-2-1

CHASSIS - Rear Wheel

B. Removal

- 1) Remove the anchor bar and brake rod attached to the rear brake shoe plate. (Figs. 4-2-2, 3 and 4)

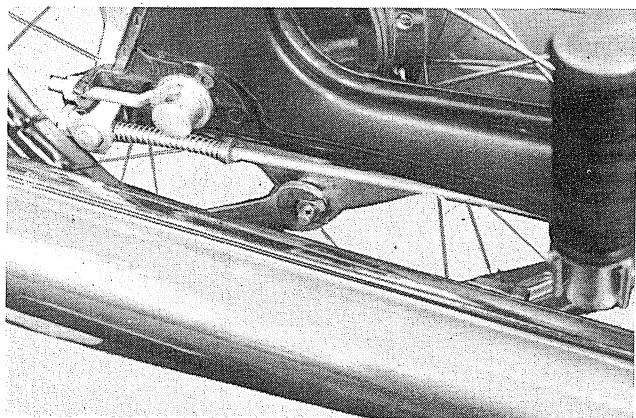

Fig. 4-2-2

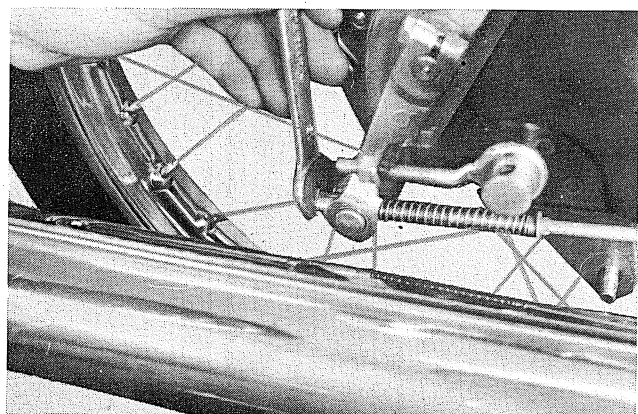

Fig. 4-2-3

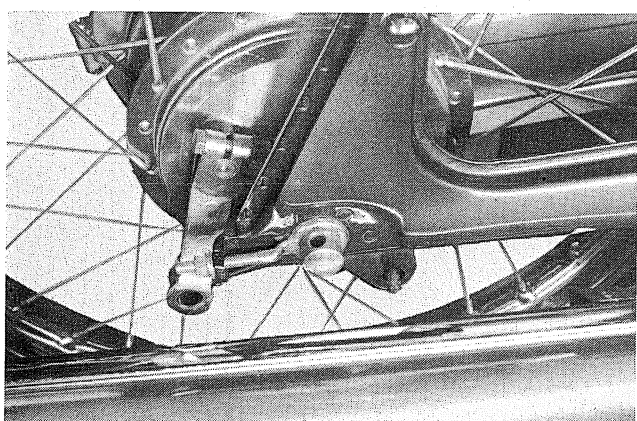

Fig. 4-2-4

- 2) Remove the nut and remove the rear wheel shaft. (Fig. 4-2-5)

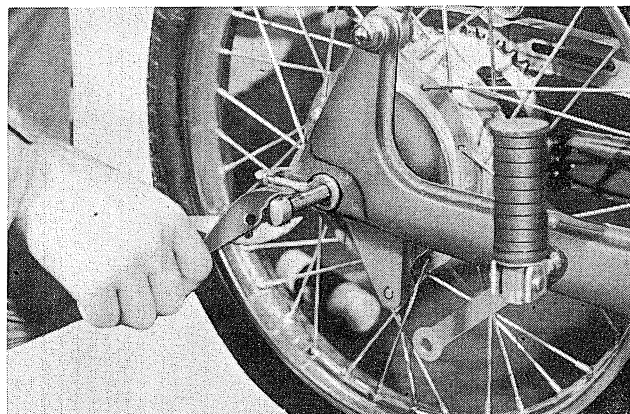

Fig. 4-2-5

- 3) Remove the distance collar. (Fig. 4-2-6)

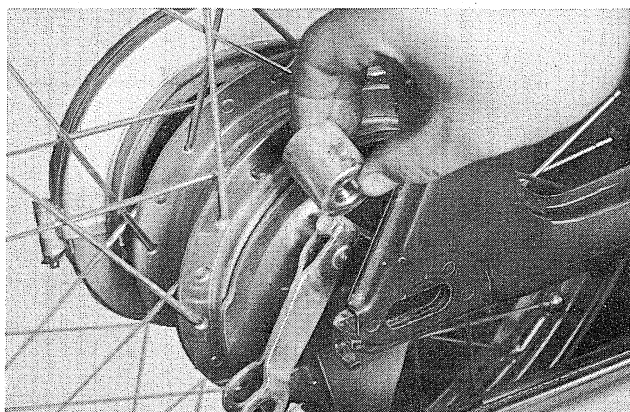

Fig. 4-2-6

- 4) Incline the chassis and remove the rear wheel. (Fig. 4-2-7)

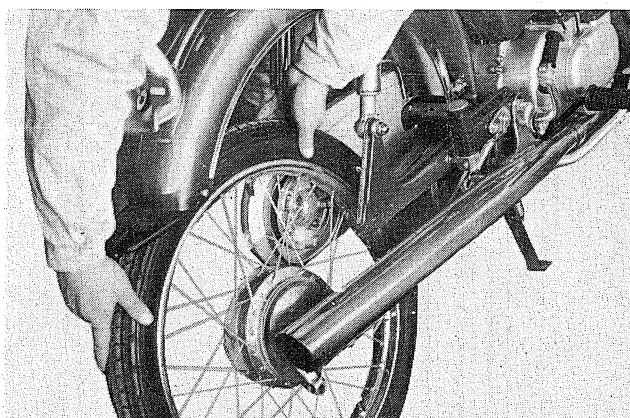

Fig. 4-2-7

- 5) Remove the chain case mounting bolts, and remove the chain. (Figs. 4-2-8 and 9)

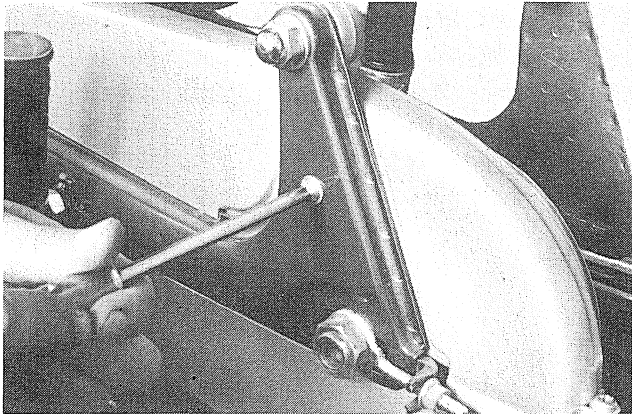

Fig. 4-2-8

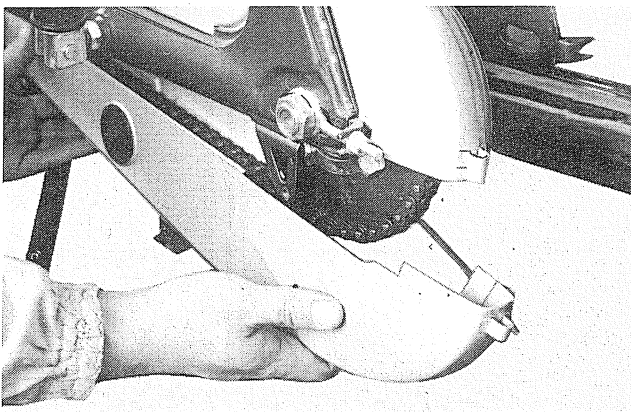

Fig. 4-2-9

- 6) Remove the chain.
- 7) Remove the special hexagon nut and remove the rear clutch ass'y. (Figs. 4-2-10 and 11)

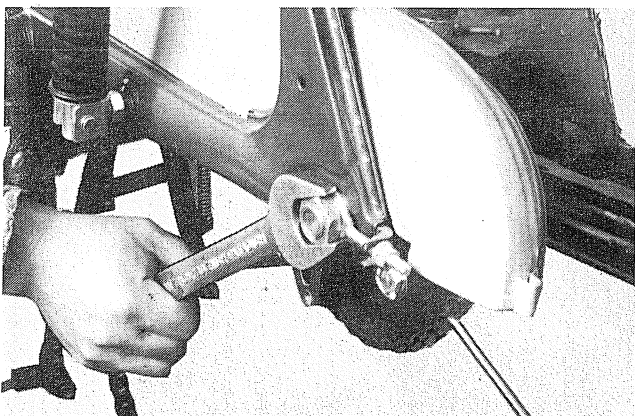

Fig. 4-2-10

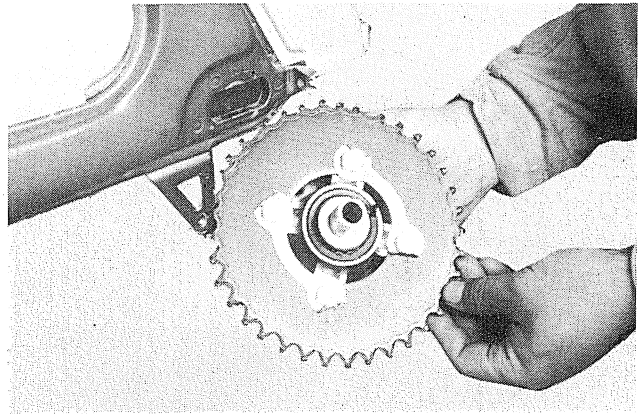

Fig. 4-2-11

C. Checking

- 1) Runout of the Rim
Check the rim for runout in the same manner as the front wheel. Limit of runout . . . 3 mm (0.11") or less.
- 2) Brake Shoe
Check the rear brake shoe in the same manner as the front brake shoe. Limit of size . . . 105 mm (4.14") or less.
- 3) Brake Drum
Check the rear brake drum in the same manner as the front wheel.
- 4) Rear Sprocket
Replace an excessively worn rear sprocket.

4-3 Front Fork

Check the front fork for bend and oil leakage, and correct any defect in the following manner.

- 1) Remove the front fender, and remove the inner tube mounting bolt. (Figs. 4-3-1 and 2)

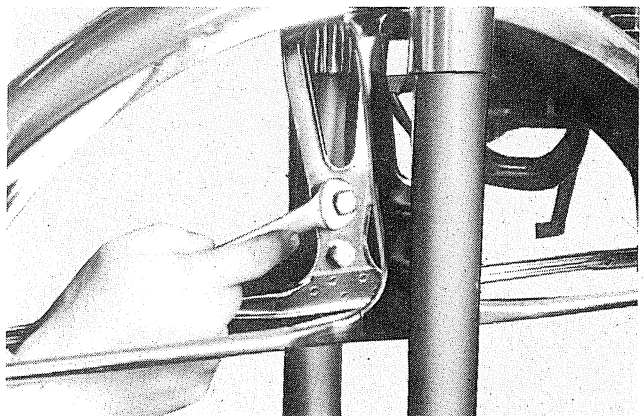

Fig. 4-3-1

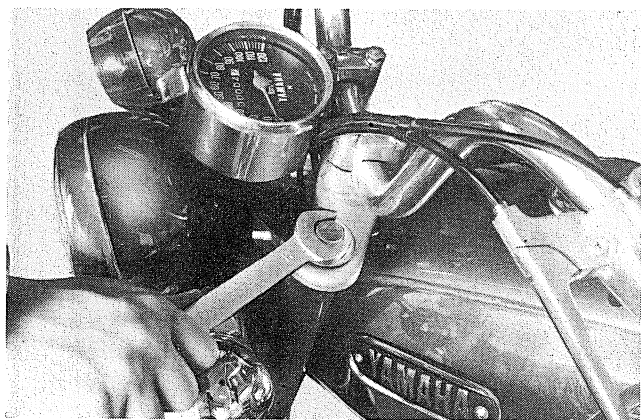

Fig. 4-3-2

- 2) Loosen the inner tube mounting bolt on the lower bracket and pull off the fork downward. (Figs. 4-3-3 and 4)

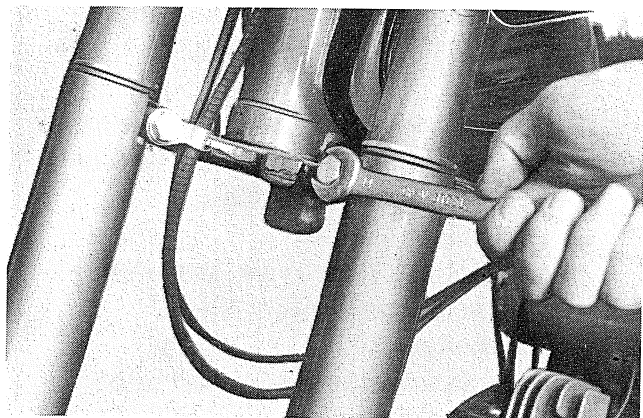

Fig. 4-3-3

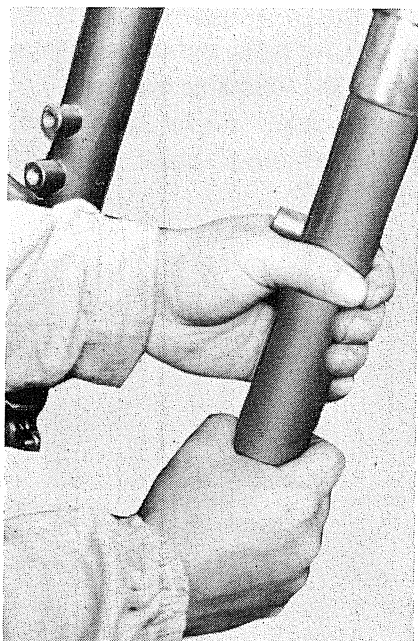

Fig. 4-3-4

B. Disassembling the Fork

- 1) Drain the oil from the fork.
- 2) Place a rubber pad or rubber tube around the outer tube nut.
- 3) Squeeze the outer tube with a strap wrench, and turn it counterclockwise. The inner tube can be separated from the outer.

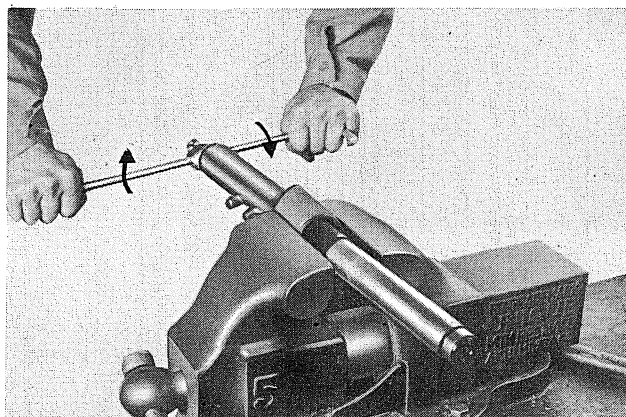

Fig. 4-3-5

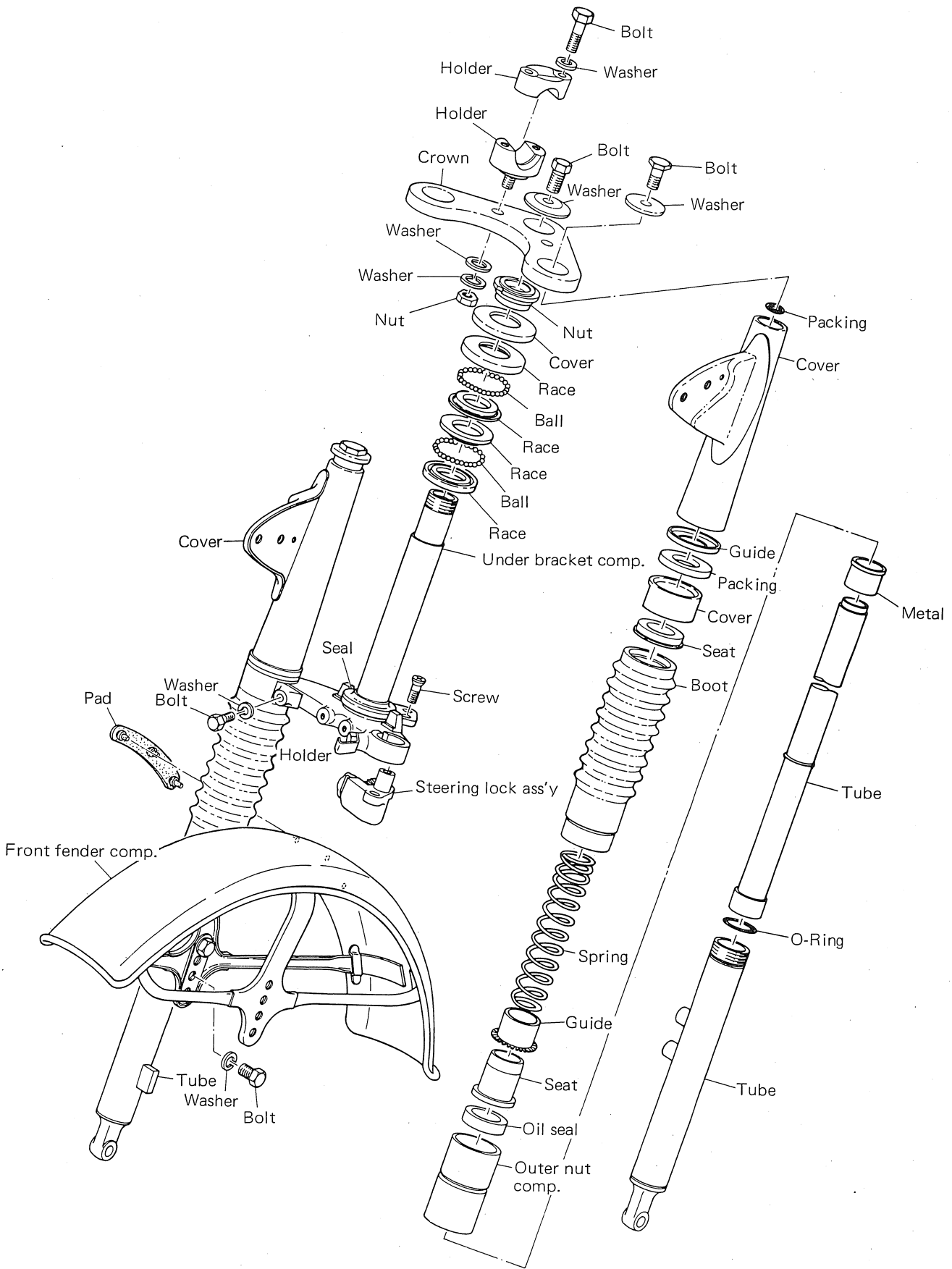

Fig. 4-3-6

CHASSIS - Front Fork

C. Checking

1) Inner Tube

Check the inner tube for bend and scratch.

Slight bends can be corrected by a press machine, but it is the best to replace the tube.

2) Oil Seal

Be sure to replace the oil seals whenever the front fork is disassembled.

D. Reassembling

1) For reassembling the front fork, reverse the order of disassembly as mentioned above. When fitting the outer tube nut in the inner tube, take care not to damage the oil seal fitted in the outer tube.

Grease the tube and cover the inner tube with a nylon cloth before reassembling. Check the inner tube for smooth sliding after reassembling is done. (Figs. 4-3-7 and 8)



Fig. 4-3-7

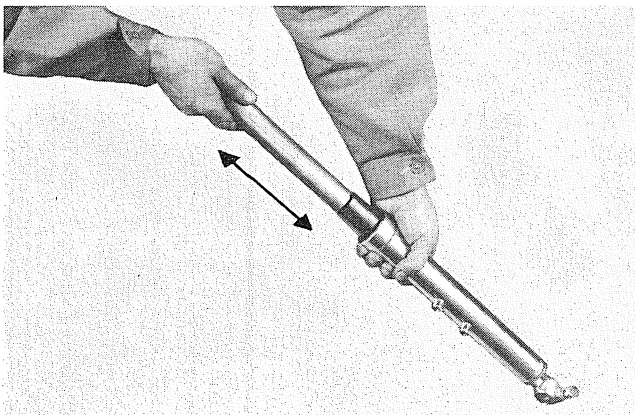

Fig. 4-3-8

2) By using a front fork puller, set the front fork in position, and tighten the lower bracket mounting bolt. (Figs. 4-3-9 and 10)

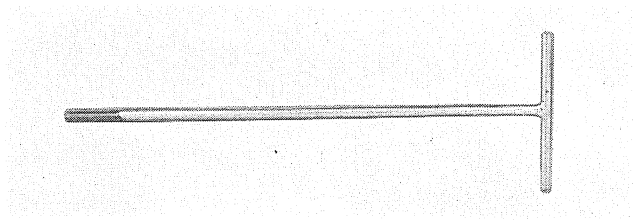

Fig. 4-3-9

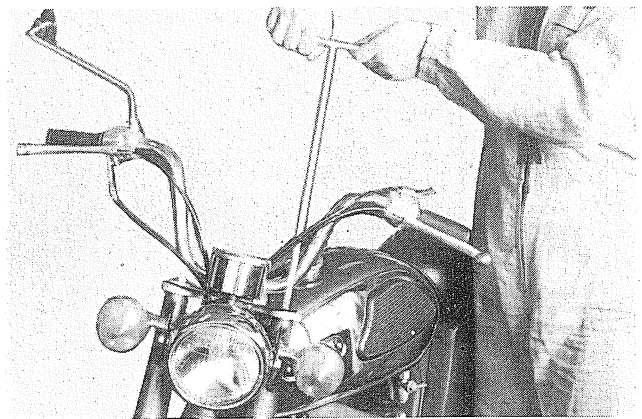

Fig. 4-3-10

- 3) Feed front fork oil into the inner tube through the upper opening. (Fig. 4-3-11)
Oil amount:
Oil amount:
F5/J5, FS1
154 cc (5.2 fl.oz) for right
136 cc (4.6 fl.oz) for left
G5G:
141 cc (4.8 fl.oz) for both right and left
Oil:
Motor oil SAE 10W/30
(or a 80 : 20 mixture of motor oil #30 and spindle oil #60)
- 4) Finally, tighten the inner tube mounting fork.

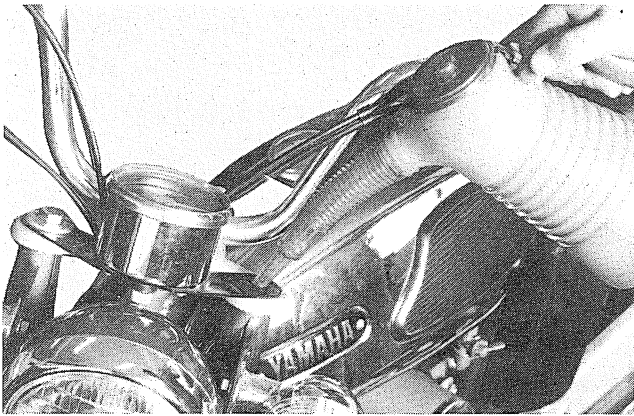

Fig. 4-3-11

4-4 Rear Cushion

The rear cushion can not be disassembled into parts. Therefore, this section will discuss on how to check oil leakage.

A. Checking Oil Leakage

Occasional oil seepage may be seen on the bottom of the outer cover, as viewed from the outside of the rear cushion. This oil seepage may be often mistaken for an oil leakage of the rear cushion.

Such oil seepage mostly results from the melted grease on the inner spring, and will not impair the function of the rear cushion.

For checking oil leakage, the following measure should be taken.

- 1) Remove the rear cushion, and depress it with your hand two or three times. If the spring quickly restores half-way, and gradually stretches for the last 10 mm

(2/5"), the cushion is considered to be in good condition. If the spring restores entirely with quick motion, there may be oil leakage. In this case, replace the whole rear cushion ass'y. (Fig. 4-4-1)

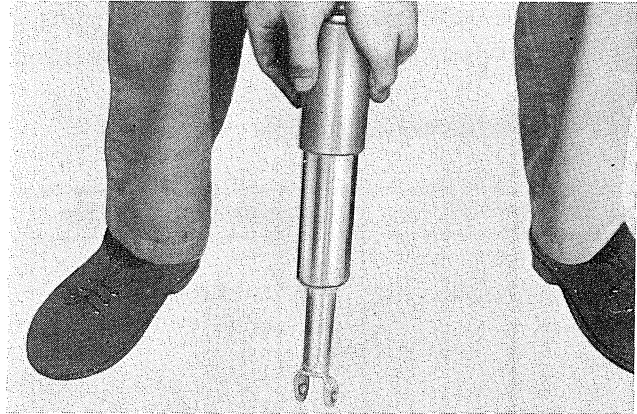

Fig. 4-4-1

4-5 Steering Head

A. Checking

- 1) Ball Races and Steel Balls

Full checking is required for a motorcycle which has been in use for a long time. Balls having uneven wear or cracks will impair the maneuverability. Therefore, if such defects are found, replace the balls and ball races.

Replace any ball having scratches or streaks resulting from wear.

Note:

Do not use a combination of new balls and used races or vice versa. If any of these is found defective, replace the whole ball and race assembly.

CHAPTER 5. ELECTRICAL EQUIPMENT

5-1 Electrical Equipment

All 50F5, 60J5 and 80G5G are provided with electrical parts of 6 volt capacity and a flywheel magneto designed to provide easy access for checking and servicing. The flywheel magneto supplies electricity required for the ignition system, battery and lights. Even at low engine speeds, it provides a sufficient electricity, assuring better spark and greater charging current.

5-2 List of Electrical Components

Name of Part	Name of Manufacturer	Model and Specification
Engine: Flywheel magneto Neutral switch	Mitsubishi Elec. Hitachi Asahi Elec.	FAZ-1QL (for F5/J5, FS1) F11-L40 (for F5/J5, FS1) FCH-1CL (for G5G) Sparking 7 mm or more/500 r.p.m. 8 mm or more/5,000 r.p.m. Charging 0.5A or more/2,500 r.p.m. (for F5/J5, FS1) 0.2A or more/2,000 r.p.m. (for G5G) (battery voltage 6.5V) 4A or less/8,000 r.p.m. (battery voltage 8.5V) Lighting (load 18.5W for F5/J5, FS1 and 19.5W for G5G) 6.3V or more/2,500 r.p.m. (for F5/J5, FS1) 6.8V or more/2,000 r.p.m. (for G5G) (battery voltage 8.5V) 8.7V or less/8,000 r.p.m. (battery voltage 7V) YNS type
Frame: Battery Main switch Silicon rectifier Horn Ignition coil Flasher relay Fuse holder	Furukawa Battery Yuasa Battery G.S Asahi Elec. Fuji Elec. Yuasa Imasen Elec. Nikko Mitsubishi Elec. Showa Elec. Mitsuba Elec.	6N4A-4D CD2-H 1/1 SZ-3A SM3, 6V (for F5/J5, FS1) YP6, 6V (for G5G) HP-B1 B-9 10A, 2 pcs.
Front End: Head light Speedometer	Koito Elec. Nippon Seiki	6V, 15 W/D Neutral light 6V, 3W Meter light 6V, 1.5W
Rear End: Tail light (stop light) Swing Arm: Stop switch	Imasen Elec. Stanley Elec. Asahi Elec.	6V, 3W/10W (for F5/J5) 6V, 3W/10W (for G5G) YS10

5-3 Connection Diagram

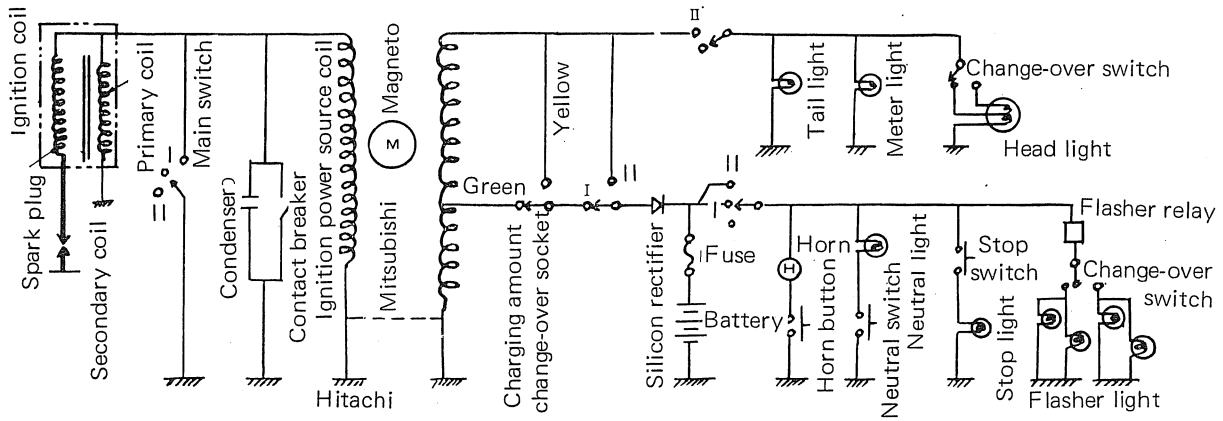

Fig. 5-3-1

5-4 Ignition System-Function and Service

A. Function

The ignition system consists of the components as shown in Fig. 5-4-1. As the flywheel rotates, the contact breaker points begin to open and close, alternately. This make-and-break operation develops an electromotive force in the ignition power source coil, and produces a voltage in the primary coil. The

ignition coil is a kind of transformer, with a 1 : 50 turn ratio of the primary to the secondary winding. The voltage (150 ~ 300V) which is produced in the primary coil, is stepped up to 7,000 ~ 10,000V by mutual-induction, and the electric spark jumps across the spark plug electrodes.

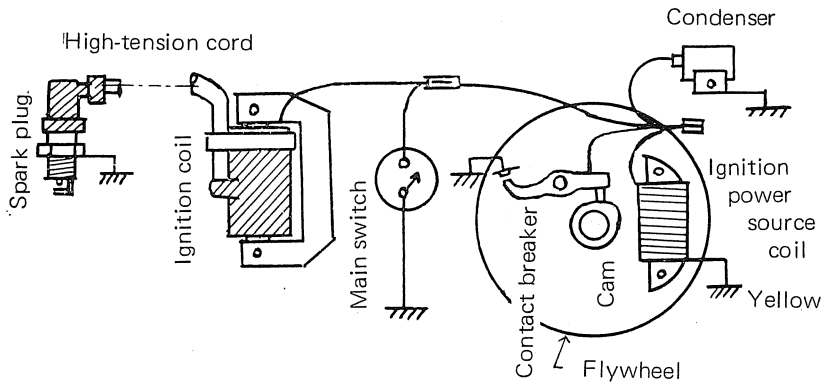
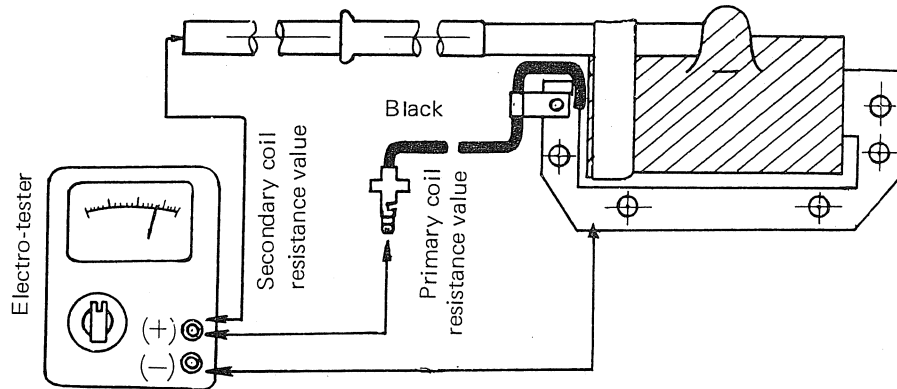

Fig. 5-4-1

B. Service Standards

1) Ignition Timing & Point Gap
 1.8 ± 0.15 mm B.T.D.C. at 0.30 ~ 0.35 mm (0.012").
 Ignition timing can be correctly adjusted by simply setting the maximum point gap to the specified value.
 Smooth away any roughness on the point surface with fine grain sandpaper (#400 ~ #600). Clean greasy points with a rag damped with gasoline.

2) Ignition Coil
 Primary coil resistance value
 $0.6\Omega \pm 10\%$
 Secondary coil resistance value
 $5K\Omega \pm 10\%$
 (For measuring methods, refer to Fig. 5-4-2)



Set the tester on the "Resistance" position.

Fig. 5-4-2

Note:

When measuring the secondary coil resistance value, disconnect the plug cap. Otherwise, the resistance of the 5K Ω

noise suppressor incorporated in the plug will be added to the tester reading.

Sparking:

7 mm or more (between 3 points)
 Remove spark plug from cylinder head and reconnect the high voltage lead.
 Then ground the spark plug and see if it

sparks as you crank the kickstarter.
 If it sparks 7 mm or so and has powder blue, the ignition coil should be considered to be in good condition.

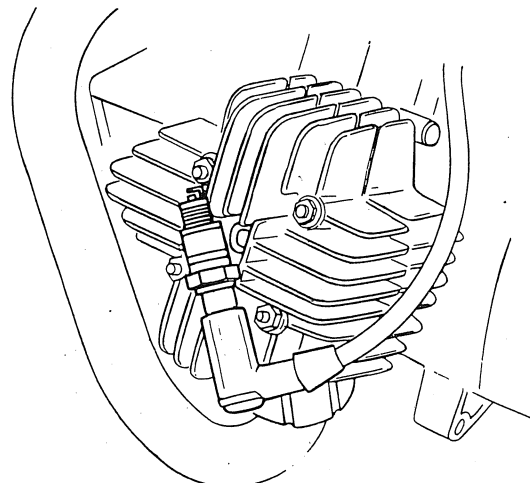

Fig. 5-4-3

3) Condenser

The condenser instantly stores a static electric charge as the contact breaker points separate, and the energy stored in the condenser discharges instantly when the points are closed. If it were not for the condenser, a heavy electric arc would take place across the separating contact points, causing them to burn.

The condenser minimizes the burning of the contact points greatly affecting the flow of current in the primary winding of the ignition coil.

If the contact points show excessive wear or the spark is weak (the ignition coil is in good condition), check the condenser.

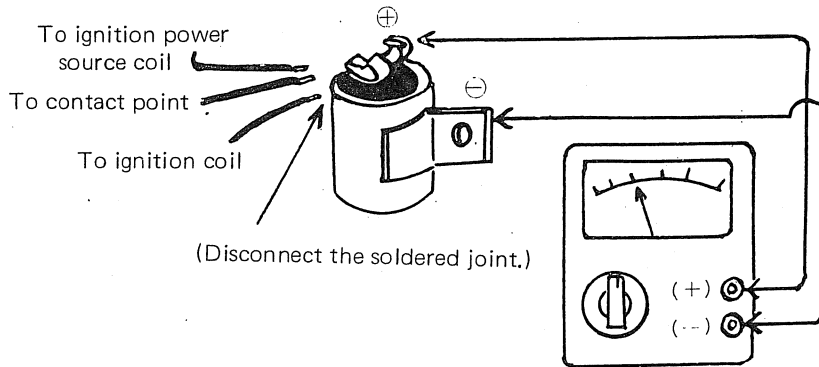

Set the electro-tester on the "MΩ" position.

Fig. 5-4-4

Insulation resistance tests should be conducted by connecting the tester as shown in Fig. 5-4-4. If the pointer swings fully and the reading is more than $3M\Omega$, the insulation is in good condition. If the insulation is punctured, the pointer will stay pointing the uppermost reading.

Note:

After this measurement, the condenser should be discharged by connecting the positive and negative sides with a thick

lead wire.

Capacity tests can be performed by simply setting the tester to the condenser capacity. The tester should be connected with the condenser in the same way as in the case of the insulation resistance test. Before this measurement, be sure to set the tester correctly.

If the reading is within $0.22\mu F \pm 10\%$, the condenser capacity is correct.

5-5 Charging and Lighting Systems-Function and Checking

A. Function of the Charging System

According to the same theory as the ignition coil, an electromotive force of A.C. current is developed in the lighting coil (brown) of the flywheel magneto. As the main switch circuit

is closed, the A.C. current flows to the silicon rectifier, by which the current is rectified into a half-wave current and charged to the battery.

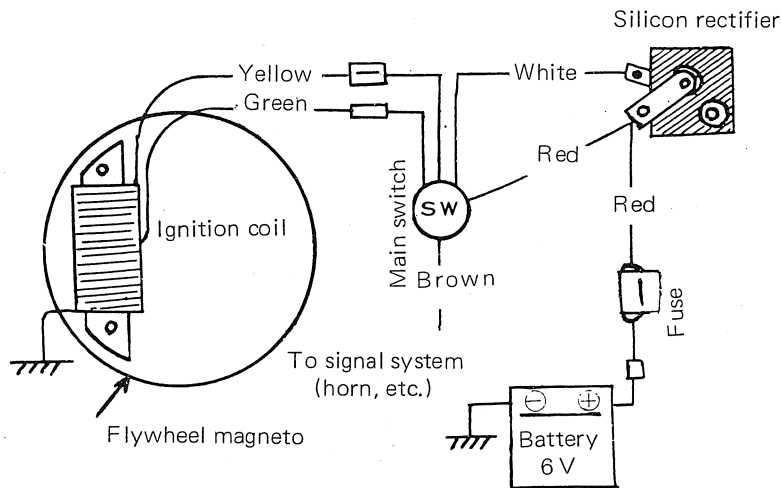

Fig. 5-5-1

B. Checking the Charging System

Motorcycles, which usually travel in urban areas or at low speed, requires such special connection as shown in Fig. 5-5-2 so that the battery can be sufficiently charged even dur-

ing day-time travelling. In this case, the battery should be checked once a month and refilled with electrolyte.

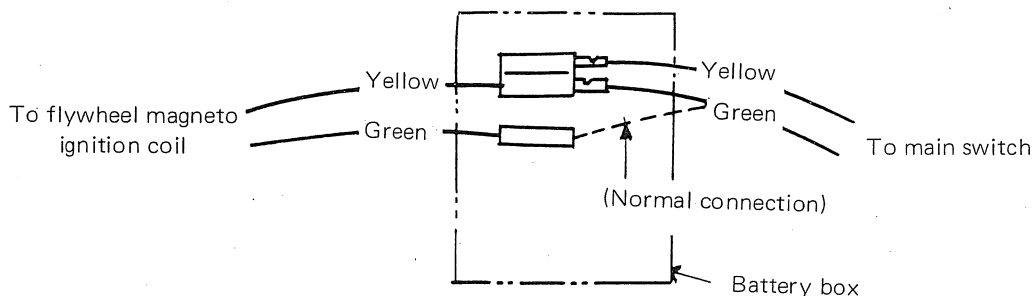

Fig. 5-5-2

1) Measuring the Charging Current

(Use an ammeter with a full scale of 5A)
As shown in Fig. 5-5-3 hook up the tester and measure the current with specific engine r.p.m. The figure in parentheses denotes the battery voltage.

0.5A or more/2,500 r.p.m. (for F5/J5, FS1)

0.2A or more/2,000 r.p.m. (for G5G) (6.5V)

4A or less/8,000 r.p.m. (8.5V)

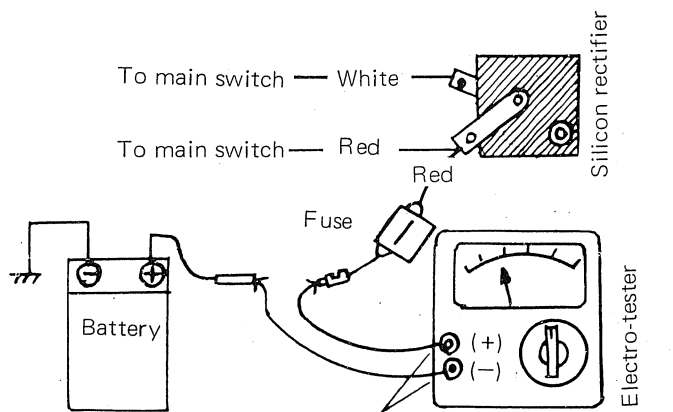

(Connect the leads to 20 A D.C. terminals, and set the tester on "OFF".) (Or D.C. ammeter)

Fig. 5-5-3

Note:

The measurement should be performed under no load, with the main switch set on the "night" position. (The lights including neutral light are not lit up.) If the battery voltage does not agree with the figure in parentheses, the charging current reading will be incorrect. Before the measurement, be sure to measure the voltage of the battery.

2) Checking the Silicon Rectifier

For measurements, an ohmmeter can be used.

However, this section discusses only the checking method by means of the ohmmeter.

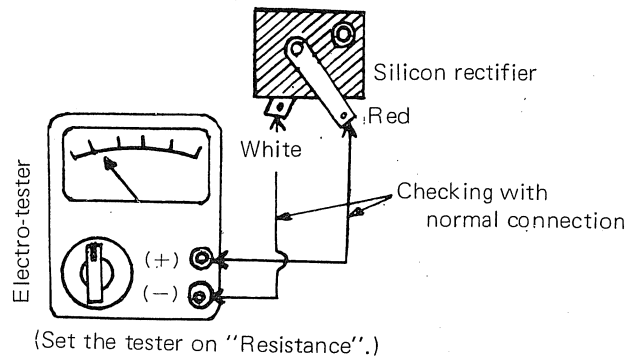

Fig. 5-5-4

Checking with Normal Connection

Connect the tester's red lead (+) to the silicon rectifier's red terminal, and connect the tester's black lead (-) to the rectifier's white terminal.

Standard value: 9 ~ 10Ω

If the tester's pointer will not swing back from the over scale, the rectifier is defective.

Checking with Reversal Connection

Connect the tester the other way round.

Standard value:

If the pointer will not swing, the rectifier is in good condition. If the pointer swings, the rectifier is faulty.

3) Magneto Output Voltage

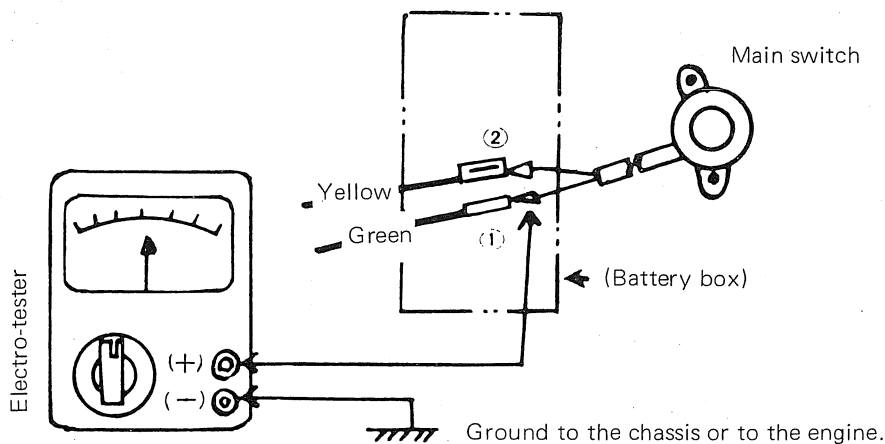

(Set the tester on the "A.C. Voltage" position.)

Fig. 5-5-5

The output voltage for day-time should be measured, with the tester connected in parallel. In Fig. 5-5-5, the tester positive lead is connected to the green lead's connector (the connector is not disconnected). In this measurement, the main switch is on the Day-time position. If the tester reads any voltage, the magneto output voltage is proper.

The output voltage for night-time should be measured, with the tester connected in parallel. In Fig. 5-5-5, the tester positive

lead is connected to the yellow lead. In this measurement, the main switch is on the Night-time position. If the tester reads more than 6 volts at 2,500 r.p.m., the magneto output voltage is sufficient.

- 4) Short-Circuit of Wiring and Switch
Connect the tester as shown in Fig. 5-5-6, and measure the voltage. If the reading is more than 6 volts at 2,500 r.p.m., the wiring and main switch are in good condition.

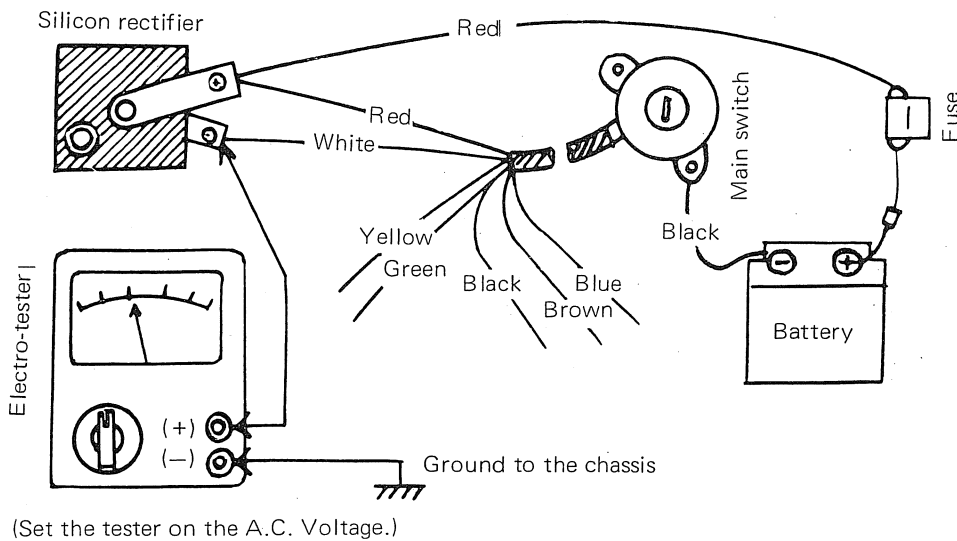
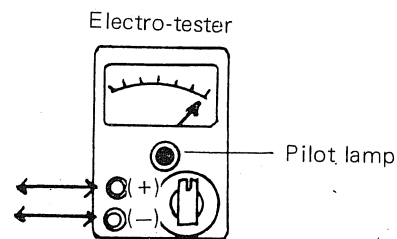
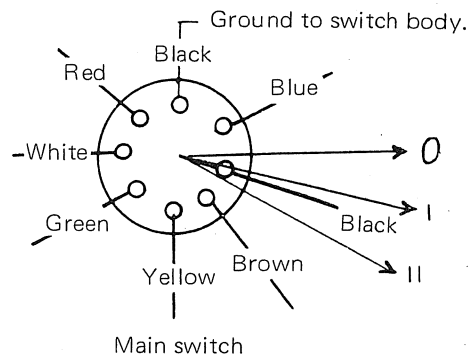

Fig. 5-5-6

5-6 Checking the Main Switch (Removed from the Chassis)

- Key "O" position (Off)
Black ↔ Switch body
- Key "I" position (for day)
Green ↔ White
Red ↔ Brown
- Key "II" position (for night)
Yellow ↔ White
White ↔ Blue
Red ↔ Brown

If the readings or the above six measurements are nearly 0Ω, and no short-circuit is noticed between the terminals, as well as between the lead terminal and the switch body, the main switch is in good condition.



(Switch on the tester and use an ohmmeter.)

Fig. 5-6-1

5-7 Battery

1. Checking

- a. If sulfation occurs on plates due to lack of the battery electrolyte, showing white accumulations, the battery should be replaced.
- b. If the bottoms of the cells are filled with corrosive material falling off plates, the battery should be replaced.
- c. If the battery shows the following defects, it should be replaced.
 - The voltage will not rise to a specific value even after long hours charging.
 - No gassing occurs in any cell.
 - The 6V battery requires a charging current of more than 8.4 volts in order to supply a current at a rate of 1 amp, per hour for 10 hours.

2. Service Life

The service life of a battery is usually 2 to 3 years, but lack of care as described below will

shorten the life of the battery.

- a. Negligence in re-filling the battery with electrolyte.
- b. Battery being left discharged.
- c. Over-charging by rushing charge.
- d. Freezing.
- e. Feeding of water or sulfuric acid containing impurities when re-filling the battery.

3. Storage

If any motorcycle is not used for a long time, remove the battery and have it stored by a battery service shop. The following instructions should be observed by shops equipped with chargers.

- a. Recharge the battery.
- b. Store the battery in a cool, dry place, and avoid temperatures below 0°C (32°F).
- c. Recharge the battery before mounting it on the motorcycle.

4. Service Standards

Battery: 4N4A-4D

Battery Spec.	6V - 4AH	
Electrolyte-Specific gravity and quantity	1.26-1.27, 170cc	At full charge
Initial charging current	0.4A for 25 hours	Brand new motorcycle
Charging current	0.4A for 13 hours (Charge until specific gravity reaches 1.26-1.27)	When discharged
Refilling of electrolyte	Distilled water up to the max. level line.	Once a month

5-8 Spark Plug

The life of a plug and its discoloring vary, according to the habits of the rider. At each periodic inspection, replace burned or fouled plugs with suitable ones according to the color and condition of the bad plugs. One machine may be ridden only in urban areas at low speeds, whereas another may be ridden for hours at high speeds, so confirm what the present plugs indicate by asking the rider how long and how fast he rides, and

recommend a hot, standard, or cold plug accordingly. It is actually economical to install new plugs every 3,000 km (2,000 miles) since it will tend to keep the engine in good condition and prevent excessive fuel consumption.

1. How to "Read" Spark Plug (condition)

- a. Best When the porcelain around the center electrode is a light tan color.

ELECTRICAL EQUIPMENT - Spark Plug

- b. If the electrodes and porcelain are black and somewhat oily, replace the plug with a hotter-type for low speed riding.
- c. If the porcelain is burned white and/or the electrodes are partially burned away, replace the plug with a colder-type for high speed riding.

2. Inspection

Instruct the rider to:

Inspect and clean the spark plug at least once a month or every 1,000 km (500 miles). Clean the electrodes of carbon and adjust the electrode gap to 0.5 ~ 0.6 mm (0.023"). Be sure to use standard plug as replacements to avoid any error in reach.

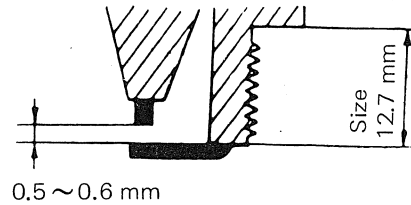

Fig. 5-8-1

Standard spark plug:

	F5/J5	FS1	G5G
Export-Except Specific Area	B-7HS	B-8HCS	B-7HS
Southeast Asia	B-7HS	B-7HS	*BP-7HS
High Lands	B-7HS	B-7HS	B-7HS
Middle & Near East	B-7HS	B-8HCS	B-7HS

* Only Singapore

Chart of wire colors

Engine stop circuit	Black	B
Magnet (for day driving) circuit	Green	Gr
Magnet (for night driving) circuit	Yellow	Y
Battery (+) circuit	Red	R
Earth circuit	Black	B
Stop light circuit	Blue	Bl
Neutral light circuit	Sky Blue	S.Bl
Light circuit	Blue	Bl
Flasher (R) circuit	Dark Green	D.Gr
Flasher (L) circuit	Dark Brown	D.Br
Common circuit	Brown	Br
Head light main circuit	Yellow	Y
Head light sub circuit	Green	Gr
Horn circuit	Pink	P
Silicon circuit (used in	White	W
Selenium rectifier (-) circuit (used in		
Flasher relay circuit	White Brown/White Light White	W Br/W L.W
Ignition coil circuit (R)	Grey	G
Ignition coil circuit (L)	Orange	Or
Tail light circuit	Blue	Bl
Rear brake stop light circuit	Yellow	Y
Armature circuit	White	W
Field circuit	Green	Gr
Front brake stop light circuit	Green/Yellow	Gr/Y
Light switch circuit	Red/Yellow	R/Y
Head/meter light circuit	Blue (L.W)	Bl
Ground circuit	Black	B
Rectifier circuit	White	W
Starting switch circuit	Light Blue, Blue/White (CS2E) only	
Starter circuit	Light Green	L.Gr
AC-G (for night driving) circuit (YL1)	Yellow	Y
AC-G (for day driving) circuit (YL1)	White	W
AC-G silicon circuit (YL1)	Green	Gr
Stop lamp circuit, head light-up (YL1, YL1-E)	Blue	Bl
Daytime charging circuit (CT1, RT1)	Green	Gr
Nighttime charging circuit (CT1, RT1)	Green/Red	Gr/R

F5/J5

Note If you often drive at slow speed or use the stop light and flasher light frequently, the battery will discharge the following slight change in the circuit will allow better charging.
Connect the green lead wire of the main switch to the terminal of the yellow as illustrated in the circuit diagram with a dotted line.

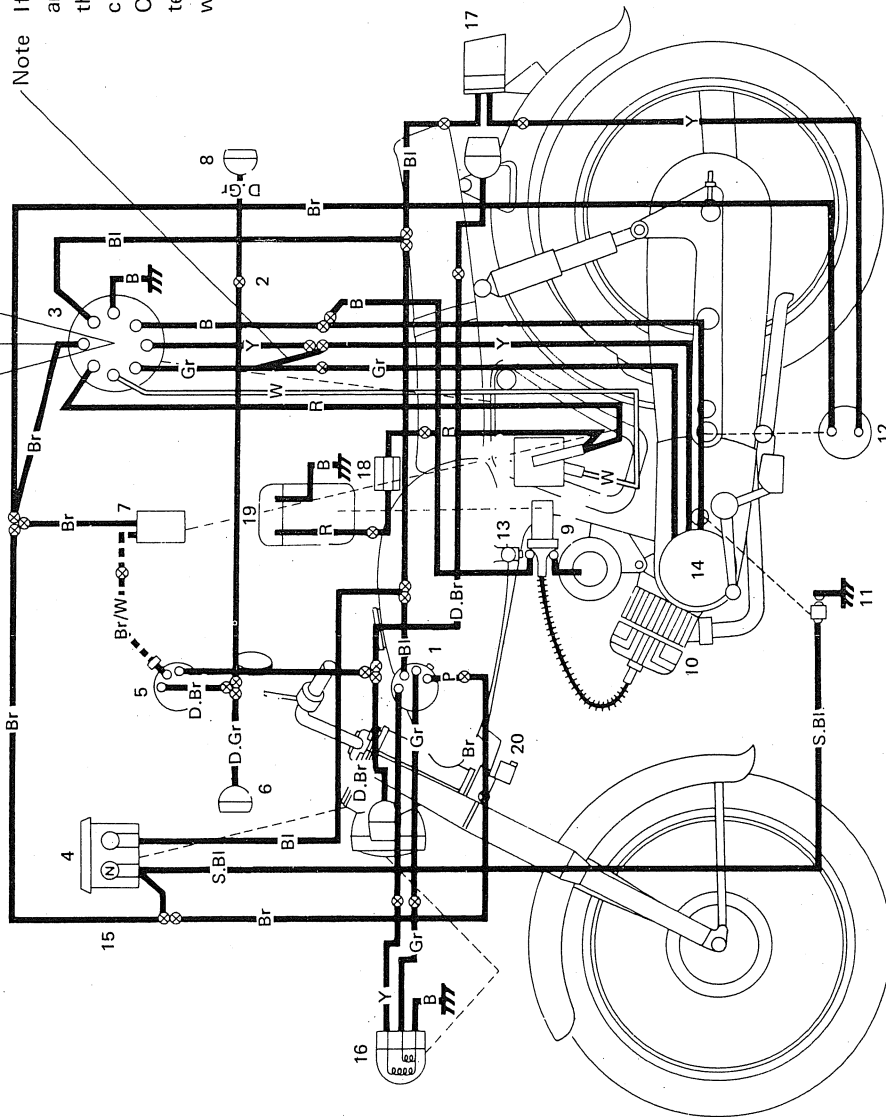

- 1. Horn switch
- 2. Sub switch
- 3. Main switch
- 4. Speedometer
- 5. Flasher switch
- 6. Front flasher light
- 7. Flasher relay
- 8. Rear flasher light
- 9. Ignition coil
- 10. Spark plug
- 11. Neutral switch
- 12. Stop switch
- 13. Silicone rectifier
- 14. Flywheel magneto
- 15. Meter light 6V 1.5W
Neutral pilot light 6V 3W
- 16. Head light 6V 15W D
- 17. Tail lamp 6V 3W
- 18. Stop lamp 6V 10W
- 18. Fuse 10A
- 19. Battery 6V 4AH
- 20. Horn

Circuit connected by main switch

Position	Color	black-earth	green-white	yellow-white	yellow-blue	red-brown
0		o	x	x	x	x
I		x	o	x	x	o
II		x	x	o	o	o

G5G

Circuit connected by main switch

Color Position	black- earth	green- white	yellow- white	yellow- blue	red- brown
0	o	x	x	x	x
I	x	o	x	x	o
II	x	x	o	o	o

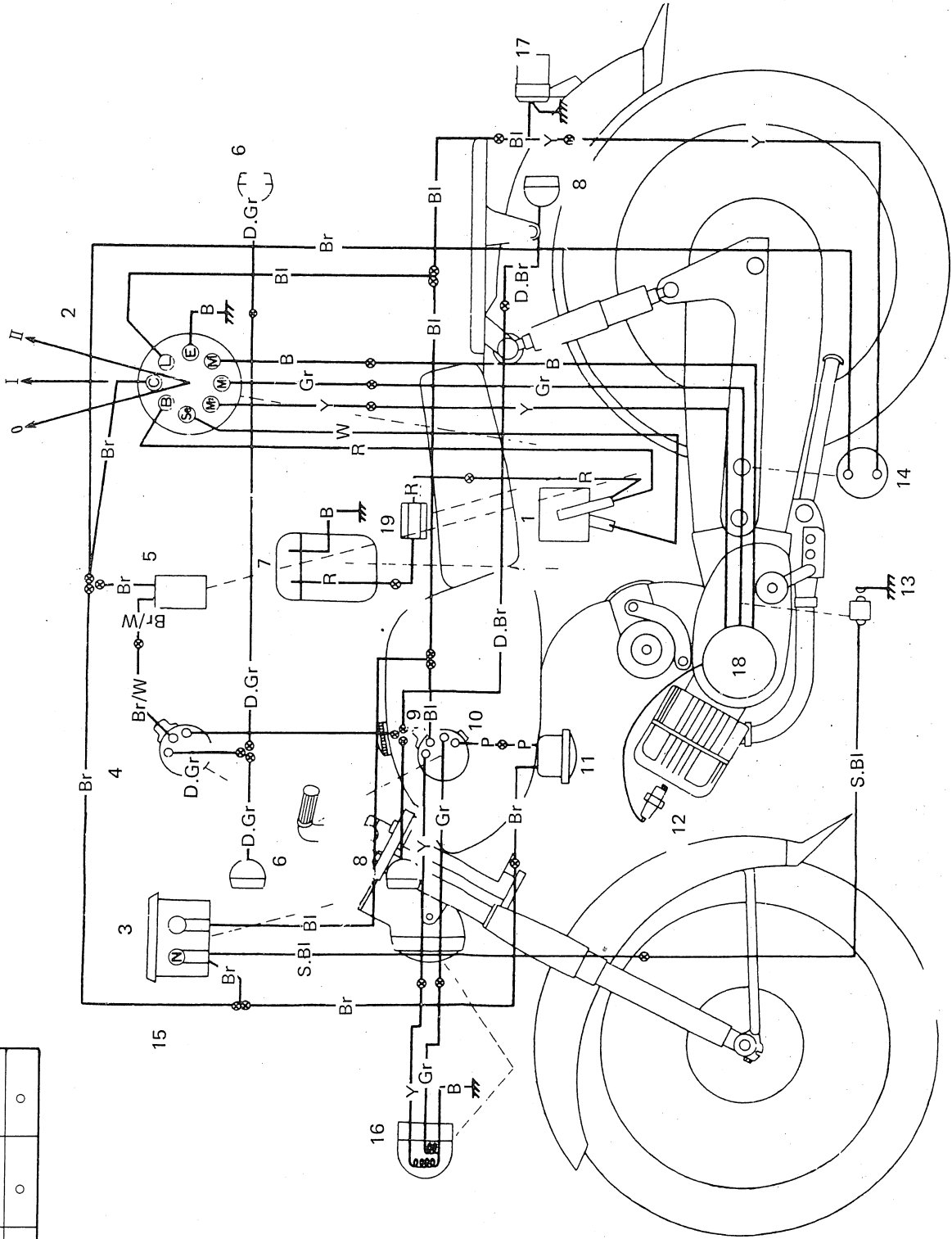

1. Selenium rectifier
2. Main switch
3. Speedometer
4. Flasher switch
5. Flasher relay
6. Flasher lamp (R) 6V 8W x 2
7. Battery 6V 4AH
8. Flasher lamp (L)
9. Flasher lamp switch
10. Horn button
11. Horn
12. Spark plug
13. Neutral switch
14. Stop switch
15. Meter lamp 6V 1.5W
16. Head light 6V 15W D
17. Tail lamp 6V 3W
18. Stop lamp 6V 10W
19. Flywheel magneto
19. Fuse 10A

FS1

Note: If you often drive at slow speed or use the stop light and flasher light frequently, the battery will discharge, the following slight change in the circuit will allow better charging.
Connect the green lead wire of the main switch to the terminal of the yellow as illustrated in the circuit diagram with a dotted line.

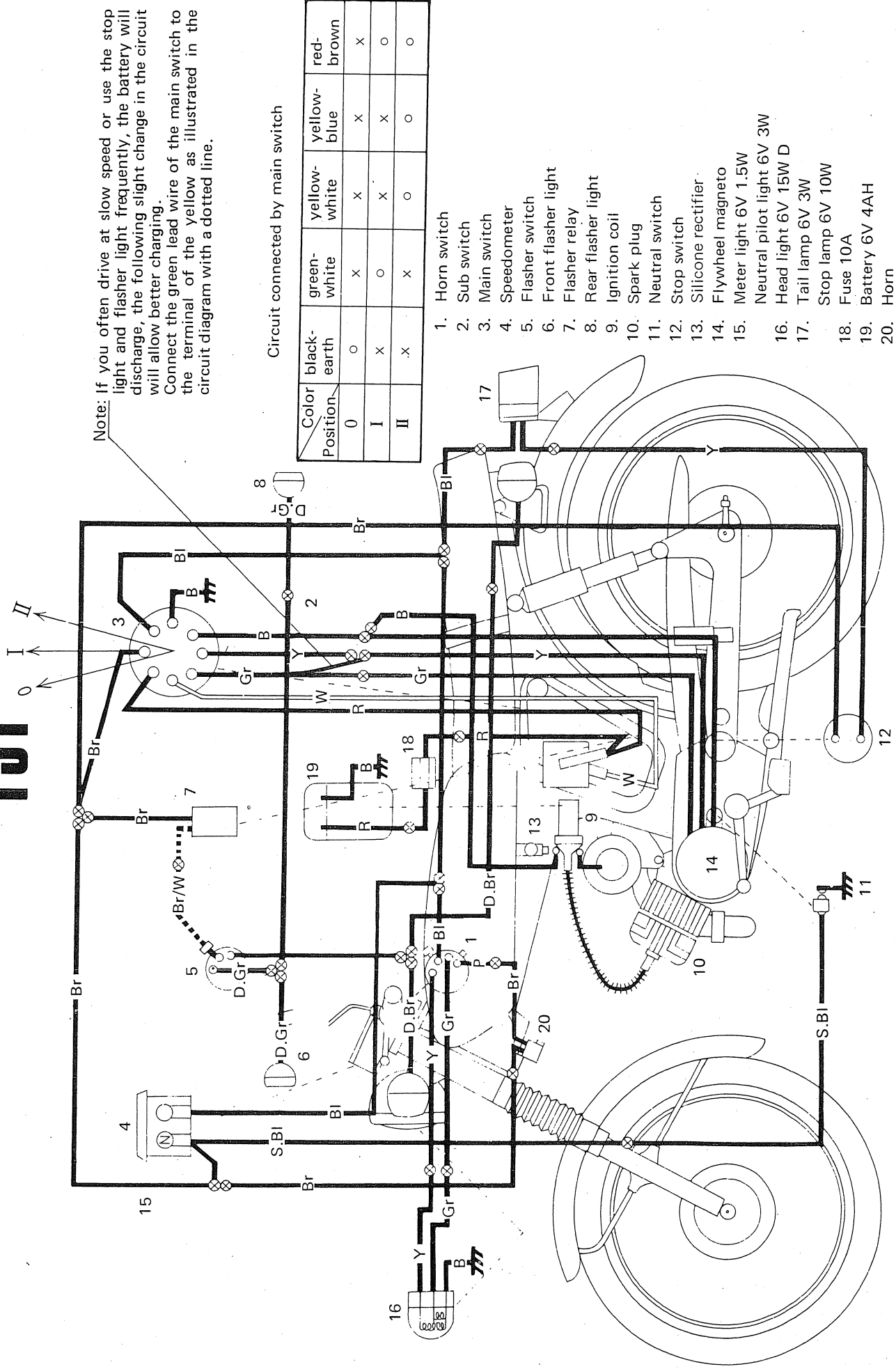

Circuit connected by main switch

Color Position	black-earth	green-white	yellow-white	yellow-blue	red-brown
0	o	x	x	x	x
I	x	o	x	x	o
II	x	x	o	o	o

1. Horn switch
2. Sub switch
3. Main switch
4. Speedometer
5. Flasher switch
6. Front flasher light
7. Flasher relay
8. Rear flasher light
9. Ignition coil
10. Spark plug
11. Neutral switch
12. Stop switch
13. Silicone rectifier
14. Flywheel magneto
15. Meter light 6V 1.5W
16. Neutral pilot light 6V 3W
17. Head light 6V 15W D
18. Tail lamp 6V 3W
19. Stop lamp 6V 10W
20. Fuse 10A
21. Battery 6V 4AH
22. Horn

CONVERSION TABLE

LENGTHS

Multiply	By	To Obtain	Multiply	By	To Obtain
Millimeters (mm)	0.03937	Inches	Kilometers (km)	.6214	Miles
Inches (in)	25.4	Millimeters	Miles (mi)	1.609	Kilometers
Centimeters (cm)	.3937	Inches	Meters (m)	3.281	Feet
Inches (in)	2.54	Centimeters	Feet (ft)	.3048	Meters

WEIGHTS

Kilograms (kg)	2.205	Pounds	Grams (g)	.03527	Ounces
Pounds (lbs)	.4536	Kilograms	Ounces (oz)	28.25	Grams

VOLUMES

Cubic centimeters (cc)	.06102	Cubic inches	Imperial gallons	277.274	cu.in.
Cubic inches (cu.in.)	16.387	cc.	Liters (ℓ)	1.057	Quarts
Liters (ℓ)	.264	Gallons	Quarts (qt)	.946	Liters
Gallons (gal)	3.785	Liters	Cubic centimeters (cc)	.0339	Fluid ounces
U.S. gallons	1.2	Imperial gals.	Fluid ounces (fl. oz)	29.57	cc.
Imperial gallons	4.537	Liters			

OTHERS

Metric horsepower (ps)	1.014	bhp	Foot-pounds (ft-lbs)	.1383	kg-m
Brake horsepower (bph)	.9859	ps.	Kilometers per liter (km/ℓ)	.2352	mpg
Kilogram-meter (kg-m)	7.234	Foot-pounds	Miles per gallon (mpg)	.4252	km/ℓ
Kilograms/sq.cm (kg/cm ²)	14.22	Pounds/sq.in. (lbs/in ² or psi)			
Centigrade (C°)	(C° × 9/5) + 32	Fahrenheit (F°)			

TORQUE SPECIFICATIONS

Stud size	kg-m	In-lbs *
6mm	1.0	90
7	1.5	135
8	2.0	180
10	3.2-4.0	300-350
12	4.0-4.6	350-400
14	4.6-5.2	400-450
17	5.87-7.0	500-600

* Ft-lbs = In-lbs divided by 12

Millimeters to Inches

	0	.1	0.2	0.3	0.4	0.5	0.6	0.7	0.8	0.9
0		.0039	.0079	.0118	.0157	.0197	.0236	.0276	.0315	.0354
1	.0394	.0433	.0472	.0512	.0551	.0591	.0630	.0669	.0709	.0748
2	.0787	.0827	.0666	.0906	.0945	.0984	.1024	.1063	.1102	.1142
3	.1181	.1200	.1260	.1299	.1339	.1378	.1417	.1457	.1496	.1535
4	.1575	.1614	.1654	.1693	.1732	.1772	.1811	.1850	.1890	.1929
5	.1969	.2000	.2047	.2087	.2126	.2165	.2205	.2244	.2283	.2323
6	.2362	.2402	.2441	.2480	.2520	.2559	.2598	.2638	.2677	.2717
7	.2756	.2795	.2835	.2874	.2913	.2953	.2992	.3031	.3071	.3110
8	.3150	.3189	.3228	.3268	.3307	.3346	.3386	.3425	.3465	.3504
9	.3543	.3583	.3622	.3661	.3701	.3740	.3780	.3819	.3858	.3898
10	.3937	.3976	.4016	.4055	.4094	.4134	.4173	.4213	.4252	.4291

.01mm = .0004" .03mm = .0012" .05mm = .0020" .07mm = .0028" .09mm = .0035"
 .02mm = .0008" .04mm = .0016" .06mm = .0024" .08mm = .0031" .10mm = .0039"

Inches to Millimeters

	0	.01	.02	.03	.04	.05	.06	.07	.08	.09
0		.254	.508	.762	1.016	1.270	1.524	1.778	2.032	2.286
.1	2.540	2.794	3.048	3.302	3.556	3.810	4.064	4.318	4.572	4.826
.2	5.080	5.334	5.588	5.842	6.096	6.350	6.604	6.858	7.112	7.366
.3	7.620	7.874	8.128	8.382	8.636	8.890	9.144	9.398	9.652	9.906
.4	10.160	10.414	10.668	10.922	11.176	11.430	11.684	11.938	12.192	12.446
.5	12.700	12.954	13.208	13.462	13.716	13.970	14.224	14.478	14.732	14.986
.6	15.240	15.494	15.748	16.002	16.256	16.510	16.764	17.018	17.272	17.526
.7	17.780	18.034	18.288	18.542	18.796	19.050	19.304	19.558	19.812	20.066
.8	20.320	20.574	20.828	21.082	21.336	21.590	21.844	22.098	22.352	22.606
.9	22.860	23.114	23.368	23.622	23.876	24.130	24.384	24.638	24.892	25.146
1.0	25.400	25.654	25.908	26.162	26.416	26.670	26.924	27.178	27.432	27.686

.001" = .0254mm .003" = .0762mm .005" = .1270mm .007" = .1778mm .009" = .2286mm
 .002" = .0508mm .004" = .1016mm .006" = .1524mm .008" = .2032mm .010" = .254mm

YAMAHA
Supplementary Service Information
for New Model
MODEL 50 FS1

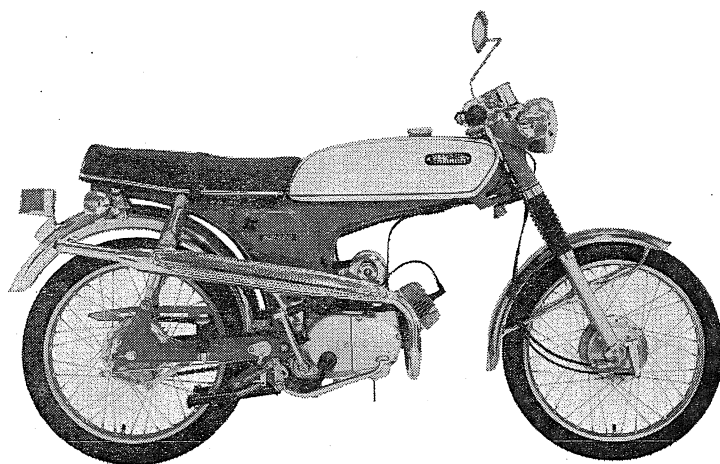

YAMAHA MOTOR CO., LTD.

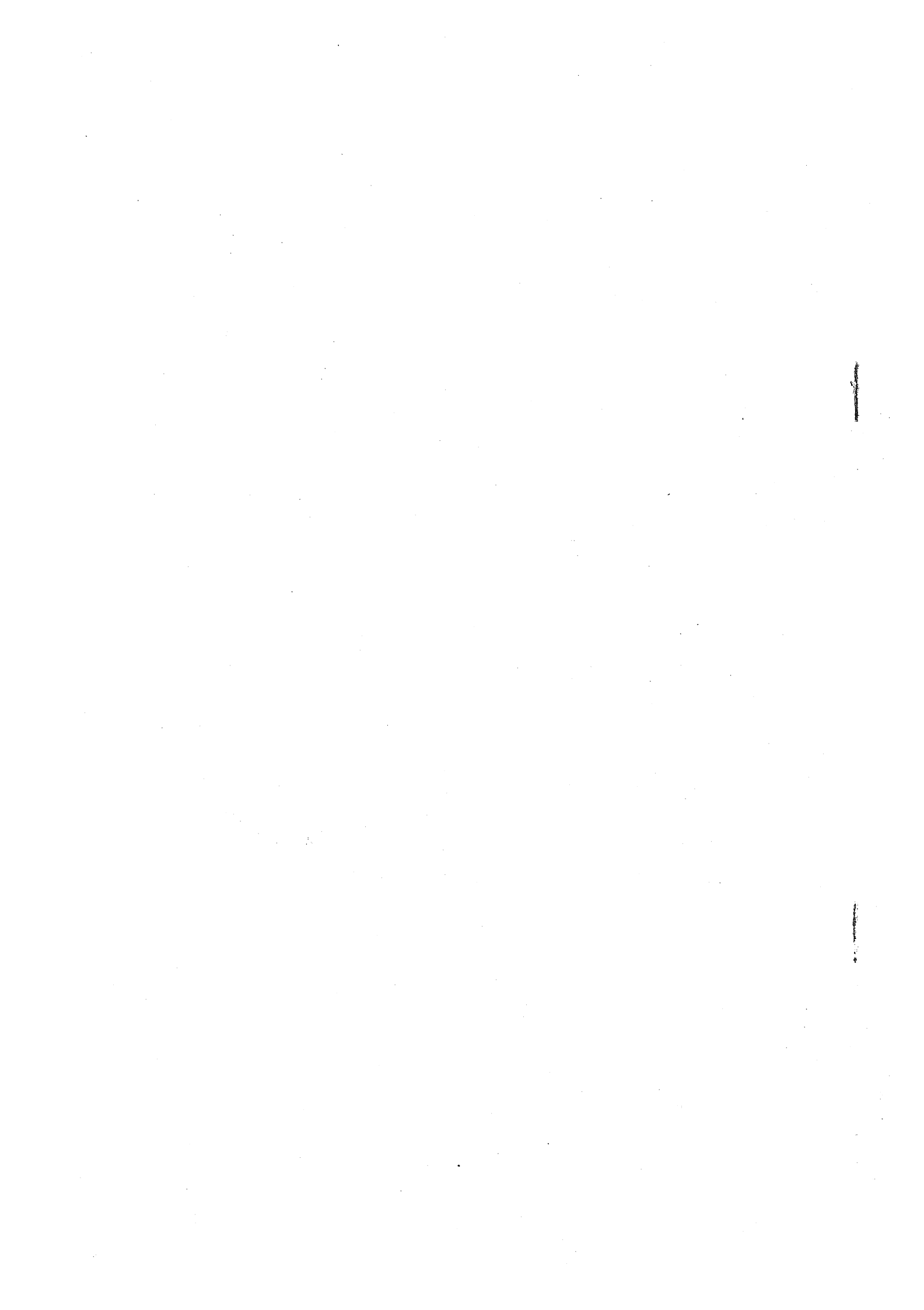

FOREWORD

Yamaha has released a new 50 cc FS1, which is a long-awaited sportster equipped with a 5-speed transmission.

Despite its small-sized engine, the FS1 is superior in high speed performance. In addition, it has numerous features in appearance, such as stream lined fuel tank, separate speedometer, compactly-built engine and increased number of chrome-plated parts.

On the other hand, design emphasis is laid on smooth and safe riding on the streets.

This Supplementary Service Information contains the most essential technical data required for your service and sales activities.

The FS1 is common in many parts with its predecessors F5S and F5C. For details, refer to the Service Manual of the F5 and J5.

YAMAHA MOTOR CO., LTD.

Service Division

I. FEATURES

1. Rotary Valve Engine with 5-speed Transmission

Equipped with a proven compact rotary valve engine and 5-speed transmission, this new Yamaha fifty FS1 gives for greater power more than the 50cc machine. It is superbly agile, with quick acceleration and steady performance.

2. Reliable Yamaha Autolube

Like every other Yamaha model, the Yamaha FS1 also employs the world-renowned Autolube. It automatically meters oil to the engine on demand, depending on speed and load.

Thus, lubrication is extremely thorough and economical.

3. Starter-jet Built-in Carburetor

The starter-jet equipped carburetor makes starting easy even in the coldest season.

4. Convenient Primary Kick Starter

The primary kick starter enables the engine to be started with the transmission in any position.

This is a welcome convenience to the rider in heavy traffic.

5. Stable Braking

Waterproof, dustproof brake drums employed for both front and rear wheels provide stable, fade-free braking on wet or dusty roads.

6. Unique Design

The stream lined design, including the fuel tank, compact engine, and separate speedometer, brings a new racer "image" to the street. Adding to a touch of extravagant luxury are the chrome-plated flasher lights, front and rear fenders, and buffed front and rear hubs.

7. Safety Equipment

For the sake of the rider's safety, larger-sized headlight and flasher lights are employed, along with ball-joint back mirror. Another improvement is a symmetrical double-edged key which is designed to serve a main and steering lock key.

I SPECIFICATIONS AND PERFORMANCE

The following data subject to change without notice.

MODEL	50 FS1
Dimensions:	
Overall length	1,755 mm (69.1 in.)
Overall width	555 mm (21.9 in.)
Overall height	935 mm (36.8 in.)
Wheelbase	1,160 mm (45.7 in.)
Ground clearance	135 mm (5.3 in.)
Weight:	
Net	70 kg (154 lbs.)
Gross	77 kg (170 lbs.)
Performance:	
Max. speed	95 km/h (59 mph)
Fuel consumption	80 km/liter at 30 km/h (188 mpg at 19 mph)
Climbing ability	18 degrees
Minimum turning radius	1,800 mm (70.9 in.)
Braking distance	7 m at 35 km/h (23.0 ft. at 22 mph)
Acceleration performance (0-200 m)	13.15 sec.
Engine:	
Type	2-stroke, air cooled, forward inclined.
Cylinder	Single
Displacement	49 cc (2.99 cu. in.)
Bore × Stroke	40 × 39.7 mm (1.575 × 1.563 in.)
Compression ratio	6.8 : 1
Max. output	6 HP/9,000 rpm
Max. torque	0.5 kg-m/8,000 rpm (3.6 ft-lbs/8,000 rpm)
Starting system	Kick starter
Ignition system	Flywheel magneto
Carburetor:	VM16SC × 1
Air Cleaner:	Dry, paper filter
Transmission:	
Clutch	Wet, multi-disc
Primary reduction system	Helical gear
Primary reduction ratio	3.895 (74/19)

Gear box:	
Type	Constant mesh, 5-speed forward
Reduction ratio 1st	3.417 (41/12), Total reduction ratio-37.070
Reduction ratio 2nd	2.059 (35/17), Total reduction ratio-22.337
Reduction ratio 3rd	1.476 (31/21), Total reduction ratio-16.016
Reduction ratio 4th	1.167 (28/24), Total reduction ratio-12.658
Reduction ratio 5th	1.000 (26/26), Total reduction ratio-10.850
Secondary reduction system	Chain
Secondary reduction ratio	2.786 (39/14)
Chassis:	
Type of frame	Pressed steel back bone
Suspension system, front	Telescopic
Suspension system, rear	Swing arm
Cushion system, front	Coil spring, oil damper
Cushion system, rear	Coil spring, oil damper
Steering system:	
Steering angle	45 degrees both right and left
Caster	68.5 degrees
Trail	75.6 mm (3.0 in.)
Braking system:	
Type	Internal expansion
Operation method, front	Right hand operation, cable actuated
Operation method, rear	Right foot operation, rod actuated
Tire:	
Tire, front	2.25-17-4PR
Tire, rear	2.50-17-4PR
Tank:	
Fuel tank capacity	6.0 liters (1.6 US gals.)
Oil tank capacity	1.4 liters (1.5 US qts.)
Generator:	
Model	FAZ-IQL
Manufacturer	Mitsubishi Elec., Hitachi
Spark plug:	B-8HC
Battery:	
Model	BST2-6
Capacity	6V 4AH
Lights:	
Headlight	6V 15W/15W
Taillight	6V 3W
Stop light	6V 10W
Flasher light	6V 8W×4
Meter light	6V 1.5W
Neutral pilot light	6V 3W

III EXTERNAL VIEW

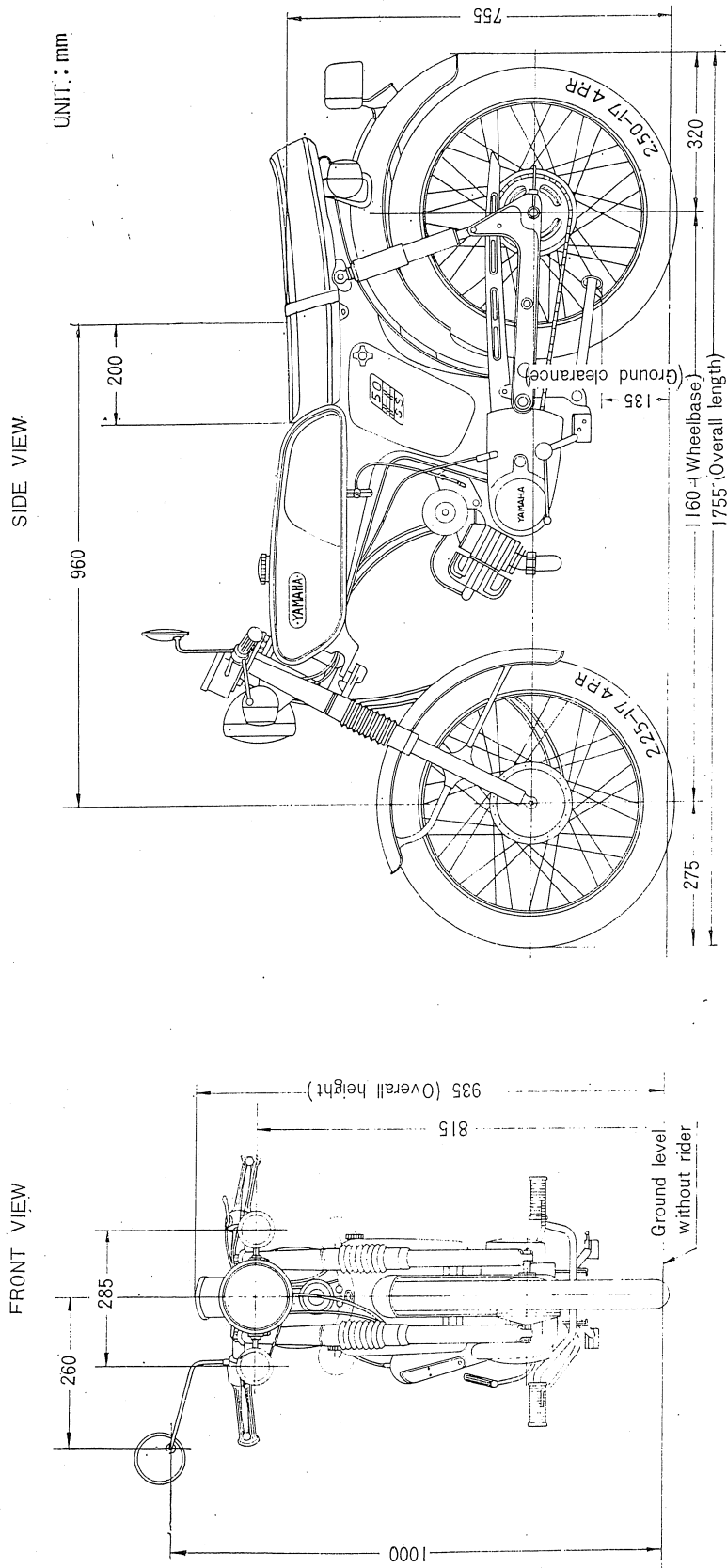

IV PERFORMANCE CURVES

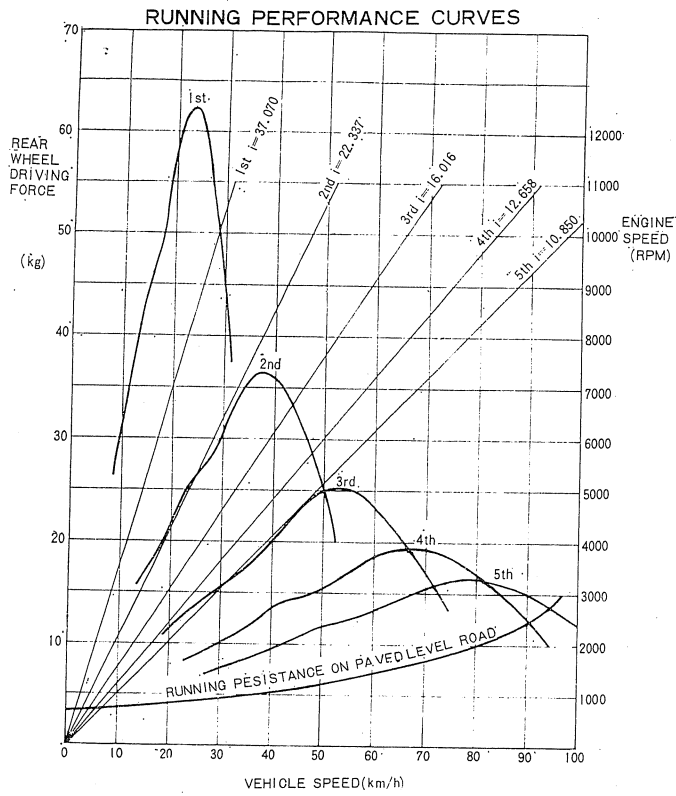
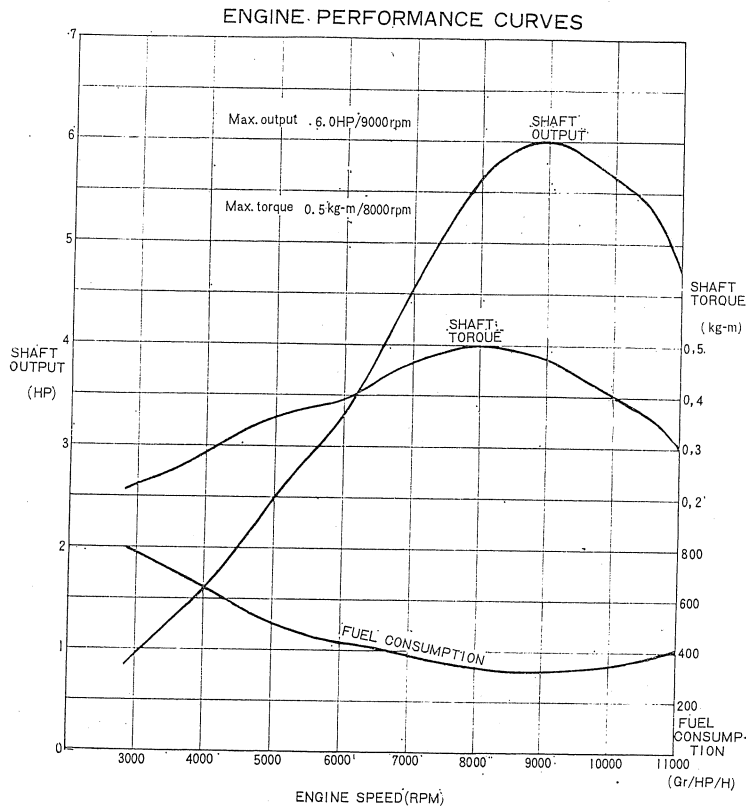

V PRINCIPAL MODIFICATIONS

V-1. ENGINE

Parts of new design are used at places in the engine to boost its output. To make it easy to handle the engine, the weight is reduced to as light as 18 kg (39.7 lbs.) (F5S-22kg (48.8 lbs.)), while the width to 245 mm (9.65 in.) (F5S-297 mm (11.7 in.))

1. Cylinder & Piston

1) Cylinder Head

The volume of the combustion chamber is changed as follows:

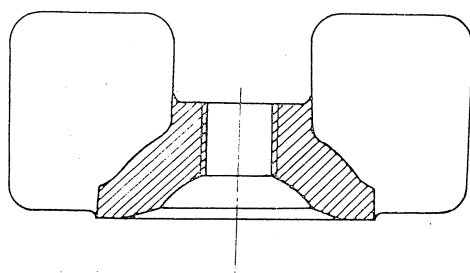

Fig. 5-1-1

Volume of combustion chamber
with spark plug mounted
F5S.....6.0 cc
FS1.....5.4 cc

2) Cylinder

The port timing is improved to meet requirements of high speed performance, as compared with the F5S.

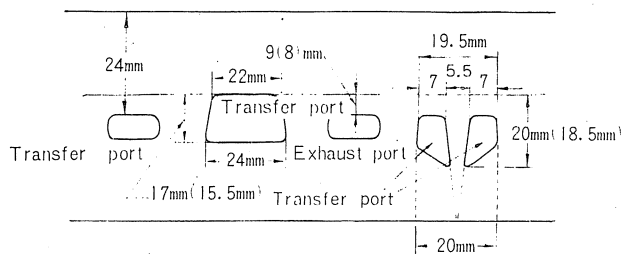

Fig. 5-1-2

The figure in parentheses denotes the port timing of the F5S.

3) Valve

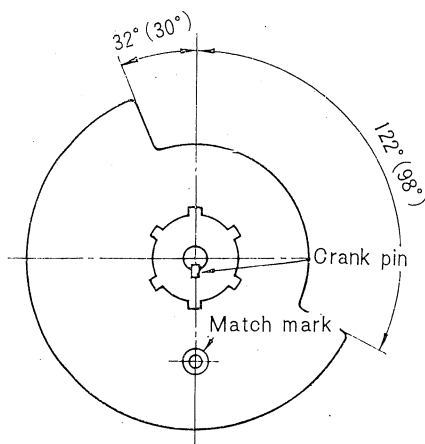

Fig. 5-1-3

The figure in parentheses denotes the port timing of the F5S. The strengthening ring, which was used in the valve where the crankshaft is inserted, is no longer in use. Only bakelite is used.

Note on assembling:

Align the match mark of the valve with the locating pin on the crankshaft as shown in the figure to the left.

4) Piston and Piston Rings

Specially designed for many hours of continuous high speed riding, both piston and rings are of the Keystone type, featuring less carbon build-up.

2. Air Cleaner

The air cleaner is of a cylindrical type, which has already become familiar to Yamaha fans. Except for the length, it is exactly the same as that of the F5S. Length is shorter 15 mm to match the shape of the muffler, and as a result, the air cleaner is not interchangeable with that of the F5S.

3. Crankcase (left) and Crankcase Cover (left)

To make the engine assembly compact, both crankcase (left) and crankcase cover (left) are exclusive parts for the FS1.

4. Muffler and Protector

Because of the narrower width of the engine, the muffler assembly (exhaust pipe is made in one piece assembly with the muffler) differs in profile from those of the F5C and the F5S.

The protector is also new in design.

Both silencer and muffler stay are similar in type to that of the F5C.

5. Kick Starter

The kick starter is designed to engage with the gear only when the kick pedal is kicked, as in the case of the F5S and F5C, and therefore, parts are interchangeable with those for these two models.

The kick crank is the same in type as that of the YL1.

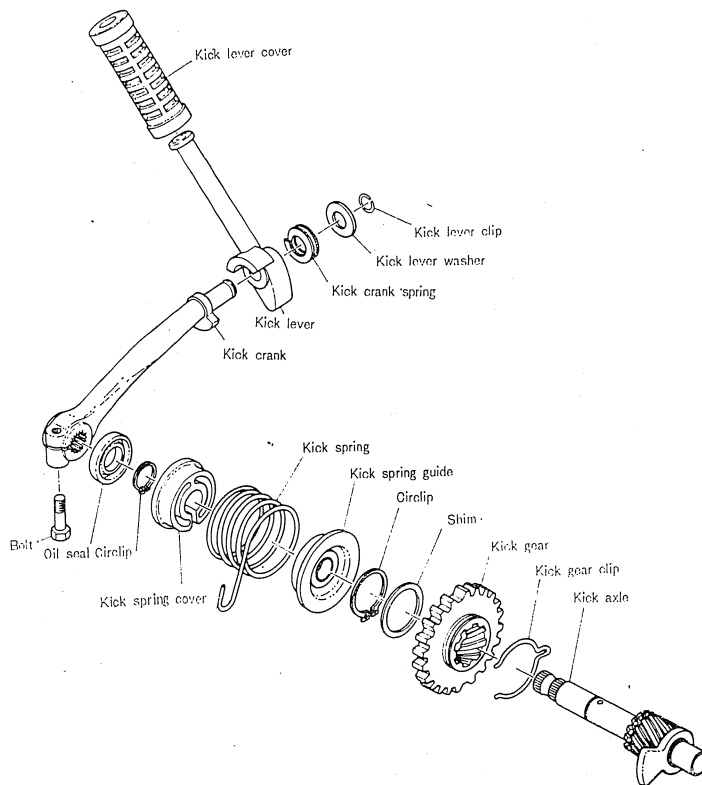

Fig. 5-1-4

6. Transmission Assembly

The transmission is designed for 5-speeds. The employment of new parts permits the engine to be built compactly with this transmission.

To assemble components parts, refer to the following drawing.

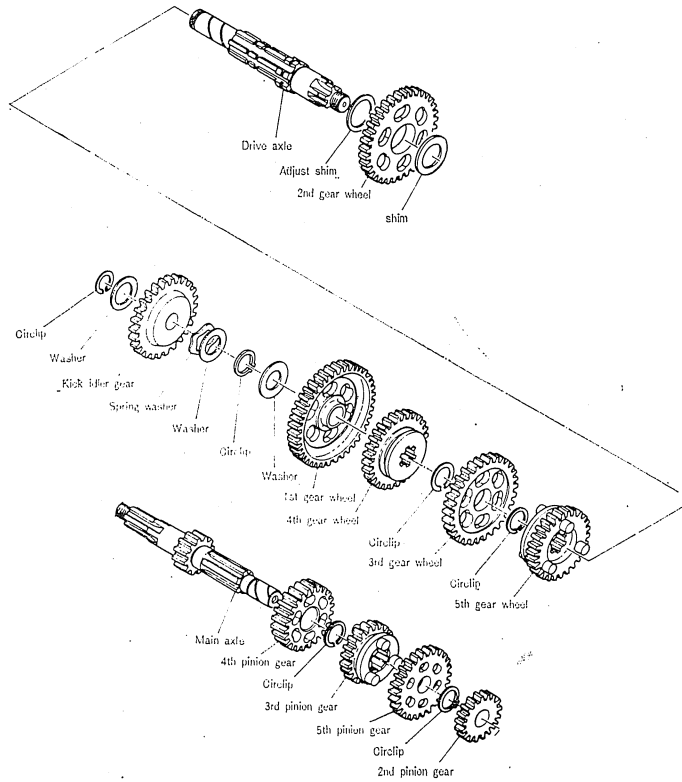

Fig. 5—1—5

7. Shifter Assembly

The drum type shifter allows the smooth shifting of gears.

8. Clutch Assembly

To reduce the weight, the number of component parts is decreased as follows.

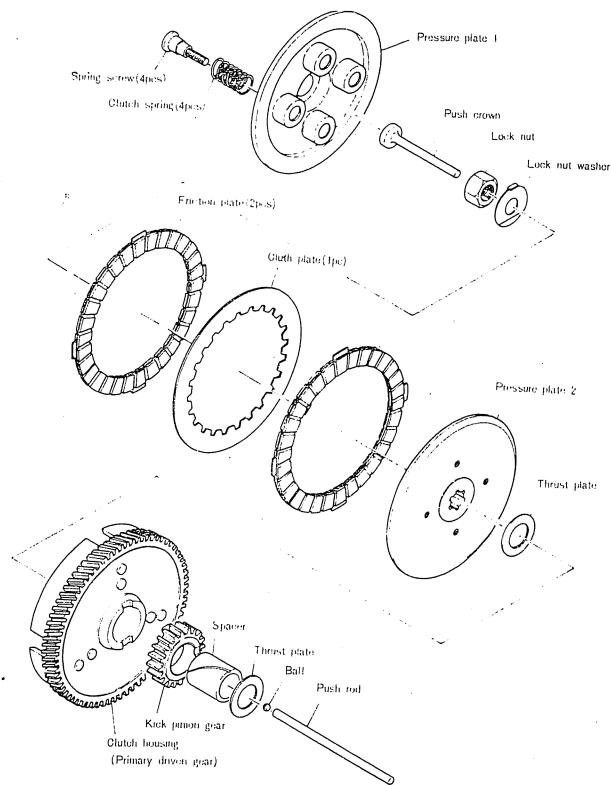

Fig. 5-1-6

V-2. CHASSIS

With the compact design of the engine, improvements are made aimed at ease of handling and riding as well as at a refined sports styling.

1. Front Fender/Rear Fender

Both front and rear fenders are chrome-plated to give deluxe appearance.

They differ in profile from those for the F5C and F5S, and the procedures for installation are also different, but they are interchangeable with those for these models.

(The front fender is a little shorter. Some consideration is required when it is used for other model.)

2. Rear Arm and Rear Cushion

Both rear arm and rear cushion are the same in design as those for the F5C. (The tension of the cushion is the same as in the case of the F5 and F5S, but the size of fittings differ.)

3. Chain Case

The chain case is of new design.

4. Fuel Tank and Dual Seat

New design of parts is employed to assure the smart profile as a truly racer.

On the F5C and F5S, the fuel tank and dual seat are installed as a unit assembly.

5. Front Wheel

The front wheel is the same in design as those for the F5 and F5S, and finished with baffing to give a touch of deluxe.

6. Rear Wheel

The rear wheel is the same in design as the F5C, except for the sprocket wheel. The hub is finished with baffing.

7. Main Stand

The main stand is the same in design as the F5.

8. Frame Complete

Because of the engine being smaller in width, the engine bracket is newly designed. The rest is the same as the F5C, but the frame complete is not interchangeable with that of the F5C.

9. Brake Pedal and Foot Rest

Because of the narrower width of the engine, both brake pedal and foot rest are not interchangeable with those for other models.

10. Handle Grips

The handle grips are the same in design as those of the YAS1. The handle bar is available in three types; upswept, semi-up and F5C type with bridge.

11. Front Fork Assembly

1) Steering Lock Key

The steering lock key is also usable as the main switch key. (It is double-edged symmetrically.)

The key is designed exclusively for the FS1.

2) The pitch (front fork width) differs from the F5S and F5C.

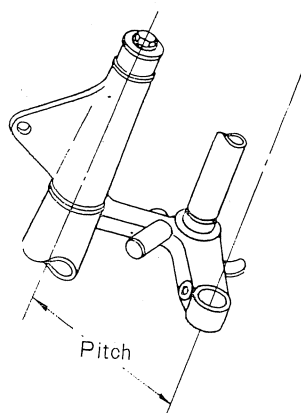

Fig. 5-2-1

FS1 pitch—148.2 mm

F5S pitch—156 mm

V—3. ELECTRICAL EQUIPMENT

1. List of Electrical Parts

Part	Maker	Description	Usable for
Engine: Flywheel magneto	Mitsubishi Elec. Hitachi	FAZ-1QL F11-L40 ○Spraking 7 mm or more/500 rpm 8 mm or more/5,000 rpm ○Charging (day time) 0.5 A or more/2,500 rpm (Battery voltage - 6.5V) 4 A or less/8,000 rpm (Battery voltage - 8.5V) ○Ignition 6.0V or more/2,500 rpm (Battery voltage 8.5V) 8.7V or less/8,000 rpm (Battery voltage 7.0V) ○Contact point 0.3-0.4 mm (point gap)	
Spark plug	NGK	B-8HC	
Neutral switch	Asahi Denso	YN-9	YL1
Frame: Battery	Furukawa Btry. Yuasa Btry.	BST2-6, 6 V, 4 AH	
Main switch	Asahi Denso	FS1M-002 (OFF, daytime, and night)	
Silicon rectifier	Fuji Elec.	CD2-H/1	F5, J5
Horn	Nikko Metal	MF6	F5, J5
Ignition coil	Mitsubishi Elec. Hitachi	HP-B1 CM61-14B	F5, J5
Flasher relay	Showa Denki	B-9, 6V, 8W×2+3W Flashing 50-120/min.	F5C
Fuse holder	Osachi	10 A, 2 pcs.	F5, J5
Stop switch	Asahi Denso	YS10	F5, J5, G5
Front: Headlight	Koito	6V, 15W/15W	
Speedometer	Nippon Seiki	YA127	

Front flasher light	Imasen Elec.	FLF-Y207, 6V, 8W	F5, J5 (chrome-plated)
Handle lever holder (right)	Asahi Denso	YG6H (for YL1 bar handle)	YLI
Handle lever holder (left)	Asahi Denso	YG6H (for YL1 bar handle)	YLI
Rear:			
Taillight	Stanley	6V, 3W	F5, J5
Stop light	Stanley	6V, 10W	F5, J5
Rear flasher light	Imasen Elec.	FLR-Y207, 6V, 8W	F5, J5 (chrome-plated)

2. Principal Modifications

1) Main Switch Assembly

For convenience of the rider, the main switch key is made usable as the steering lock key, with symmetrical double-edge design. It is exclusively for the FS1.

2) Flasher Light

For additional safety, the flasher lights are made larger, and chrome-plated.

3) Speedometer

The speedometer is mounted separately from the headlight, and at the same time, design consideration is given for functional beauty.

3. Connection Diagram

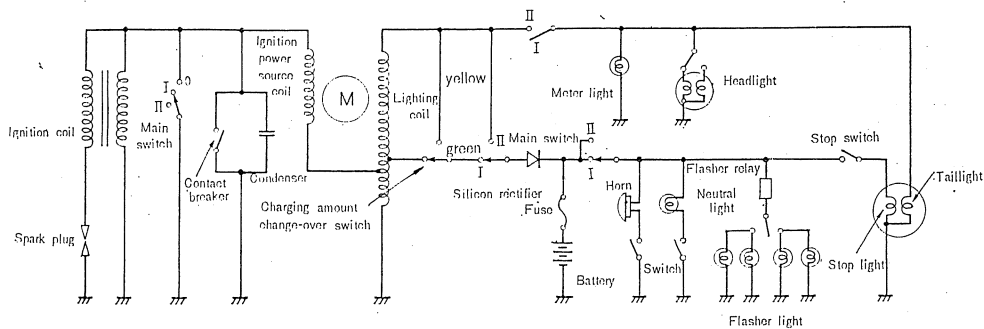

Fig. 5-3-1

4. Checking of Parts

1) Ignition Timing Adjustment

The correct ignition timing can be assured simply by adjusting the maximum point gap to the specified value (0.30-0.40 mm).

It is noted that there is another way of adjusting the ignition timing by use of the electrotester timing light and the match markings.

2) Ignition Coil

As shown Fig. 5-3-2, connect the wires for checking.

1. Primary ignition coil resistance $0.6\Omega \pm 10\%$
2. Secondary ignition coil resistance $5k\Omega \pm 10\%$

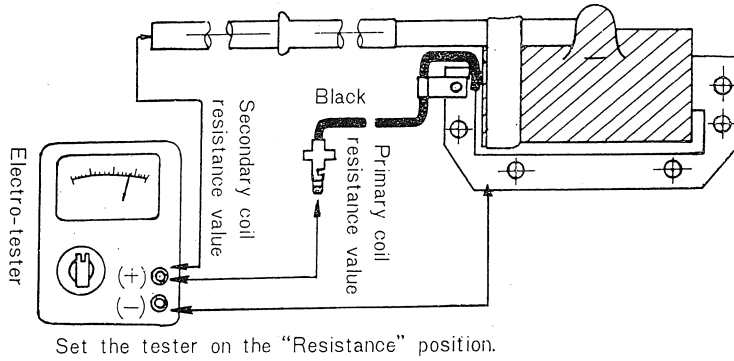

Fig. 5-3-2

Note: If the secondary coil resistance is measured with the plug cap installed, a 5 kΩ of internal resistance (for noise elimination) will be added to the value.

Sparking

Sparks should be 7mm or more, with a battery of 6V capacity.

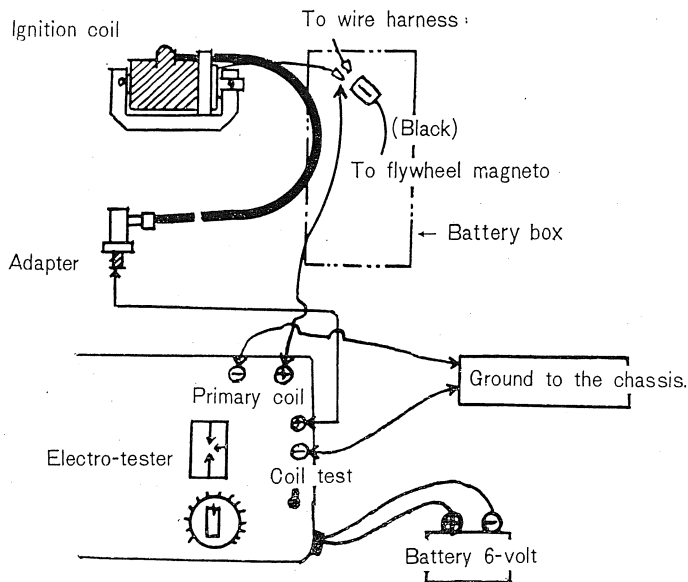

Fig. 5-3-3

Note: When the coil (removed from the machine) is tested for sparking, connect the negative wires on the primary and secondary sides of the tester to the core bar of the ignition coil. The power source for this test should be a 6-volt battery.

3) Condenser

a. Insulation resistance test

As shown in the figure below, hook up the tester. If the needle fully swings and swing back to stay at $3M\Omega$, the condenser is in good condition.

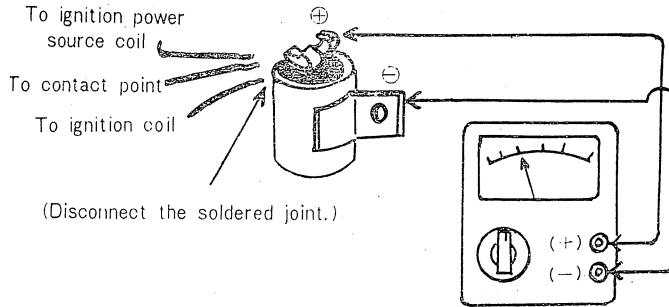

Set the electro-tester on the " $M\Omega$ " position

Fig. 5-3-4

Note: After measurement, connect the positive terminal to the negative by a thick lead wire so that the condenser will be discharged.

b. Capacity Test

To test the capacity of the condenser, hook up the tester as shown in the above figure, and then set the tester knob on the same value as the capacity of the condenser.

If the measured value is at $0.22 \mu F \pm 10\%$ the condenser is in good condition.

4) Measuring Charging Current

As shown in the figure below, hook up the tester, and measure the charging current with the specified rpm.

0.5 A or more/2,500 rpm. (battery voltage - 6.5V)

4 A or less/8,000 rpm. (battery voltage - 8.5V)

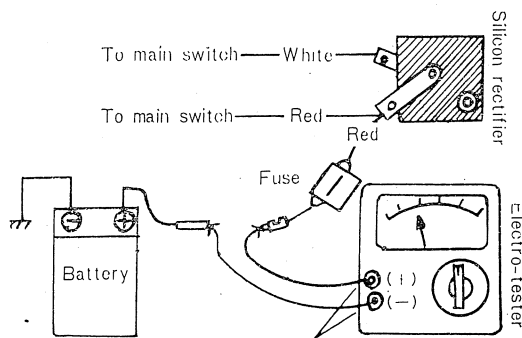

(Set the knob on "DC20A")

Fig. 5-3-5

Note: The measurement should be conducted with the main switch being set on "daytime," that is, no load, such as neutral pilot light, is consuming electricity.

If the battery voltage differs from the value in parenthesis, the charging current will be affected. Therefore, the battery charge should be measured and adjusted to the specific value before the test.

5) Checking the Silicon Rectifier

Checking with normal connection

As shown in the figure below, hook up the tester for measurement.

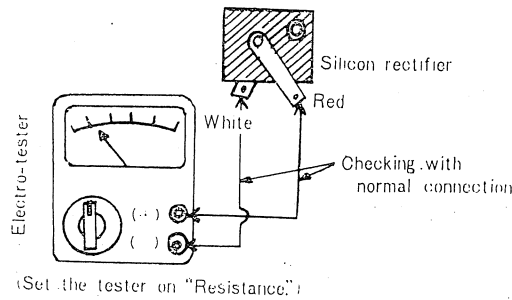

Fig. 5-3-6

Standard Value.....9 - 10Ω

If the needle will not swing at all or not swing back from the over scale, the rectifier is defective.

Checking with reversal connection

Check the rectifier with reversal connection.

If the needle will not swing, the rectifier is in good condition.

If the needle will swing, the rectifier is defective.

6) Magneto Output Voltage

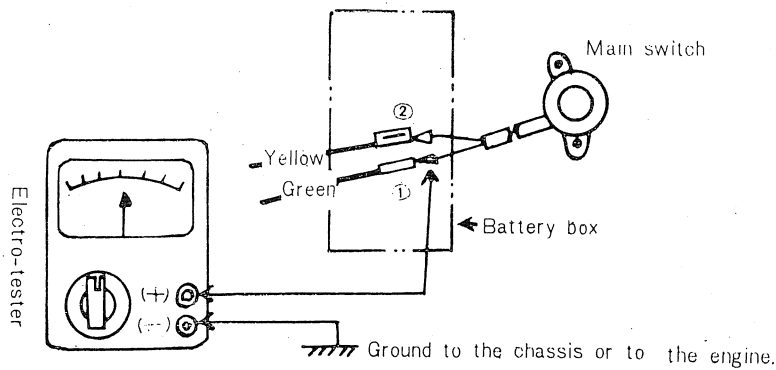

(Set the tester on the "A.C. Voltage" position.)

Fig. 5-3-7

To measure the output voltage during the day time, connect the positive wire of the tester to the green connector in parallel as in the figure above (do not disconnect the connector), and make sure that any voltage can be affected with the switch set on "day-time".

To measure the night-time output voltage, connect the positive wire of the tester with the yellow connector in parallel, and make sure that the voltage is 5.8 volts or more with the engine running at 2,500 rpm.

Be sure that the main switch is set on "night," and no extra light is turned on.

7) Inspecting Wiring and Switch Connection

As shown in the figure below, hook up the tester. If the voltage measured is 5.8 volts or more with engine speed at 2,500 rpm, both wiring and main switch are in good condition. This is applicable for both daytime and night.

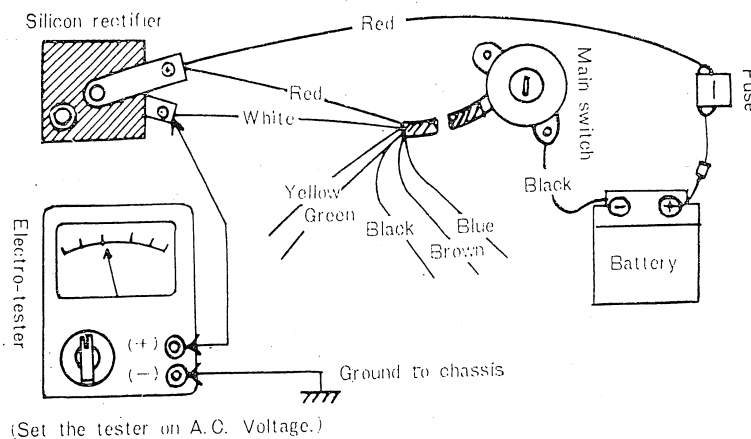

Fig. 5-3-8

8) Checking the Main Switch Removed from the Chassis

Key in "O" (Off.)

Black ↔ Switch body

Key in "I" (daytime)

Green ↔ White

Red ↔ Brown

Key in "II" (night)

Yellow ↔ White

White ↔ Blue

Red ↔ Brown

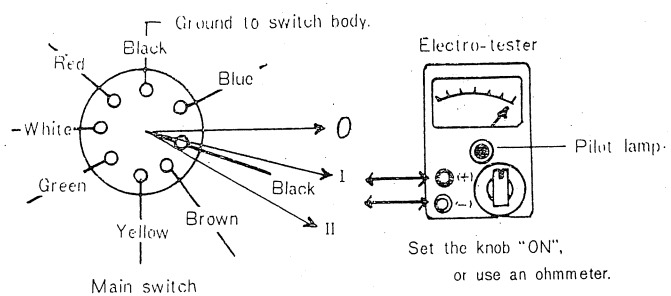

Fig. 5-3-9

The measured resistance at the above six places should be nearly 0Ω , and complete insulation should be maintained between terminals, and between each lead wire and switch body.

9) Battery Service Data

Battery model:	BST2-6, 6 V, 4 AH	
Maker:	Furukawa Battery or Yuasa Battery	
Electrolyte specific weight	1.26 - 1.28	When fully charged.
Electrolyte volume	170 cc	
Initial charging current	25 hours at 0.4 A	New machine
Charging current (afterwards)	13 hours at 0.4 A (Charge so that the specific gravity of electrolyte will be 1.26-1.28.)	When discharged.
Water to added	Ditilled water (Fill so that the level will reach the maximum.)	Monthly

VI SERVICE DATA

1. Piston Clearance

0.035—0.040 mm

2. Crankshaft

Crankshaft assembly service data

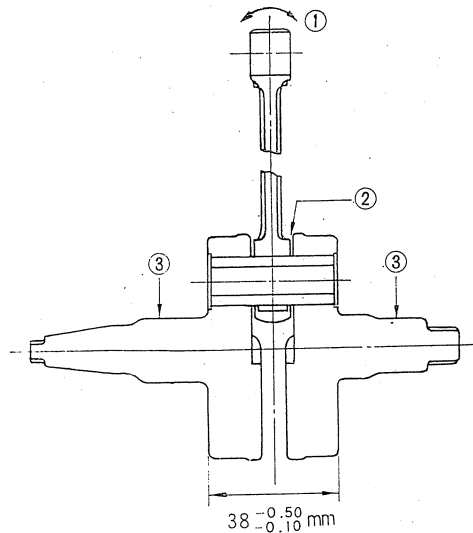

Fig. 6-6-1

1) Axial play at small end of connecting rod

(In order to measure the wear of crank pin and needle bearing at large end)

0.8—1.0 mm

If more than 2.0 mm, replace worn parts.

2) Axial clearance at large end of connecting rod

0.4—0.5 mm

If more than 0.6 mm, replace worn parts.

3) Runout of crankshaft

0.05 mm or less

3. Gear Box Oil

- 1) Oil: Motor oil SAE 10W/30
- 2) Oil quantity: 600—650 cc (0.65 US qt.)

4. Oil Pump

- 1) Minimum stroke: 0.20—0.25 mm (If less than 0.15 mm, adjust with shim.)
- 2) Adjusting pump and carburetor

The pump adjust pelley guide pin should be aligned with the match mark on the adjusting pulley, when the throttle opens half.

5. Ignition System

- 1) Spark plugNGK—B-8HC, (Champion—L57R, Bosch—W270T16)
- 2) Spark plug gap0.5—0.6 mm (0.020—0.024 in.)
- 3) Ignition timing1.8±0.15 mm BTDC
- 4) Point gap0.3—0.4 mm

6. Front Fork

- 1) Oil: Motor oil SAE 10W/30 or 8:2 mixture of mobile oil #30 spindle oil #60
- 2) Quantity: Left—135 cc (3.98 f l.oz.) Right—140 cc (4.14 f l.oz.)

7. Carburetor Setting

Model	VM16SC
Marking	260E1
M. J. (Main jet)	160
J. N. (Jet needle)	3G9-3
N. J. (Needle jet)	E-2
C. A. (Throttle valve cut-away)	2.0
P. J. (Pilot jet)	25
A. S. (Air screw backing off)	1.0
G. S. (Starter jet)	60
V. S. (Valve seat)	1.2
Gas level	23.0±1.0 mm
Idling RPM	1,250-1,350 rpm

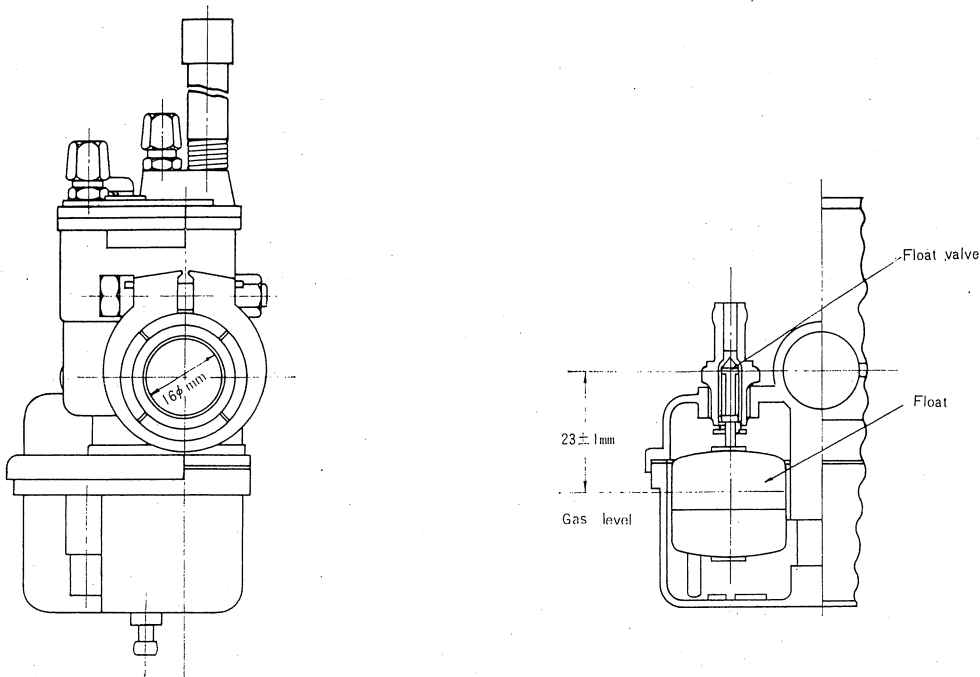
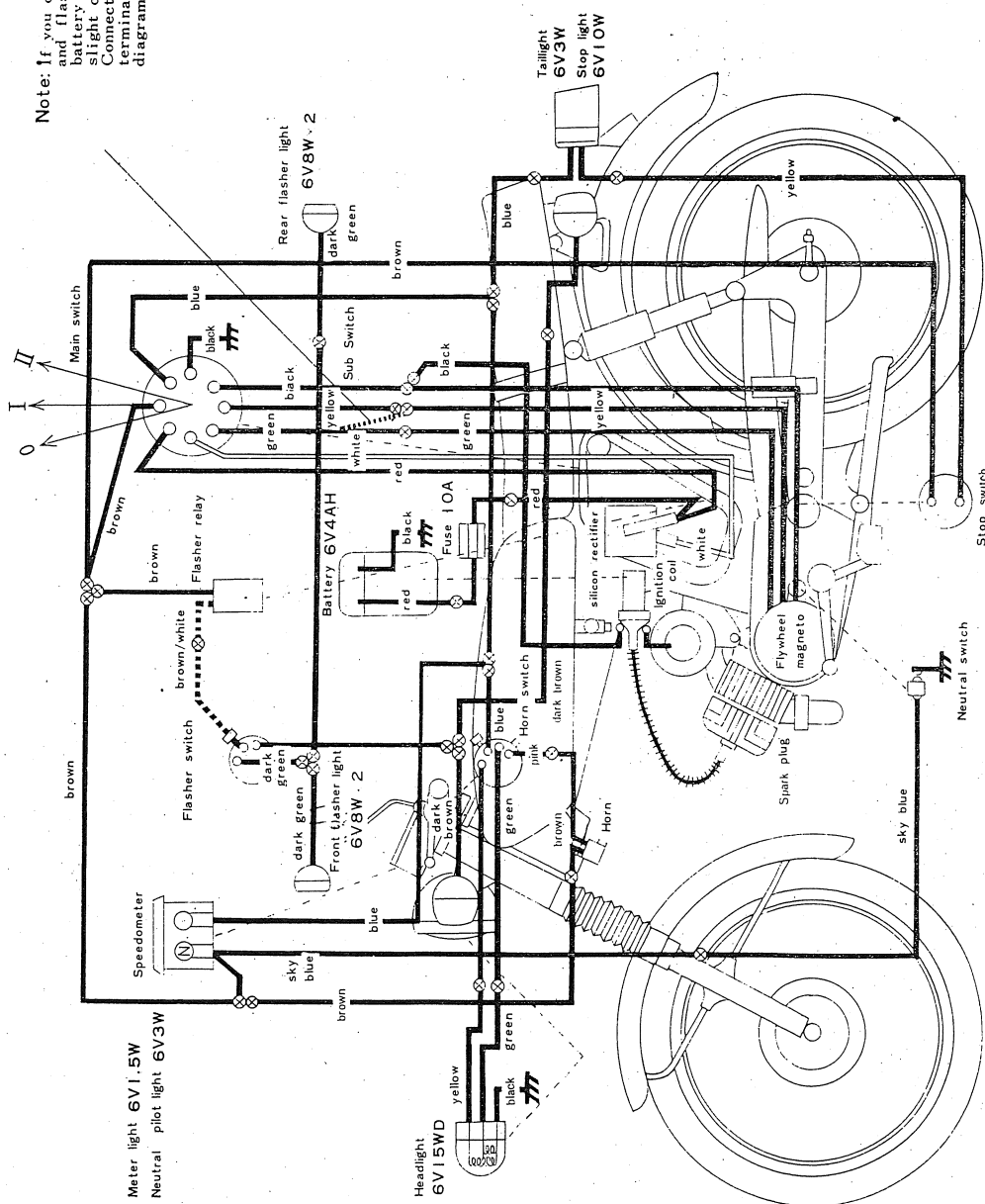

Fig. 6-6-2

VII WIRING DIAGRAM

Note: If you often drive at slow speed or use the stop, light and flasher lights frequently, in other words, if the battery is rather discharged, you will do the following slight change in the circuit for the better charging. Connect the green lead wire of the main switch to the terminal of the yellow as illustrated in the circuit diagram with a dotted line.



Circuit connected by main switch

color position	black-earth	green-white	yellow-white	yellow-blue	Red-brown
I	○	○	×	×	○
II	×	×	○	○	○

Chart of wire colors

Engine Stop Circuit	black
Magnet (for day driving) Circuit	green
Magnet (for night driving) Circuit	yellow
Battery (+) Circuit	red
Earth Circuit	black
Silicon Circuit	white
Stop Light Circuit	yellow
Neutral Light Circuit	sky blue
Light Circuit	blue
Flasher(R) Circuit	dark green
Flasher(L) Circuit	dark brown
Common Circuit	brown
Headlight Main Circuit	yellow
Headlight Sub Circuit	green
Horn Circuit	pink
Flasher Relay Circuit	white/brown



YAMAHA MOTOR CO., LTD.