

## **Workshop Manual**

**Yamaha FS1E 1972-**

# Yamaha FS1-E Sixteener Special Owners Workshop Manual

---

by Mervyn Bleach

---

**Models covered:**

All FS1-E mopeds from 1972 onwards

---

## Acknowledgements

---

Our grateful thanks are due to Lawrie Hockley of W and H Brockliss Limited, 334, Brockley Road, London, S.E. 4 who provided much useful information based on their wide experience as Yamaha repair specialists. Brian Horsfall gave the necessary assistance with the overhaul and devised ingenious methods for the Avon Rubber Company, who kindly supplied illustrations and advice about tyre fitting.

overcoming the lack of service tools. Les Brazier arranged and took the photographs that accompany the text. Jeff Ciew edited the text.

We are also indebted to Yeovil Motorcycle Services Ltd for their permission to photograph the FS1E - DX model shown on the front cover.

## About this manual

---

The author of this manual has the conviction that the only way in which a meaningful and easy to follow text can be written is first to do the work himself, under conditions similar to those found in the average household. As a result the hands seen in the photographs are those of the author. Even the machines are not new; examples that had covered a considerable mileage were selected so that the conditions encountered would be typical of these found by the average owner. Unless specially mentioned, and therefore considered essential, Yamaha special service tools have not been used. There is invariably some alternative means of loosening or removing a vital component when service tools are not available but risk of damage should always be avoided.

Each of the seven chapters is divided into numbered sections. Within these sections are numbered paragraphs. Cross reference throughout the manual is quite straightforward and logical.

When reference is made 'See Section 6.10' it means Section 6 paragraph 10 in the same Chapter. If another chapter were meant, the reference would read 'See Chapter 2 Section 6.10'. All the paragraphs are captioned with a section/paragraph number to which they refer, and are relevant to the chapter text adjacent.

Figures (usually line illustrations) appear in a logical but numerical order, within a given chapter. Fig.1.1 therefore, refers to the first figure in Chapter one.

Left-hand and right-hand descriptions of the machines and their components refer to the left and right of a given machine when the rider is seated normally. Whilst every care is taken to ensure that the information in this manual is correct no liability can be accepted by the authors or publishers for loss, damage or injury, caused by any errors in or omissions from the information given.

## Introduction to the Yamaha FS1-E

---

The Yamaha FS1-E is a 50 cc motorcycle complete with four speed gearbox, manual clutch and kickstarter. So that the sixteen year old age group is eligible to ride the machine pedals are fitted. The machine is then classified as a moped. Unlike many other mopeds the pedals can be fixed in footrest positions for proper control of the machine.

For people of seventeen and over who wish to take their Group

D motor cycle test, the pedalling gear should be removed completely, and a footrest bar with footrests substituted. By definition, a moped is a motor cycle with an engine of not more than 50 cc capacity, fitted with a means of propelling the machine by the feet. If the pedalling gear is removed and a footrest bar and footrests substituted, the machine then becomes a miniature motor cycle, which can be used by the rider for his Group D test.

# Contents

| Chapter                               | Section                          | Page |
|---------------------------------------|----------------------------------|------|
| Introductory pages                    | Introduction to the Yamaha FS1-E | 2    |
|                                       | Ordering spare parts             | 6    |
|                                       | Routine maintenance              | 7    |
|                                       | List of illustrations            | 9    |
|                                       | Recommended lubricants           | 11   |
| Chapter 1/Engine, clutch and gearbox  | Specifications                   | 12   |
|                                       | Engine/gearbox removal           | 13   |
|                                       | Dismantling                      | 15   |
|                                       | Examination and renovation       | 33   |
|                                       | Reassembly                       | 34   |
|                                       | Fault diagnosis                  | 45   |
| Chapter 2/Fuel system and lubrication | Specifications                   | 47   |
|                                       | Petrol tank and tap              | 47   |
|                                       | Carburettor                      | 48   |
|                                       | Fault diagnosis                  | 54   |
| Chapter 3/Ignition system             | Specifications                   | 55   |
|                                       | Ignition coils                   | 55   |
|                                       | Contact breakers                 | 55   |
|                                       | Condenser                        | 58   |
|                                       | Spark plugs                      | 59   |
|                                       | Fault diagnosis                  | 60   |
| Chapter 4/Frame and forks             | Front forks                      | 61   |
|                                       | Steering heads                   | 66   |
|                                       | Frame                            | 67   |
|                                       | Swinging arm                     | 67   |
|                                       | Rear suspension                  | 67   |
|                                       | Fault diagnosis                  | 71   |
| Chapter 5/Wheels, brakes and tyres    | Specifications                   | 72   |
|                                       | Front wheel                      | 72   |
|                                       | Front brake                      | 73   |
|                                       | Rear wheel                       | 75   |
|                                       | Final drive                      | 79   |
|                                       | Tyres                            | 79   |
|                                       | Fault diagnosis                  | 81   |
| Chapter 6/Electrical system           | Specifications                   | 82   |
|                                       | Battery - examination            | 82   |
|                                       | Silicon rectifier                | 83   |
|                                       | Lights                           | 83   |
|                                       | Fault diagnosis                  | 86   |
| Chapter 7/The FS1E-DX model           |                                  | 88   |
| Index                                 |                                  | 92   |

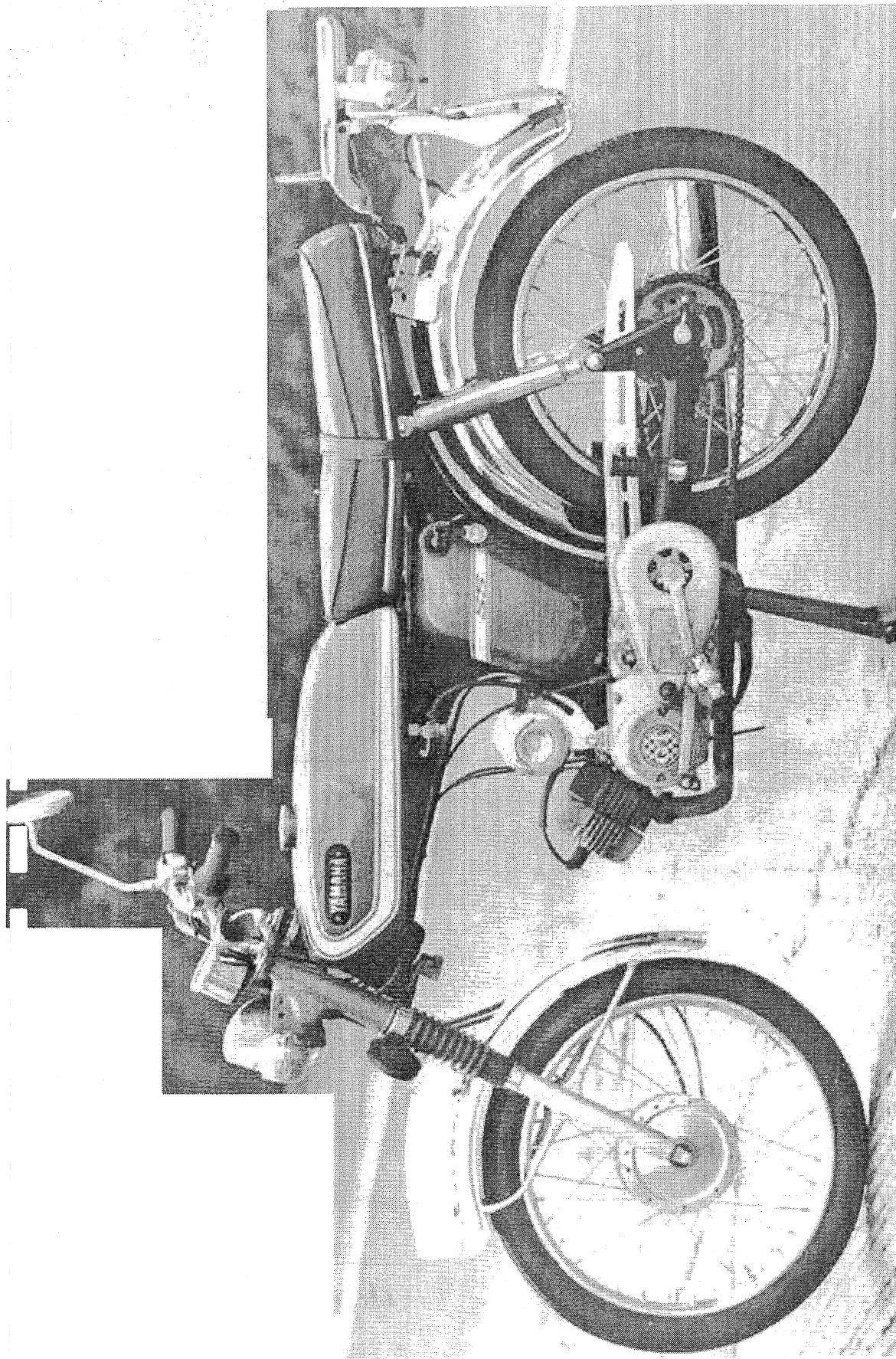

Left-hand side view of the 49cc Yamaha FSE-1

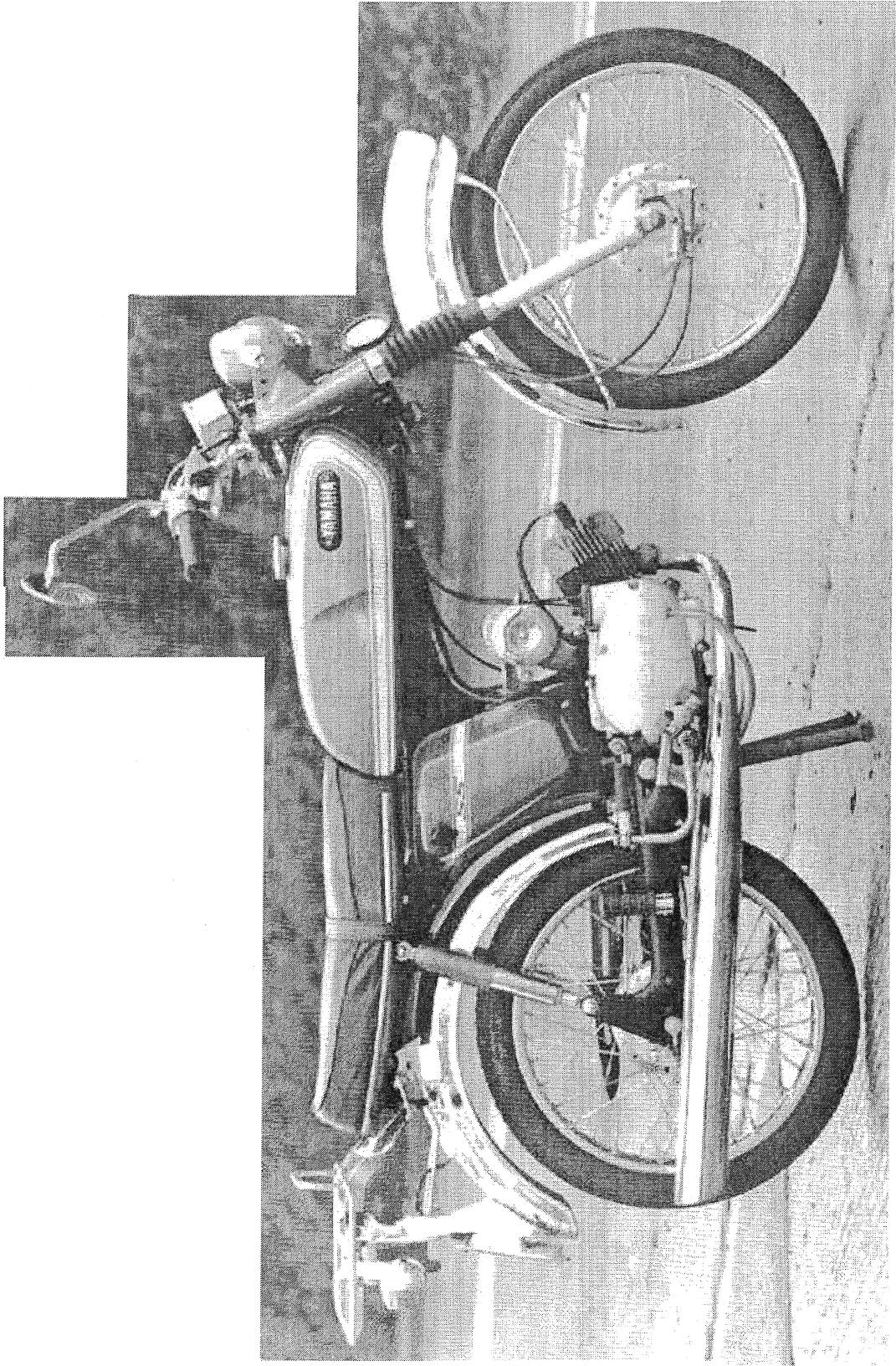

Right-hand side view of the 49cc Yamaha FSE-1

## Ordering spare parts

When replacement parts are required for the Yamaha FS1-E, it is advisable to deal direct with a recognised Yamaha agent or with the area distributor. They are better placed to supply the parts ex-stock and should have the technical experience that may not be available with other suppliers. When ordering parts, always quote the engine and frame numbers in full, since these will identify the model and its date of manufacture. Although the FS1-E is still comparatively new, it will sometimes help if the old part is presented when the replacement is ordered, to aid correct identification.

Always fit replacement parts of Yamaha manufacture and do not be tempted to use pattern parts, which sometimes have a price advantage. Although the pattern parts may appear similar they often give inferior service and may prove more expensive in

the long run.

The engine number is stamped on the left hand crankcase immediately in front of the clutch cable. The frame number is stamped on the right hand side of the steering head.

Some of the more expendable parts such as spark plugs, bulbs, tyres, oils and greases etc., can be obtained from accessory shops and motor factors, who have convenient opening hours, charge lower prices and can often be found not far from home. It is also possible to obtain parts on a Mail Order basis from a number of specialists who advertise regularly in the motor cycle magazines.



Engine No. location

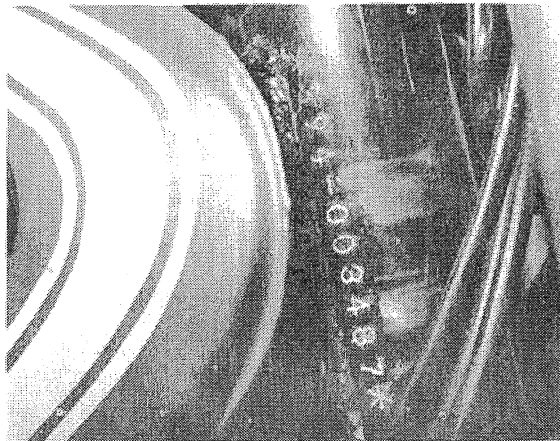

Frame number location

## Routine maintenance

Periodic routine maintenance is a continuous process that commences immediately the machine is used. It must be carried out at specified mileage recordings or on a calendar basis if the machine is not used frequently, whichever falls soonest. Maintenance should be regarded as an insurance policy, to help keep the machine in the peak of condition and to ensure long, trouble-free service. It has the additional benefit of giving early warning of any faults that may develop and will act as a regular safety check, to the obvious advantage of both rider and machine alike.

The various maintenance tasks are described under their respective mileage and calendar headings. Accompanying diagrams

are provided, where necessary. It should be remembered that the interval between the various maintenance tasks serves only as a guide. As the machine gets older or is used under particularly adverse conditions, it would be advisable to reduce the period between each check.

Some of the tasks are described in detail, where they are not mentioned fully as a routine maintenance item in the text. If a specific item is mentioned but not described in detail, it will be covered fully in the appropriate Chapter. No special tools are required for the normal routine maintenance tasks. The tools contained in the kit supplied with every new machine will prove adequate for each task or if they are not available, the tools found in the average household should suffice.

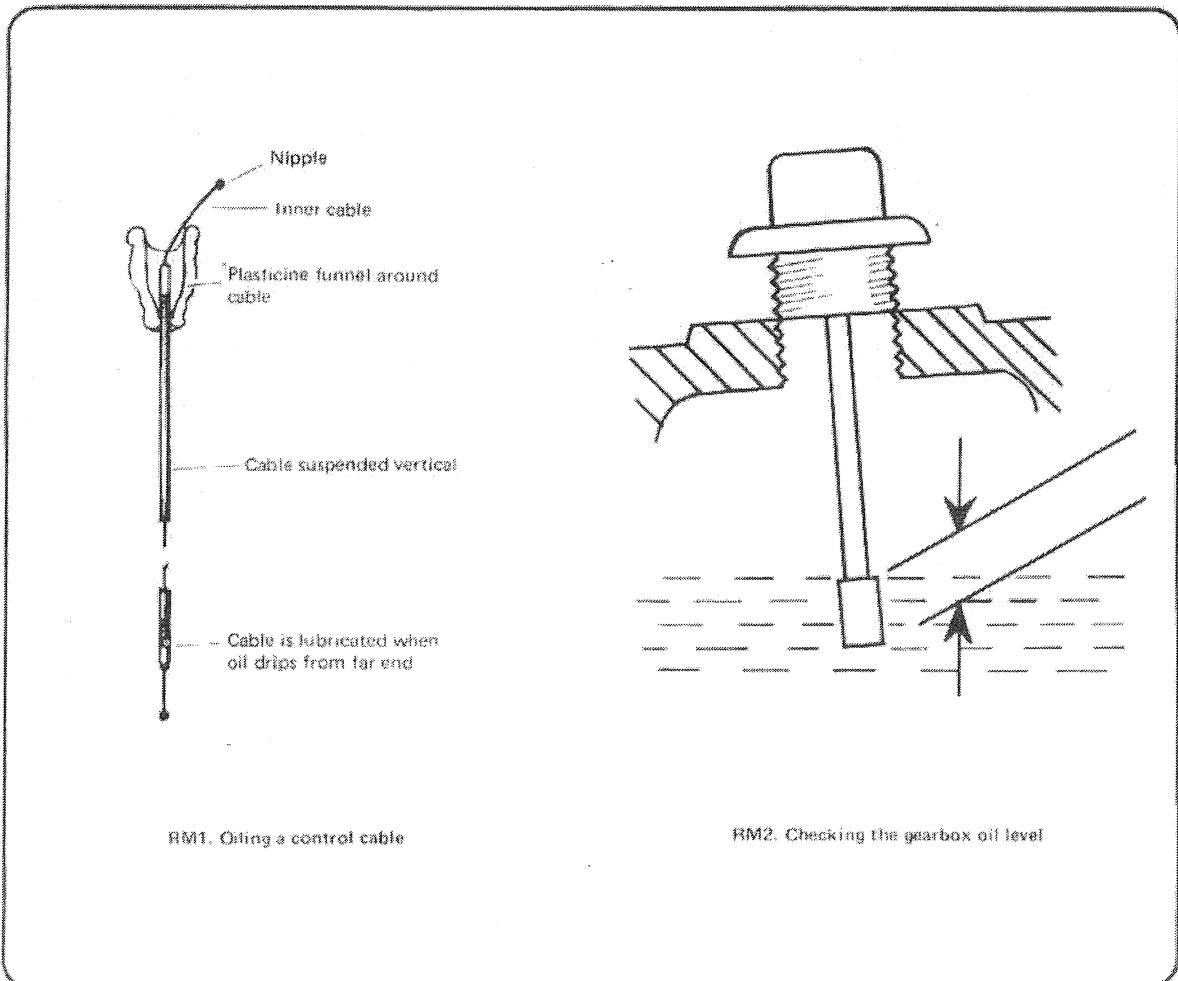



---

**Weekly or every 300 miles (500 km)**

---

Check the tyre pressures. Always check with the tyres cold, using a pressure gauge known to be accurate.

Check the transmission oil level and top up if necessary. If the oil level is correct it will show on the dipstick but the dipstick must not be screwed in when checking the level.

Oil and adjust the brake and clutch cables.

Check the acid level in the battery and top up with distilled water if necessary.

Check and, if necessary, adjust the tension of the drive chain. Make sure the chain is well lubricated.

---

**Monthly or every 1000 miles (1600 km)**

---

Complete all the checks listed in the weekly/300 mile service, and the following items:

Check the spark plug gap. If the electrodes are wearing thin, or if the outer electrode has to be bent excessively to restore the gap, fit a new plug.

Change the transmission oil.

Clean the carburettor, fuel tap and feed pipe. If necessary, adjust the slow running speed. Clean also the air filter.

Remove, clean and lubricate the drive chain.

Check the contact breaker gap and adjust if necessary.

Check lighting system.

---

**Six monthly or every 3000 miles (5000 km)**

---

Complete all the checks under the weekly and monthly headings, then carry out the following additional tasks:

Decarbonise the engine and clean out the exhaust system.

Grease the centre stand pivot.

Grease the speedometer drive gears.

Lubricate the control cables, adjusting screws for front brake, rear brake and clutch.

---

**Yearly or every 6000 miles (10,000 km)**

---

Again complete all the checks listed under the weekly, monthly and six monthly headings, but only if they are not directly connected with the tasks listed below. Then complete the following:

Lubricate the felt wick of the contact breaker cam.

Check and, if necessary, replace both the final drive and pedalling gear chains. Check also the condition of the sprockets.

Adjust and lubricate the steering head bearings.

Dismantle both front and rear brake assemblies and examine the brake shoe linings. Replace the brake shoes if the linings are thin or if the leverage of the brake operating arm is reduced. Repack the bearings with grease.

## List of illustrations

| Fig. No.           | Caption  | Page |
|--------------------|--|------|
| Lubrication points |  |      |
| 1.1.               | Crankcase covers                                     | 10   |
| 1.2.               | Crankcase and cylinder assembly                      | 14   |
| 1.3.               | Clutch   | 20   |
| 1.4.               | Kickstarter assembly                                 | 23   |
| 1.5.               | Crankshaft, piston and disc valve                    | 25   |
| 1.6.               | Gearbox components                                   | 27   |
| 1.7.               | Gearchange mechanism                                 | 30   |
| 1.8.               | Gear selector drum                                   | 31   |
| 1.9.               | Pedal engagement assembly                            | 32   |
| 2.1.               | Fuel tank  | 43   |
| 2.2.               | Carburettor  | 49   |
| 2.3.               | Exhaust pipe and silencer                            | 50   |
| 3.1.               | Flywheel generator (Mitsubishi)                      | 53   |
| 3.2.               | Flywheel generator (Hitachi) (alternative equipment) | 56   |
| 3.3a.              | Spark plug maintenance                               | 57   |
| 3.3b.              | Spark plug electrode conditions                      | 59   |
| 4.1.               | Steering head assembly                               | 59   |
| 4.2.               | Front forks  | 62   |
| 4.3.               | Frame assembly                                       | 63   |
| 4.4.               | Swinging arm fork and suspension units               | 69   |
| 5.1.               | Front wheel  | 70   |
| 5.2.               | Rear wheel and shock absorber                        | 74   |
| 5.3.               | Checking wheel alignment                             | 77   |
| 5.4a.              | Tyre removal   | 78   |
| 5.4b.              | Tyre fitting   | 80   |
| 6.1.               | Electrical components                                | 80   |
| 6.2.               | Connection diagram                                   | 84   |
| 6.3.               | FS1-E Wiring diagram                                 | 87   |
| 7.1.               | Bleeding the front disc brake                        | 91   |

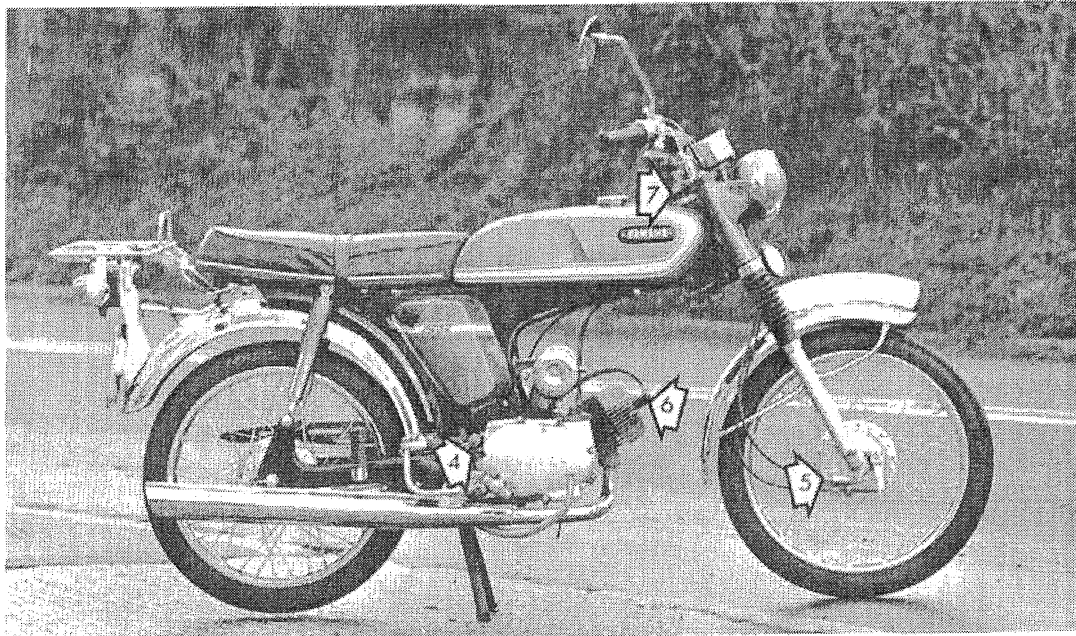
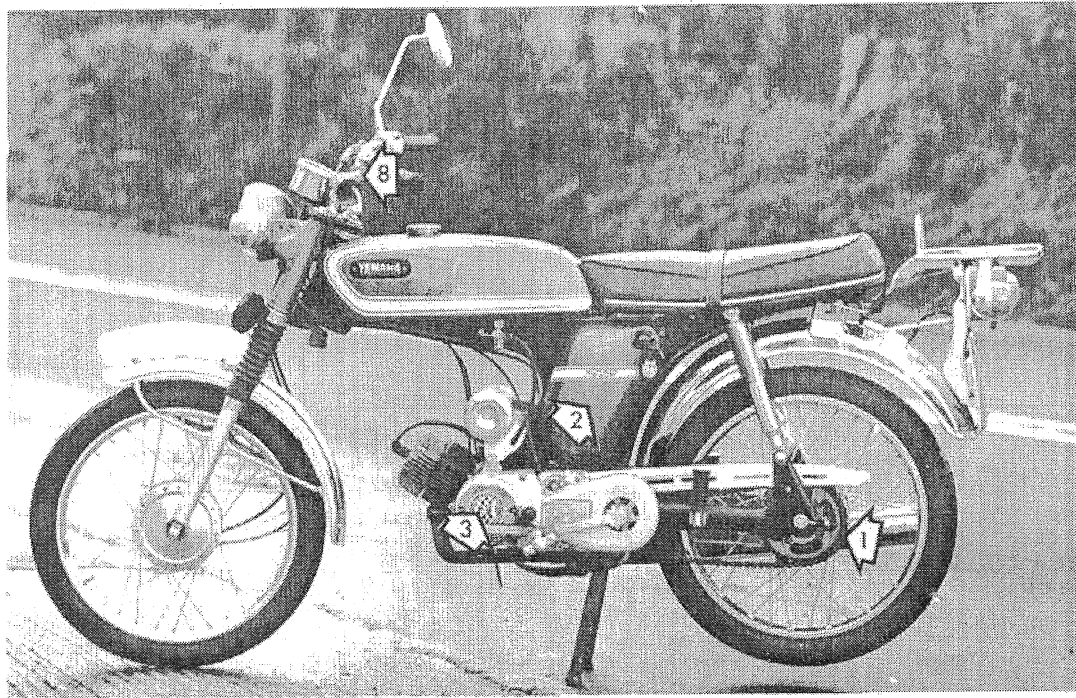

## Lubrication chart

- 1 Remove, clean and lubricate final drive chain; check tension
- 2 Check acid level of battery
- 3 Check points gap and lubricate wick of contact breaker cam
- 4 Check oil level regularly
- 5 Grease speedometer drive
- 6 Clean and adjust sparking plug
- 7 Grease steering head bearings
- 8 Lubricate control cables

# Recommended lubricants

| COMPONENT           | TYPE OF LUBRICANT   | CORRECT CASTROL PRODUCTS                |
|---------------------|---|---|
| ENGINE              | Self-mixing two stroke oil<br>Mix in ratio 1 part of oil to 20 parts petrol (8 fl oz./gallon) | Castrol TT Two Stroke Oil               |
| GEARBOX             | SAE 30 motor oil or 20W/50 engine oil   | Castrol GTX                             |
| FINAL DRIVE CHAIN   | Multi-grade oil or graphited grease   | Castrol GTX<br>Castrol Graphited Grease |
| ALL GREASING POINTS | Multi-purpose high melting point lithium based grease   | Castrol LM Grease                       |

## Dimensions and weights

|                              |                   |
|------------------------------|-------------------|
| Dimensions and weights:      |                   |
| Overall length               | 69.1 in (1755 mm) |
| Overall width                | 21.9 in (555 mm)  |
| Overall height               | 36.8 in (935 mm)  |
| Wheelbase                    | 45.7 in (1160 mm) |
| Ground clearance (unloaded)  | 5.3 in (135 mm)   |
| Dry weight                   | 154 lb (70 kg)    |
| Performance and consumption: |                   |
| Maximum speed                | 45 mph (73 kph)   |
| Climbing ability             | 18° (1 in 3)      |

# Chapter 1 Engine clutch and gearbox

## Contents

|   |    |  |    |
|---|----|--|----|
| General description ... ..  | 1  | Crankcases - examination and renovation ... ..                                 | 24 |
| Operations with engine in frame ... ..  | 2  | Clutch actuating mechanism - examination ... ..                                | 25 |
| Operations with engine removed ... ..   | 3  | Clutch assembly - examination and renovation ... ..                            | 26 |
| Method of engine/gearbox removal ... ..   | 4  | Primary gear pinions - examination ... ..                                      | 27 |
| Removing the engine/gearbox ... ..  | 5  | Reassembly - general ... ..  | 28 |
| Dismantling the engine, clutch and gearbox - general ... ..                                       | 6  | Engine reassembly - fitting bearings to crankcases ... ..                      | 29 |
| Generator - removal ... ..  | 7  | Engine reassembly - fitting the crankshaft assembly ... ..                     | 30 |
| Dismantling the engine, clutch and gearbox - removing the cylinder head, barrel and piston ... .. | 8  | Engine reassembly - gearbox components ... ..                                  | 31 |
| Gearbox final drive sprocket - removal ... ..   | 9  | Engine reassembly - rejoining the crankcases ... ..                            | 32 |
| Clutch - dismantling and removal ... ..   | 10 | Engine reassembly - reassembling the disc valve ... ..                         | 33 |
| Kickstarter mechanism - removal ... ..  | 11 | Engine reassembly - reassembling the gearchange mechanism and index arm ... .. | 34 |
| Gearchange mechanism and index arm ... ..   | 12 | Engine reassembly - reassembling the kickstarter assembly ... ..               | 35 |
| Disc valve - removal ... ..   | 13 | Engine reassembly - reassembling the clutch ... ..                             | 36 |
| Separating the crankcases ... ..  | 14 | Engine reassembly - replacing the final drive sprocket and oil seal ... ..     | 37 |
| Gearbox components - removal ... ..   | 15 | Engine reassembly - fitting the flywheel magneto generator ... ..              | 38 |
| Crankshaft assembly - removal ... ..  | 16 | Engine reassembly - fitting the piston and cylinder barrel ... ..              | 39 |
| Crankshaft and gearbox main bearings - removal ... ..   | 17 | Refitting the engine/gearbox unit in the frame ... ..                          | 40 |
| Oil seals - examination ... ..  | 18 | Starting and running the rebuilt engine ... ..                                 | 41 |
| Crankshaft assembly - examination and renovation ... ..   | 19 | Fault diagnosis - engine ... ..  | 42 |
| Cylinder barrel - examination and renovation ... ..   | 20 | Fault diagnosis - clutch ... ..  | 43 |
| Piston and piston rings - examination and renovation ... ..                                       | 21 | Fault diagnosis - gearbox ... ..   | 44 |
| Small end - examination and renovation ... ..   | 22 |  |    |
| Cylinder head - examination and renovation ... ..   | 23 |  |    |

## Specifications

|                            |   |  |
|----------------------------|---|--|
| <b>Engine:</b>             |   |  |
| Type ... ..                | Two-stroke, with loop scavenging and rotary disc inlet valve  |  |
| Cylinder head ... ..       | Aluminium alloy, deeply finned  |  |
| Cylinder barrel ... ..     | Cast iron, deeply finned  |  |
| Bore ... ..                | 40 mm   |  |
| Stroke ... ..              | 39.7 mm   |  |
| Capacity ... ..            | 49 cc   |  |
| Bhp ... ..                 | 4.8 bhp at 7,000 rpm  |  |
| Compression ratio ... ..   | 7 : 1   |  |
| Petrol/oil ratio ... ..    | 20 : 1  |  |
| <b>Piston:</b>             |   |  |
| Type ... ..                | Flat top, with transfer port cutaways in base of skirt. Pegged, to retain piston rings                  |  |
| Oversizes available ... .. | + 0.010 in. (0.25 mm) and + 0.020 in. (0.50 mm)   |  |
| <b>Piston rings:</b>       |   |  |
| Type ... ..                | Two only, both compression. Profiled ends to locate with piston pegs, one chrome plated, one parkerized |  |
| End gap ... ..             | 0.006 in. (0.15 mm) - 0.014 in. (0.35 mm)   |  |

**Cylinder barrel:**

|               |   |
|---------------|---|
| Bore ... ..   | 40 mm   |
| Limits ... .. | Maximum permissible ovality 0.002 in. (0.05 mm) |

**Crankshaft:**

|             |   |
|-------------|---|
| Type ... .. | Steel, two bearing with caged roller big and small ends |
|-------------|---|

**Torque wrench settings:**

| Stud size (mm) | ft lb       | Stud size (mm) | ft lb       |
|----------------|-------------|----------------|-------------|
| 6              | 7.5         | 12             | 29.0 - 33.0 |
| 7              | 11.25       | 14             | 33.0 - 37.5 |
| 8              | 15.0        | 17             | 41.5 - 50.0 |
| 10             | 25.0 - 29.0 |                |             |

**Gear ratios:**

|               |       |
|---------------|-------|
| Top ... ..    | 1.038 |
| Third ... ..  | 1.304 |
| Second ... .. | 1.899 |
| Bottom ... .. | 3.077 |

**Clutch**

|                     |               |
|---------------------|---------------|
| Wet, multi disc     |               |
| Primary drive       | Gear          |
| Primary drive ratio | 3.895 (74/19) |
| Final drive         | Chain         |
| Final drive ratio   | 2.785 (39/14) |

**1 General description**

The engine fitted to the Yamaha FSI-E is of the two stroke type, with a rotary disc inlet valve, working on the 'loop scavenging' principle. A flat top piston is used, fitted with pegs to retain the piston rings in a set location so that they cannot rotate and permit the ends to become trapped and broken in the ports. Cutaways in the base of the piston skirt facilitate the opening and closing of the transfer ports.

Lubrication is effected by a petrol/oil mixture which must be premixed in the fuel tank in the recommended proportions of 20 parts of petrol to one part of oil. The system operates on the 'total loss' principle whereby all excess oil is expelled via the exhaust system. Because the two-stroke utilises crankcase compression before the incoming mixture is transferred to the cylinder for ignition, the big end, main bearings, small end and piston are fully lubricated by the oil content of the incoming charge.

The gearbox and clutch depend on separate lubrication and run in oil in a separate compartment of the crankcase assembly.

The engine and gearbox are of unit construction hence when the crankcases are split the crankshaft and gearbox internals are exposed.

**2 Operations with engine in frame**

It is not necessary to remove the engine unit from the frame unless the crankshaft assembly and/or the gearbox internals require attention. Most operations can be accomplished with the engine in place, such as removal and replacement of:

- 1 Cylinder head
- 2 Cylinder barrel and piston
- 3 Flywheel generator
- 4 Clutch assembly
- 5 Contact breaker assembly

When several operations need to be undertaken simultaneously, it will probably be advantageous to remove the complete engine unit from the frame, an operation that should take approximately fifty minutes. This will give the advantage of better access and more working space.

**3 Operations with engine removed**

- 1 Removal and replacement of the main bearings.
- 2 Removal and replacement of the crankshaft assembly.
- 3 Removal and replacement of the gear cluster, selectors and gearbox main bearings.

**4 Method of engine/gearbox removal**

As described previously, the engine and gearbox are built in unit and it is necessary to remove the unit complete in order to gain access to either component. Separation is accomplished after the engine unit has been removed and refitting cannot take place until the crankcases have been reassembled. When the crankcases are separated the gearbox internals will also be exposed.

**5 Removing the engine/gear unit**

- 1 Place the machine on the centre stand and make sure it is standing firmly on level ground.
- 2 Turn off the petrol tap.
- 3 Remove the side covers, the right hand one contains the tool kit, the left hand one exposes the battery.
- 4 Disconnect the battery and remove it from the machine.
- 5 Remove the cotter pin from the left hand pedal crank. The cotter pin may be very tight so care should be taken not to damage the thread.
- 6 Remove the three screws in the pedal chain cover and let it drop down the pedal crank.
- 7 Remove the circlip retaining the pedal drive sprocket and slide the sprocket and crank off together, followed by the spring and drive dog. Pull the other crank, with the spindle, from the right hand side of the machine.
- 8 Ensure that the machine is in neutral, then remove the gearchange lever bolt completely which will allow the lever to slide off its shaft.
- 9 Remove the four screws and the left hand cover to reveal the generator. It will lift away with the clutch cable attached. There is no need to separate the cable.
- 10 Disconnect the generator leads in the battery compartment.
- 11 Remove the final drive chain spring link and pull the chain off the engine sprocket.

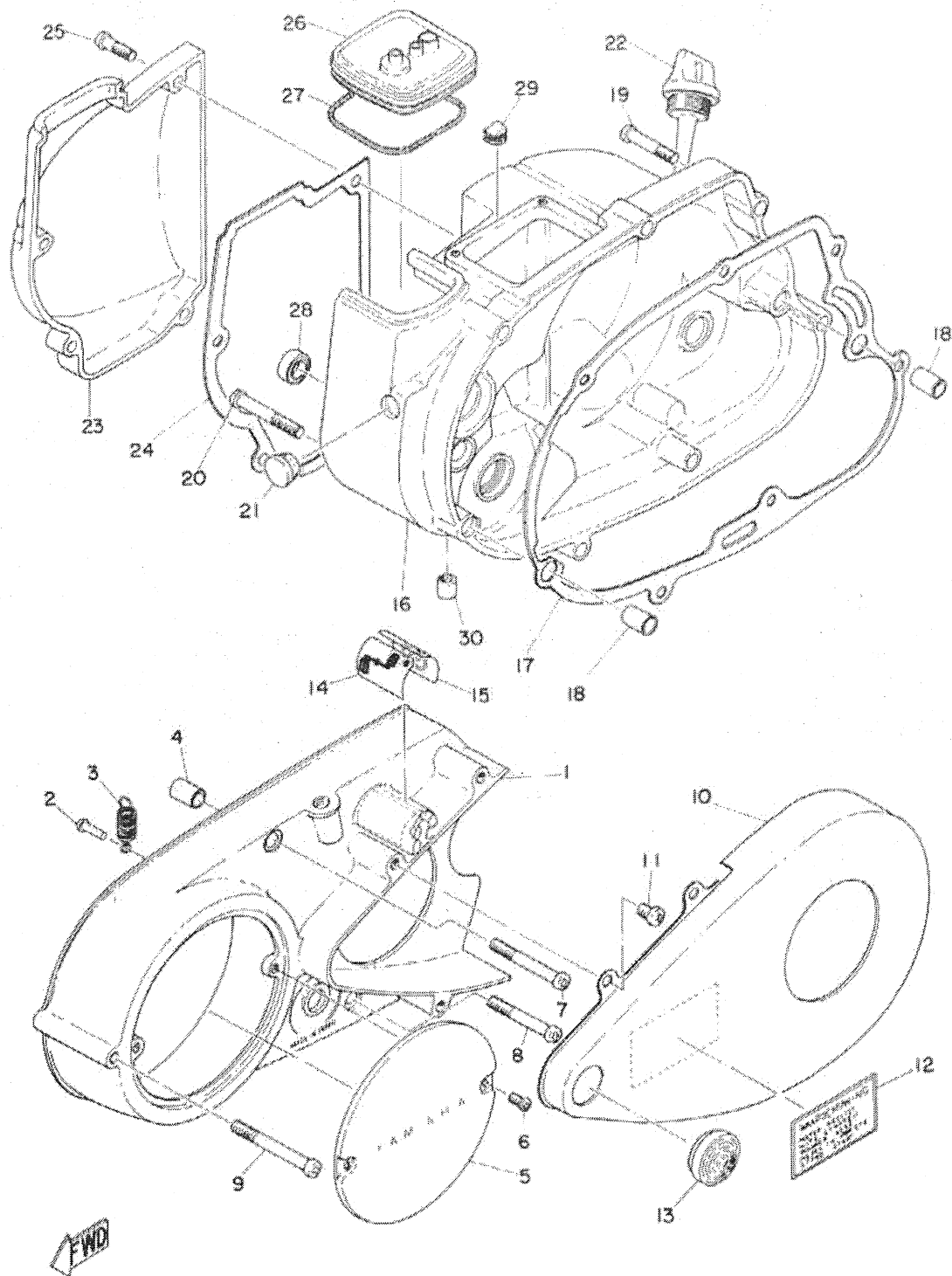

Fig. 1.1. Crankcase covers

- |  |  |   |  |
|--|--|---|--|
| 1 Left-hand crankcase cover                  | 8 Crankcase cover screw                  | 17 Gasket for right-hand cover                | 24 Gasket for carburettor cover                |
| 2 Spring hook                                | 9 Crankcase cover screw                  | 18 Dowel pin - 2 off                          | 25 Panhead screw for carburettor cover - 4 off |
| 3 Return spring (clutch operating arm)       | 10 Pedalling chain cover                 | 19 Panhead screw for right-hand cover - 6 off | 26 Boot for carburettor cover                  |
| 4 Dowel pin - 2 off                          | 11 Panhead screw for chain cover - 3 off | 20 Panhead screw for right-hand cover         | 27 Spring sealing band                         |
| 5 Generator cover                            | 12 Transfer for chain cover              | 21 Grommet plug                               | 28 Blind plug                                  |
| 6 Panhead screws for generator cover - 2 off | 13 Chain cover cap                       | 22 Oil level plug                             | 29 Grommet                                     |
| 7 Crankcase cover screw - 2 off              | 14 Instruction transfer 1                | 23 Carburettor cover                          | 30 Drain tube                                  |
|  | 15 Instruction transfer 2                |   |  |
|  | 16 Right-hand crankcase cover            |   |  |

12 From the right hand side of the machine, remove the air filter end caps and element.

13 Remove the four screws and right hand cover to reveal the carburettor.

14 Slide the rubber boot and spring retainer up the control cables and pull the petrol pipe off.

15 Remove the plastic bung from the front of the carburettor enclosure, insert a screwdriver in the hole and slacken off the carburettor clamp ring. Pull the carburettor off its stub and tie it up out of the way.

16 Remove the kickstarter bolt completely and take off the kickstarter lever.

17 Undo the exhaust ring nut and take off the swinging arm nut to release the silencer. Gently pull the exhaust system from the machine and allow the tension of the brake return spring to be relieved. Unhook the spring and the exhaust system can be taken clear.

18 Remove the two bolts holding the air cleaner case and move the case to enable the four screws holding the top cover to be removed. The air cleaner case and the top cover through which the fuel pipe passes can then also be tied up out of the way.

19 Remove the spark plug, plug cap and the rear brake light switch.

20 Remove the top engine mounting bolt and allow the engine the pivot on the bottom bolt so that it rests on the ground.

21 Remove the bottom engine bolt and pull the engine clear of the machine.

#### 5 Dismantling the engine, clutch and gearbox - general

1 Before commencing work on the engine unit, the external surfaces should be cleaned thoroughly. A motorcycle engine has very little protection from road grit and other foreign matter, which will find its way into the dismantled engine if this simple precaution is not observed. One of the proprietary cleaning compounds such as Gunk can be used to good effect, particularly if the compound is allowed to work into the film of oil and grease before it is washed away. When washing down, make sure that water cannot enter the carburettor or the electrical system, particularly if these parts have been exposed.

2 Never use undue force to remove any stubborn part, unless mention is made of this requirement. There is invariably good reason why a part is difficult to remove, often because the dismantling operation has been lacked in the wrong sequence. Dismantling will be made easier if a simple engine stand is constructed that will correspond with the engine mounting points. This arrangement will permit the complete unit to be clamped rigidly to the workbench, leaving both hands free.



5.4 Disconnect battery and remove from machine

#### 7 Generator - removal

**Engine in the frame as only the generator has to be removed**

As it is possible to remove the generator whilst the engine is still in the frame, only the first ten paragraphs of Section 5 need to be followed before proceeding with the following dismantling procedure.

**Engine removed from the frame**

If the whole of Section 5 has been completed continue with the following dismantling procedure:

- 1 Remove the rotor nut and washer.
- 2 Use the special extractor tool to remove the rotor as it is a keyed taper fit. If the extractor is not available wind some emery cloth round the rotor, place a piece of chain (the pedalling chain was found useful) round it and use a nut and bolt through the chain links to clamp the chain tight on top of the emery cloth. A sprocket puller can now be used to remove the rotor as shown in the accompanying photograph.
- 3 Remove the two screws and the stator plate, disconnect the wire to the neutral warning light switch.
- 4 If further dismantling is required prise out the Woodruff key.

#### 8 Dismantling the engine unit - removing the cylinder head and cylinder barrel and piston

- 1 Unscrew the four nuts which retain the cylinder head in position and remove them together with their washers. The cylinder head can now be lifted off the holding down studs.
- 2 Slide the cylinder barrel up the holding down studs, taking care to support the piston when it falls clear of the cylinder bore. If only a limited amount of dismantling is being undertaken, it is advisable to pad the crankcase mouth with clean rag as soon as the cylinder barrel is raised, otherwise particles of broken piston ring may fall into the crankcase and necessitate further dismantling to retrieve them.
- 3 Remove the two circlips from the piston, using a pair of long nosed pliers. The gudgeon pin can now be pushed out of position, allowing the piston complete with rings to be removed from the connecting rod.
- 4 If the gudgeon pin is a tight fit, warm the piston by placing a rag soaked in hot water on the crown. Never drift the gudgeon pin out of position without supporting the piston, otherwise there is risk of bending the connecting rod. Throw away the circlips: they should never be re-used.

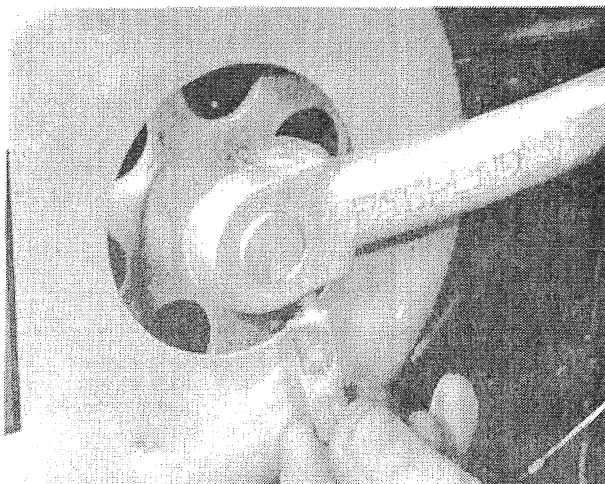

5.5 Drive cotter pin from left-hand pedal crank



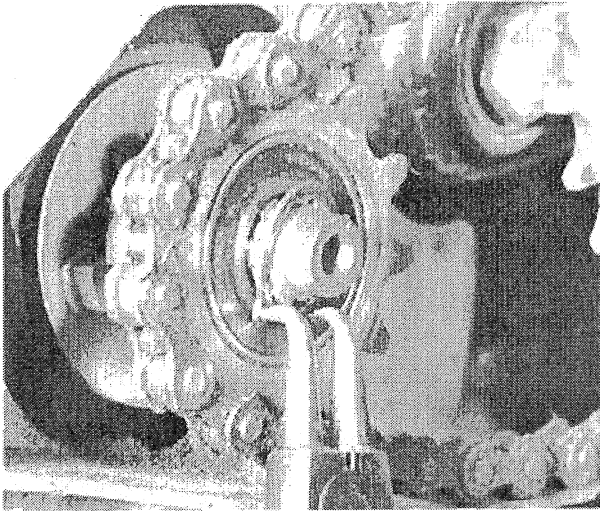

5.7a Circlip retains pedal drive sprocket

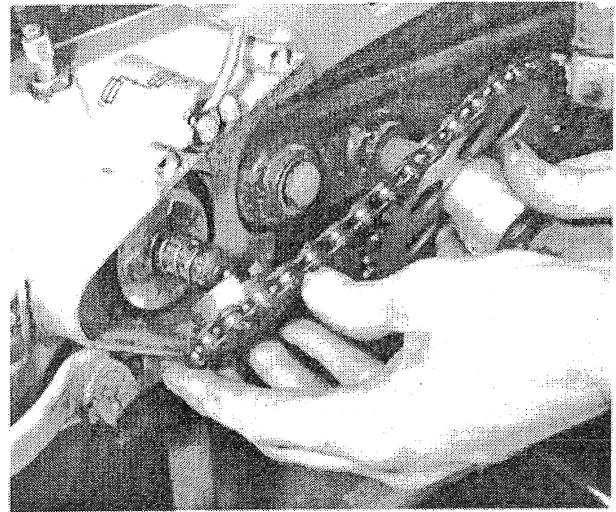

5.7b Lift off pedal crank, sprocket and chain in unison

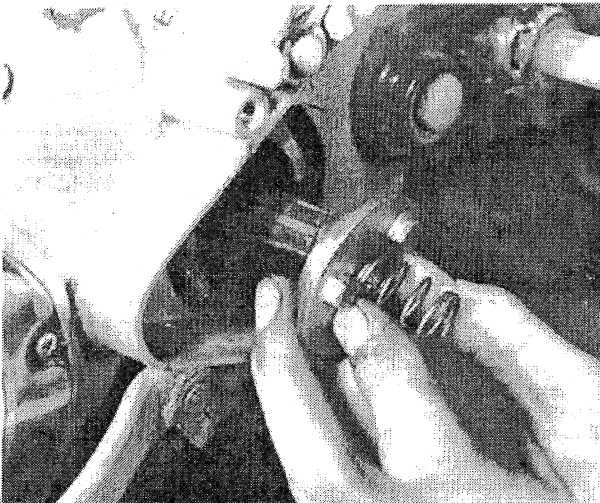

5.7c Follow by lifting off spring and drive dog

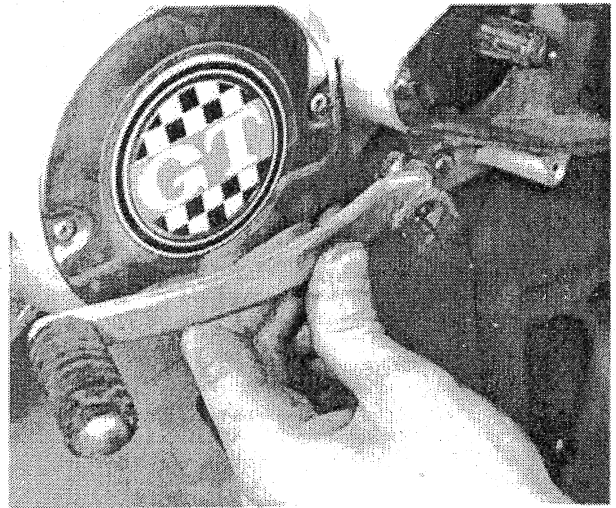

5.8 Remove bolt completely to withdraw gear change lever

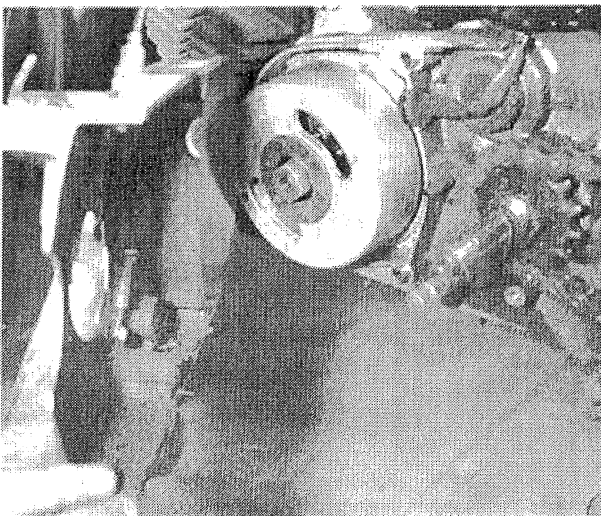

5.9 Generator cover is retained by four screws

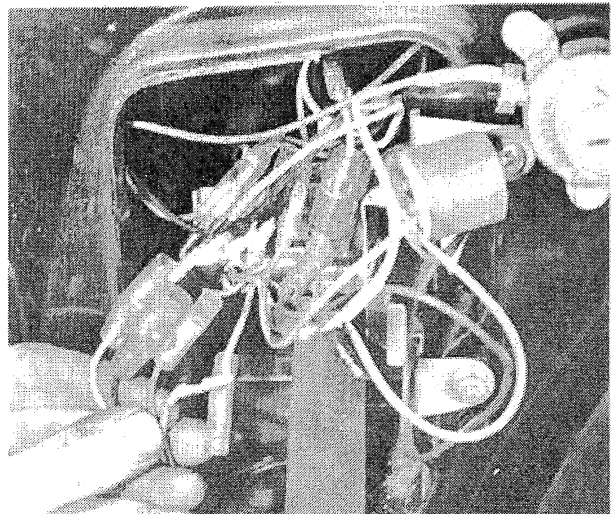

5.10 Generator leads are colour coded to make reconnection easy

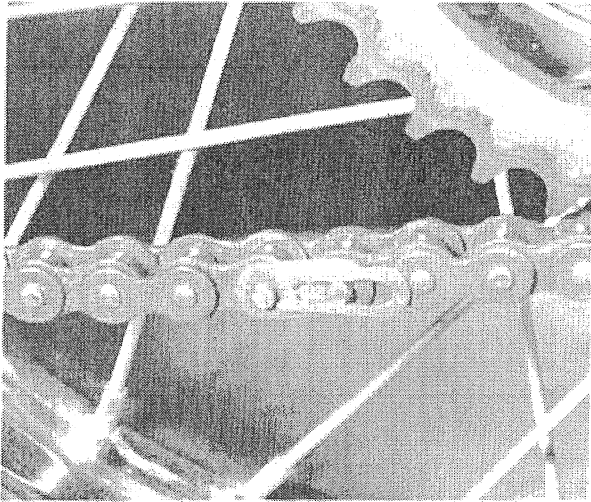

5.11 Remove spring link to separate final drive chain

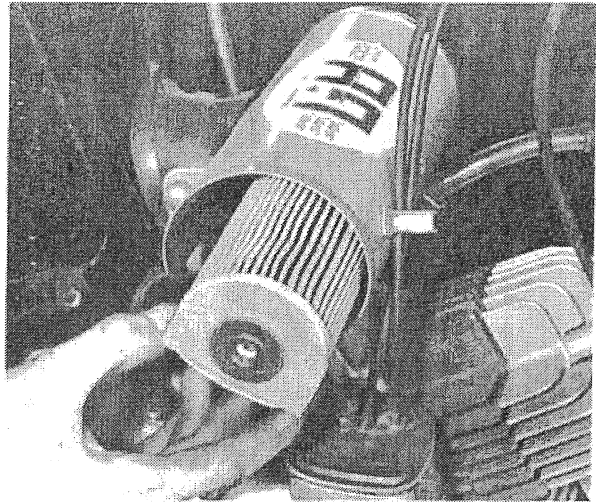

5.12 Air cleaner element pulls out of casing

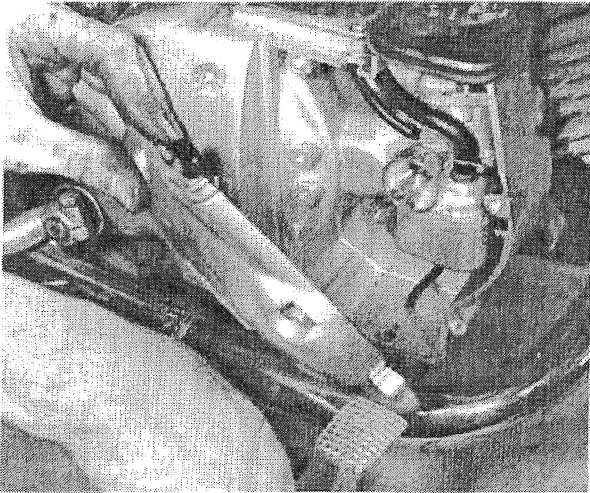

5.13 Remove right-hand cover for access to carburettor

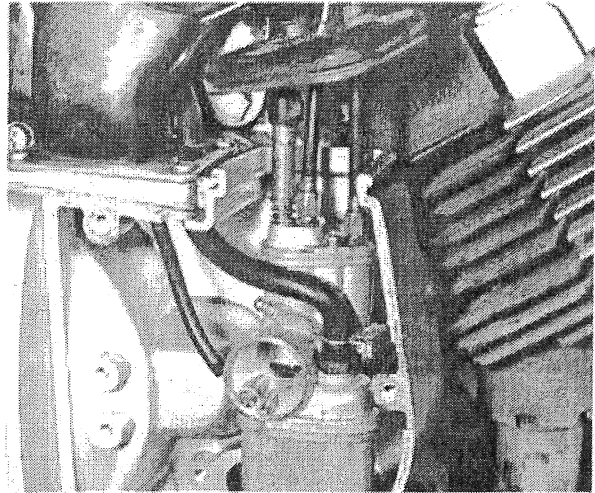

5.14 Raise rubber boot and lift off petrol feed pipe

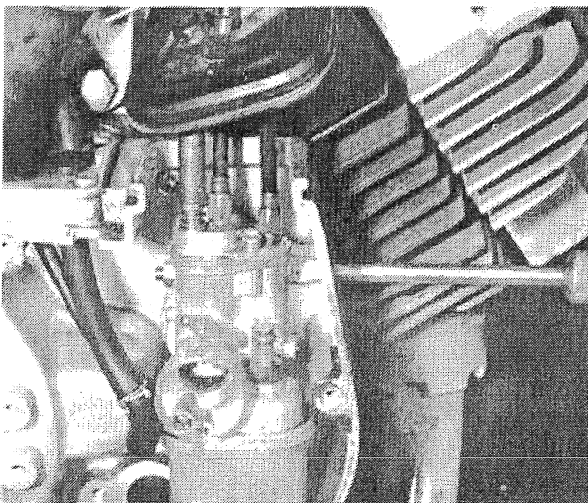

5.15a Access to carburettor clamp is through hole in cover

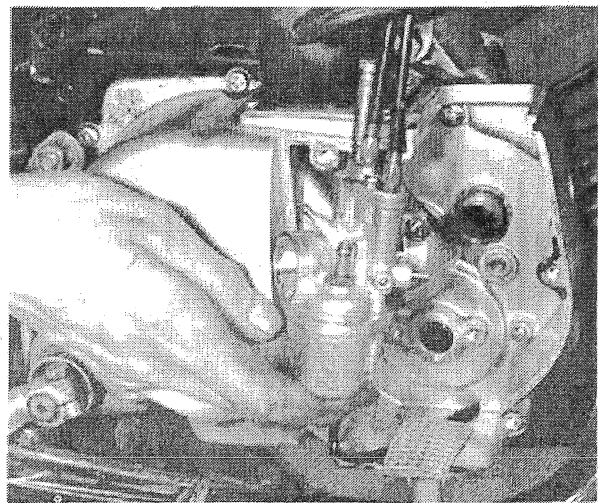

5.15b Carburettor will pull off inlet stub

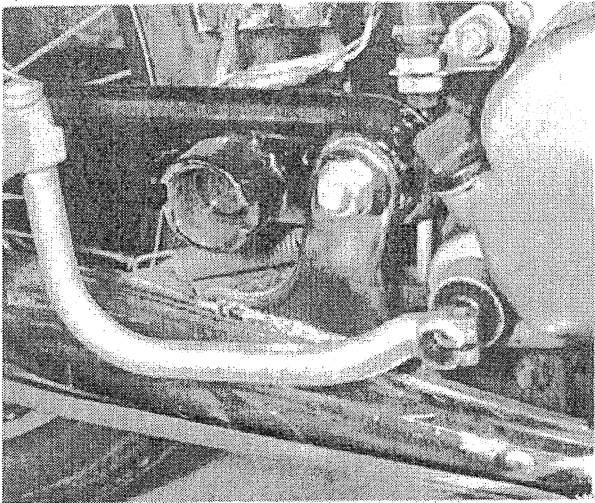

5.16 Remove kickstarter bolt completely to free crank

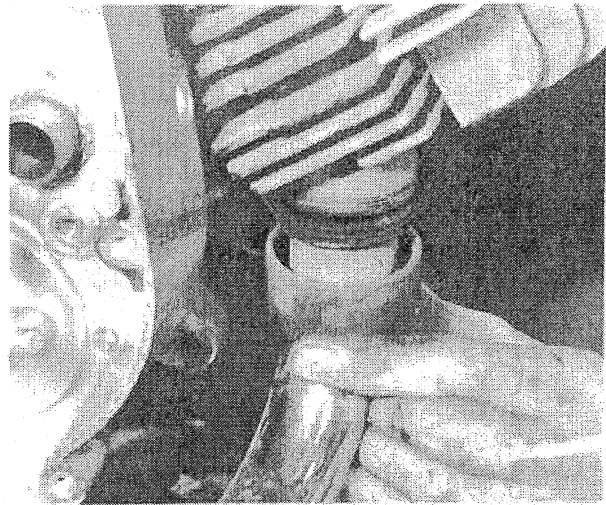

5.17 Unscrew exhaust pipe ring nut

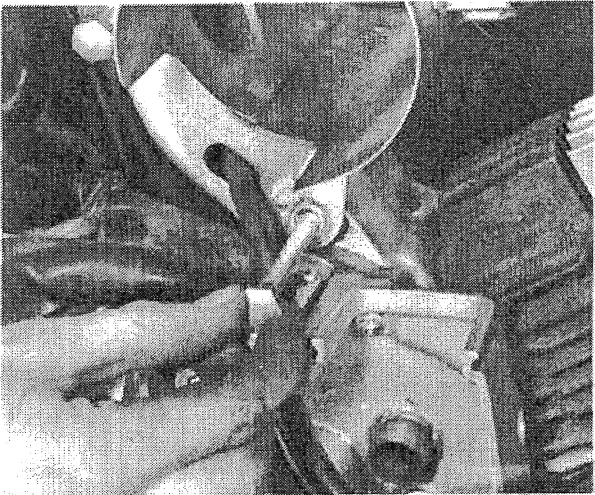

5.18a Two bolts retain air cleaner case to engine and frame

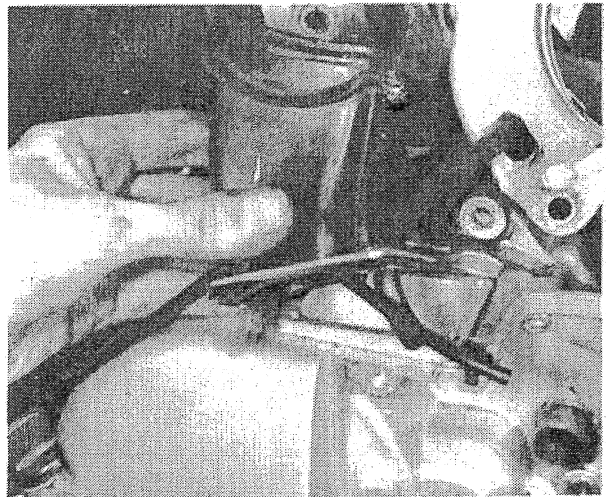

5.18b Four bolts retain top cover to carburettor compartment

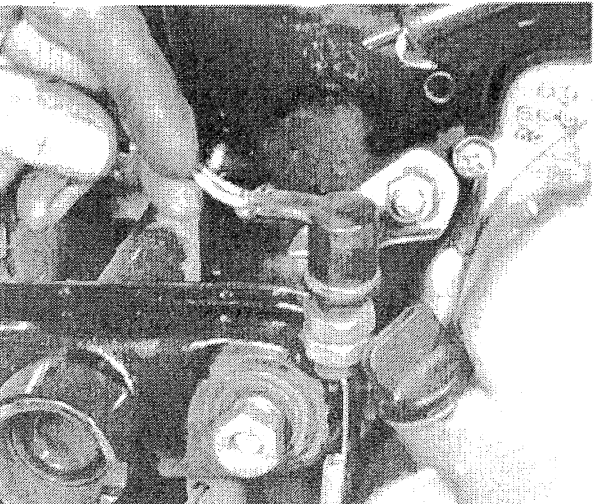

5.19 Unhook spring and remove stop lamp switch

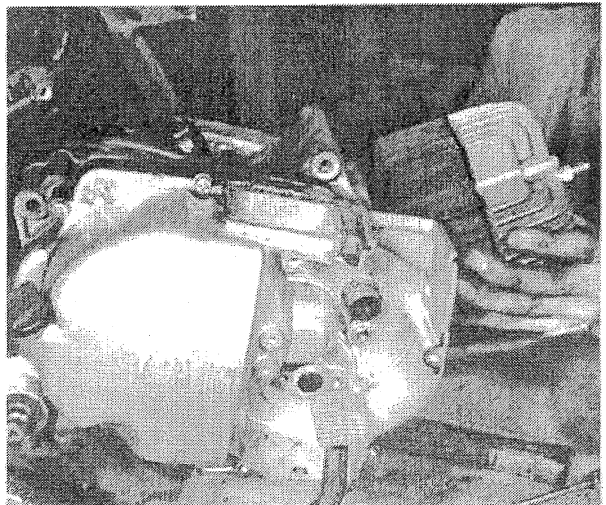

5.20 Removal of top engine bolt allows engine unit to pivot downwards

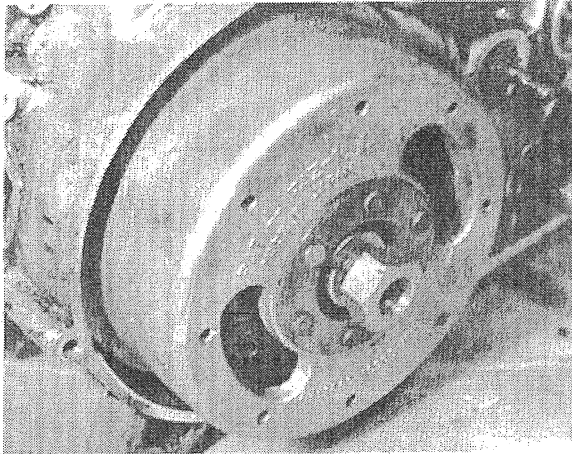

7.1 Lock engine to remove nut and washer

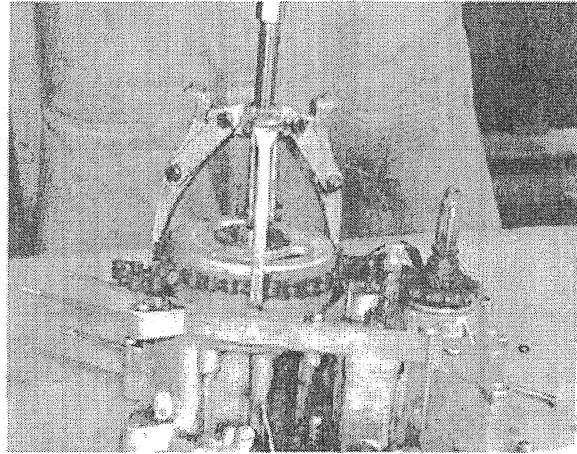

7.2 Improved means of removing the rotor without the service tool

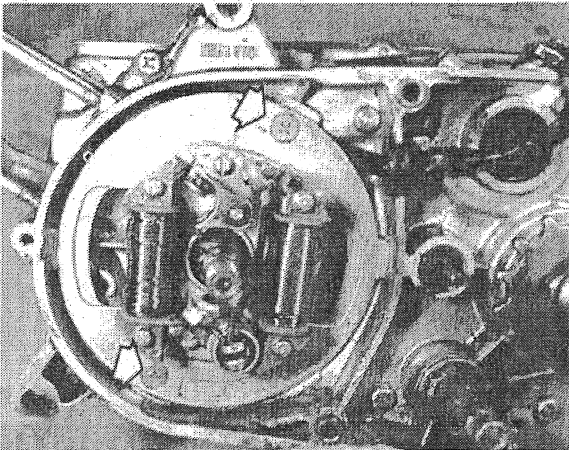

7.3 Stator plate is retained by two cross head screws

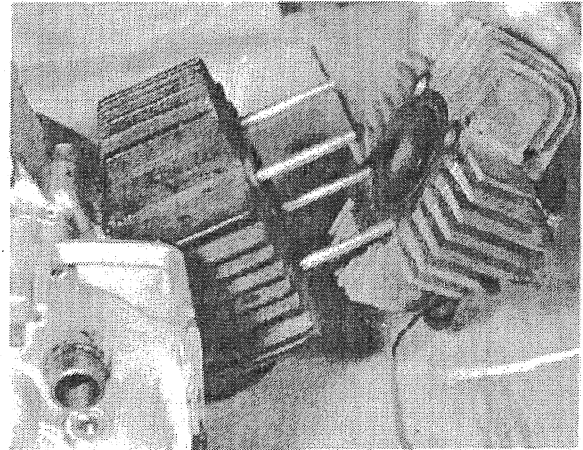

8.1 Cylinder head is retained by four nuts

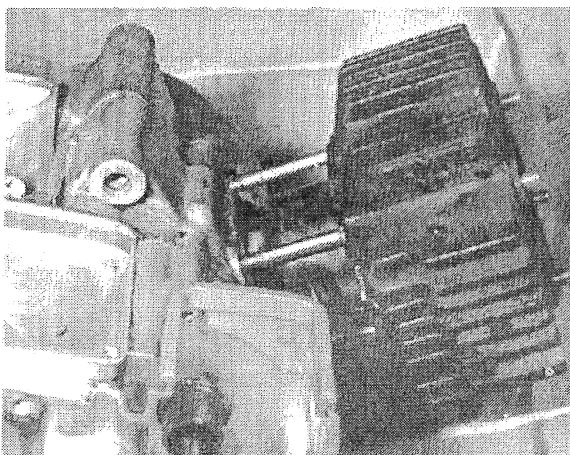

8.2 Cylinder barrel will slide up holding down studs

5 Note that the piston crown is marked with an arrow and when reassembling the piston this arrow should point down (toward the exhaust port).

6 The small end is a caged roller assembly and will slide easily out of the connecting rod.

#### 9 Dismantling the engine unit - final drive sprocket removal

- 1 Remove the circlip on the gearbox mainshaft.
- 2 Prise the tab washer away from the nut, lock the sprocket and loosen the nut.
- 3 Remove the two half collets and the screwed sleeve and nut will slide off.
- 4 The tab washer and sprocket can then be removed.

#### 10 Dismantling the engine unit - clutch dismantling and removal

- 1 Drain the engine oil.
- 2 Remove the seven screws holding the right hand cover, noting that the long one is fitted by the carburettor stub.
- 3 Remove the cover with the engine over a small tray to catch the oil left in the engine. Note that there are two O rings, one on the carburettor stub and one adjacent to it which may stick to the cover; these should be removed to avoid loss or damage.

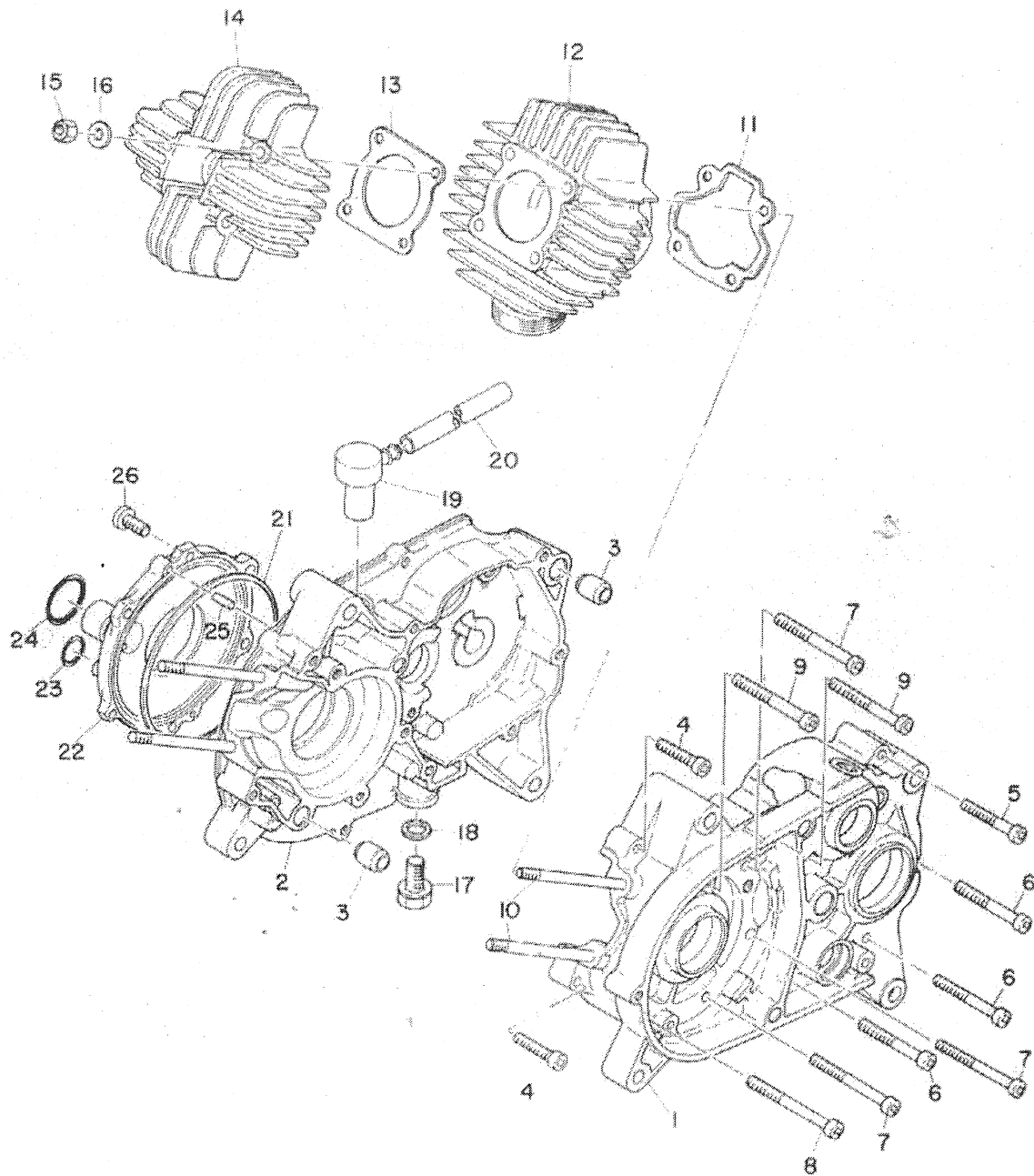
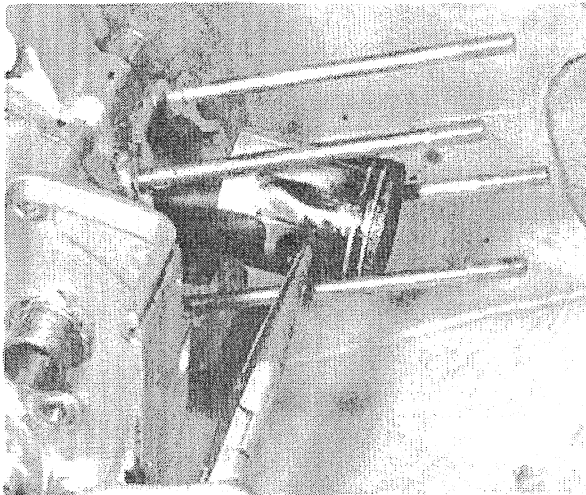
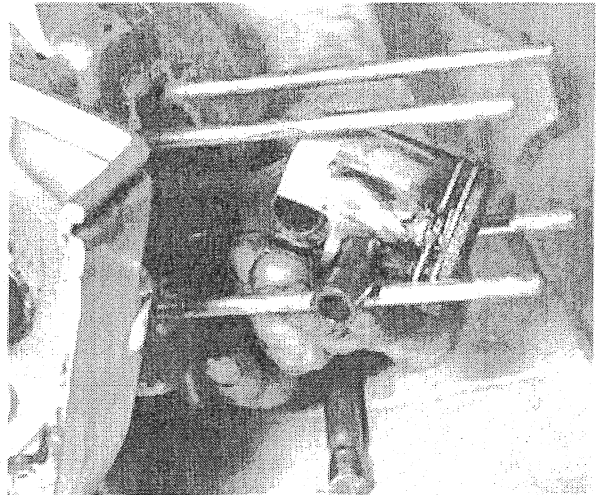

Fig. 1.2. Crankcase and cylinder assembly

- |   |   |                              |   |
|---|---|------------------------------|---|
| 1 Left-hand crankcase                           | 7 Panhead screw for left-hand crankcase - 3 off | 12 Cylinder barrel           | 21 'O' ring seal for disc valve cover         |
| 2 Right-hand crankcase                          | 8 Panhead screw for left-hand crankcase         | 13 Cylinder head gasket      | 22 Disc valve cover                           |
| 3 Dowel pin - 2 off                             | 9 Panhead screw for left-hand crankcase - 2 off | 14 Cylinder head             | 23 'O' ring seal                              |
| 4 Panhead screw for left-hand crankcase - 2 off | 10 Cylinder holding down stud - 4 off           | 15 Cylinder head nut - 4 off | 24 'O' ring seal for carburettor stub         |
| 5 Panhead screw for left-hand crankcase         | 11 Cylinder base gasket                         | 16 Plain washer - 4 off      | 25 Dowel pin - 2 off                          |
| 6 Panhead screw for left-hand crankcase - 3 off |   | 17 Drain plug                | 26 Panhead screw for disc valve cover - 6 off |
|   |   | 18 Drain plug washer         |   |
|   |   | 19 Breather assembly         |   |
|   |   | 20 Breather pipe             |   |



8.3 Long nose pliers aid removal of circlips



8.4 Heat piston if gudgeon pin is a tight fit

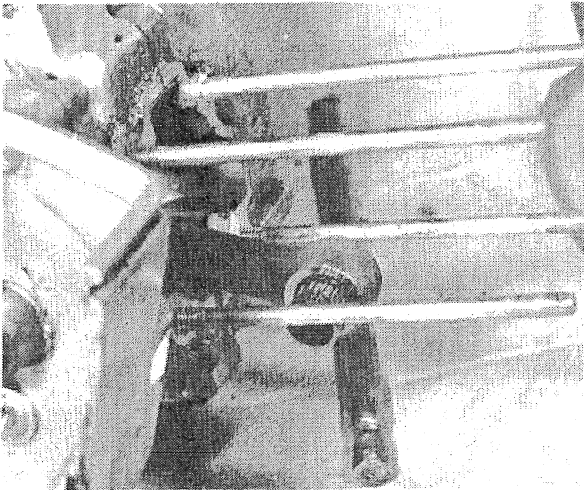

8.6 Small end bearing is a caged needle roller assembly

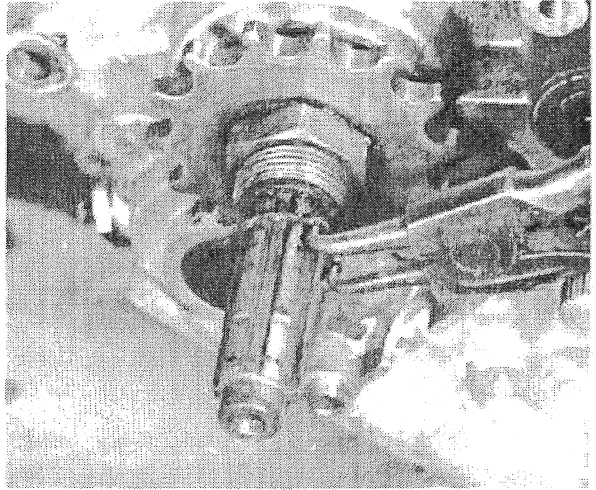

9.1 Remove circlip from gearbox mainshaft

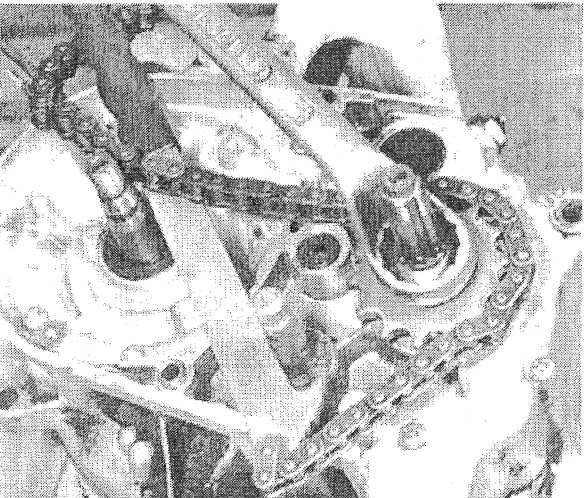

9.2 Use of chain wrench to lock sprocket whilst slackening nut

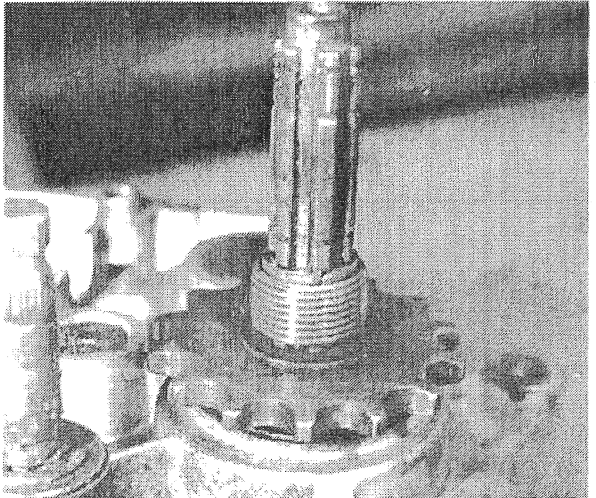

9.3a Remove two collets and screwed sleeve to free sprocket ...

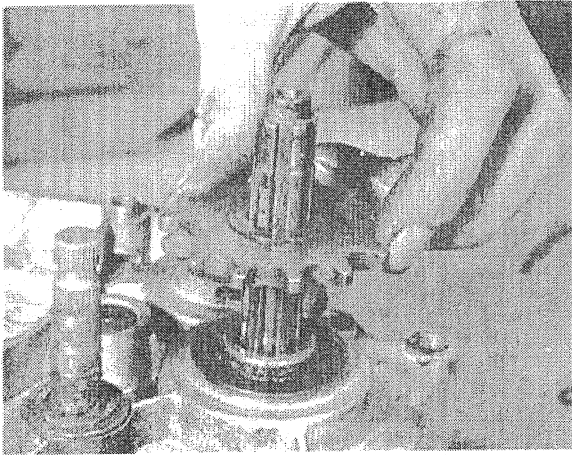

9.3b ... which will then lift off mainshaft

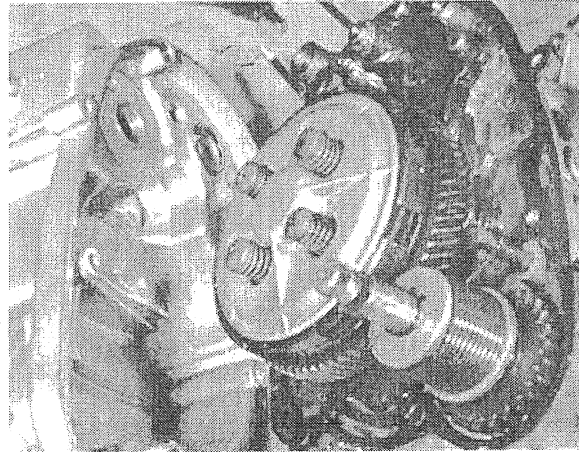

10.2 Right-hand cover is retained by seven screws

4 Remove the four screws and clutch pressure springs. The clutch pressure plate can then be removed to expose the pushrod.

5 The pushrod is in two pieces with a very small ball bearing between them so after pulling out the first pushrod, tip the engine and catch the small ball as it rolls out. The second pushrod can be pulled out from the opposite side.

6 Remove the three clutch plates, one aluminium, two fibre.

7 Prise the tab washer away from the clutch centre nut, lock the clutch centre with a suitable piece of shaped metal and undo the nut.

8 The tab washer and clutch centre can then be removed, followed by a thrust washer.

9 The clutch drum can then be pulled off with a slight clockwise turn to free the helical gears.

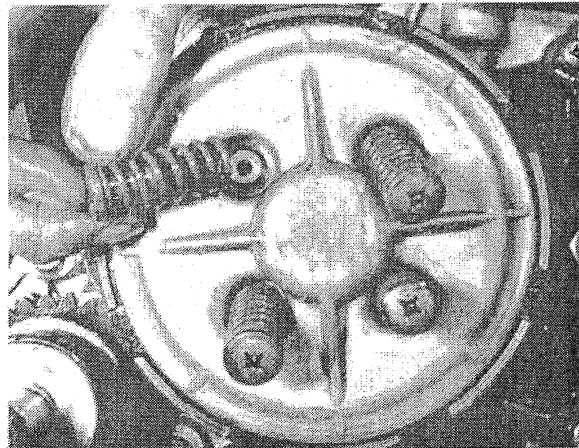

10.4a Remove the four screws and springs to free pressure plate

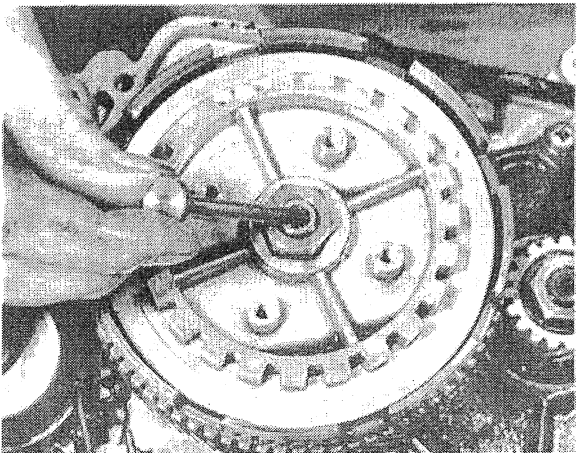

10.4b Lift out first portion of clutch push rod

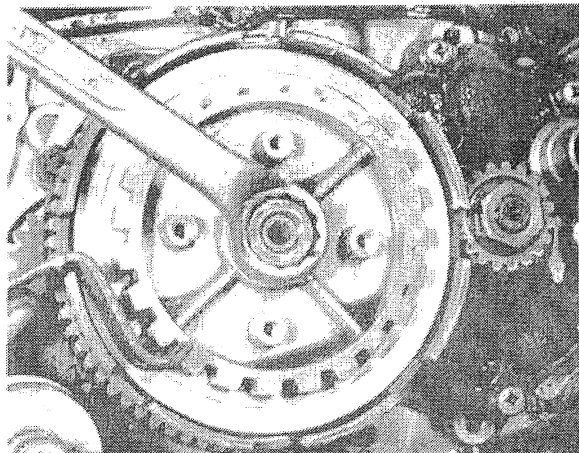

10.7 Use piece of shaped metal to lock clutch centre whilst slackening nut

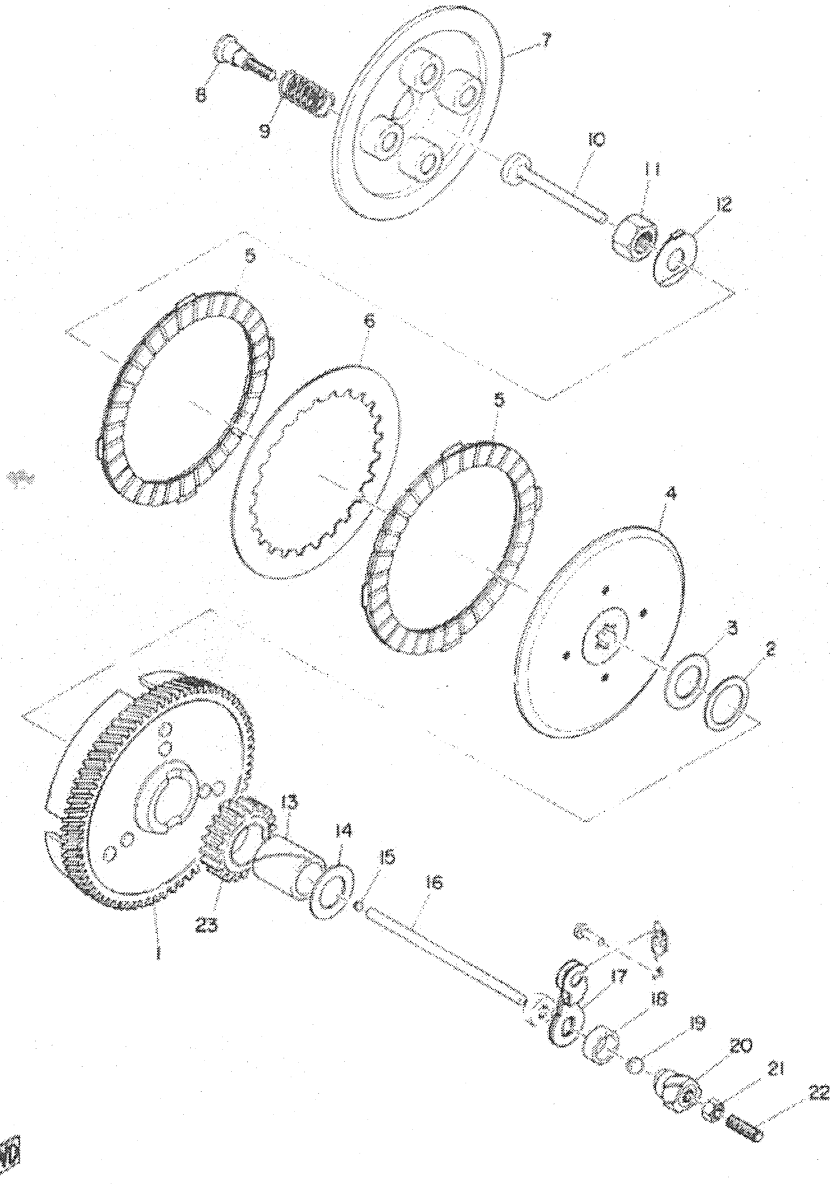
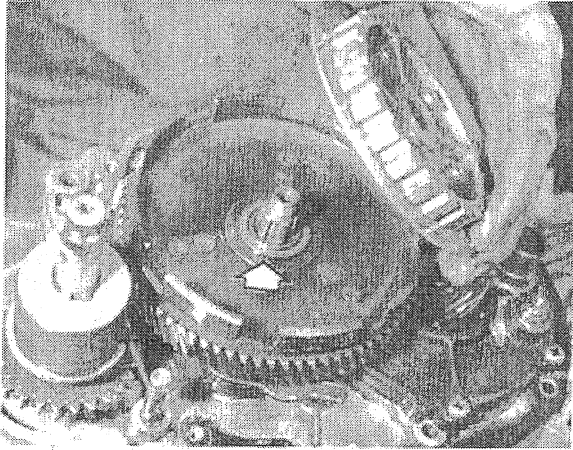

Fig. 1.3. Clutch

- |                                |                                |                             |                          |
|--------------------------------|--------------------------------|-----------------------------|--------------------------|
| 1 Primary driven gear complete | 6 Plain plate                  | 12 Tab washer               | 18 Oil seal              |
| 2 Thrust washer                | 7 Pressure plate               | 13 Spacer                   | 19 Ball bearing (N inch) |
| 3 Thrust plate                 | 8 Clutch spring screw - 4 off  | 14 Thrust plate             | 20 Quick thread worm     |
| 4 Clutch centre                | 9 Clutch spring - 4 off        | 15 Ball bearing (3/16 inch) | 21 Adjuster nut          |
| 5 Friction plate - 2 off       | 10 Push rod 1                  | 16 Push rod 2               | 22 Adjusting screw       |
|                                | 11 Clutch centre retaining nut | 17 Actuating lever          | 23 Kickstarter pinion    |





10.8 Note thrust washer behind clutch centre

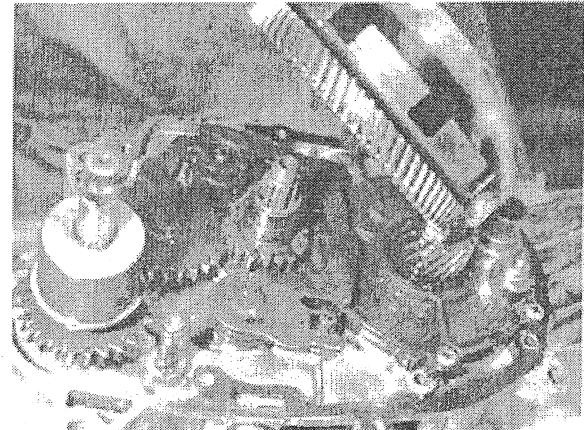

10.9 Lift off with clockwise twist to disengage helical gears

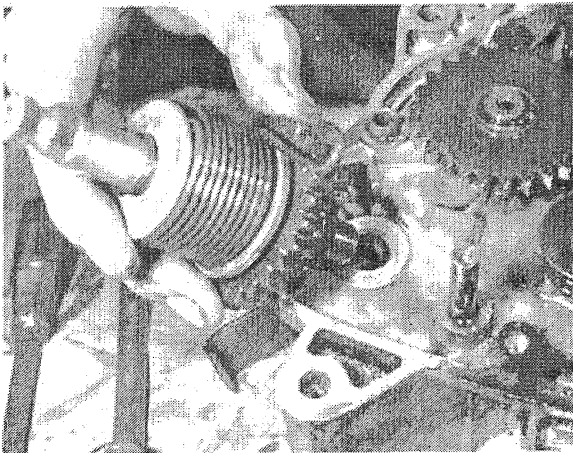

11.1 Unhook kickstarter return spring and pull assembly from crankcase

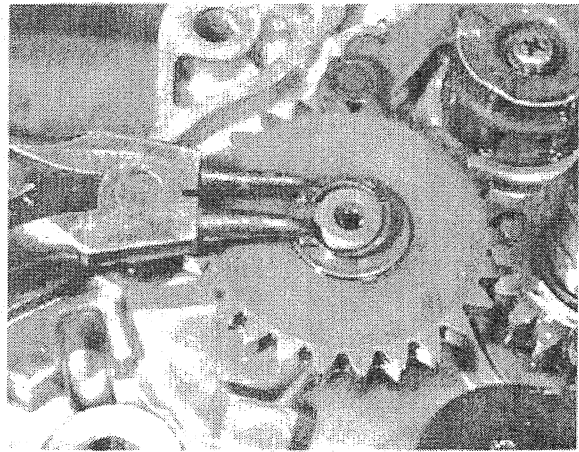

11.2 Circlip retains idler pinion

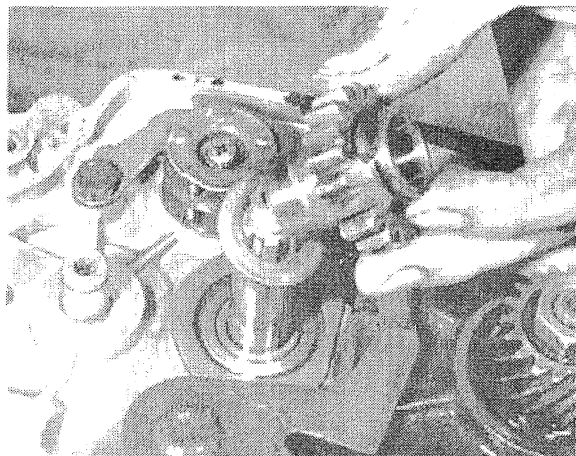

11.3 Clutch pinion and sleeve assembly will then lift off

#### 11 Dismantling the engine - kickstarter mechanism

- 1 When the clutch has been removed the kickstarter shaft assembly can be pulled from the crankcases, when the spring has been unhooked.
- 2 Remove the circlip holding the idler pinion and pull off the plain washer, the pinion, the crinkle washer and a plain washer.
- 3 The clutch gear, sleeve and thrust washer can then be taken off.
- 4 To change the kickstarter return spring, remove the circlip and slotted spring register collar. The spring can then be removed from the shaft.

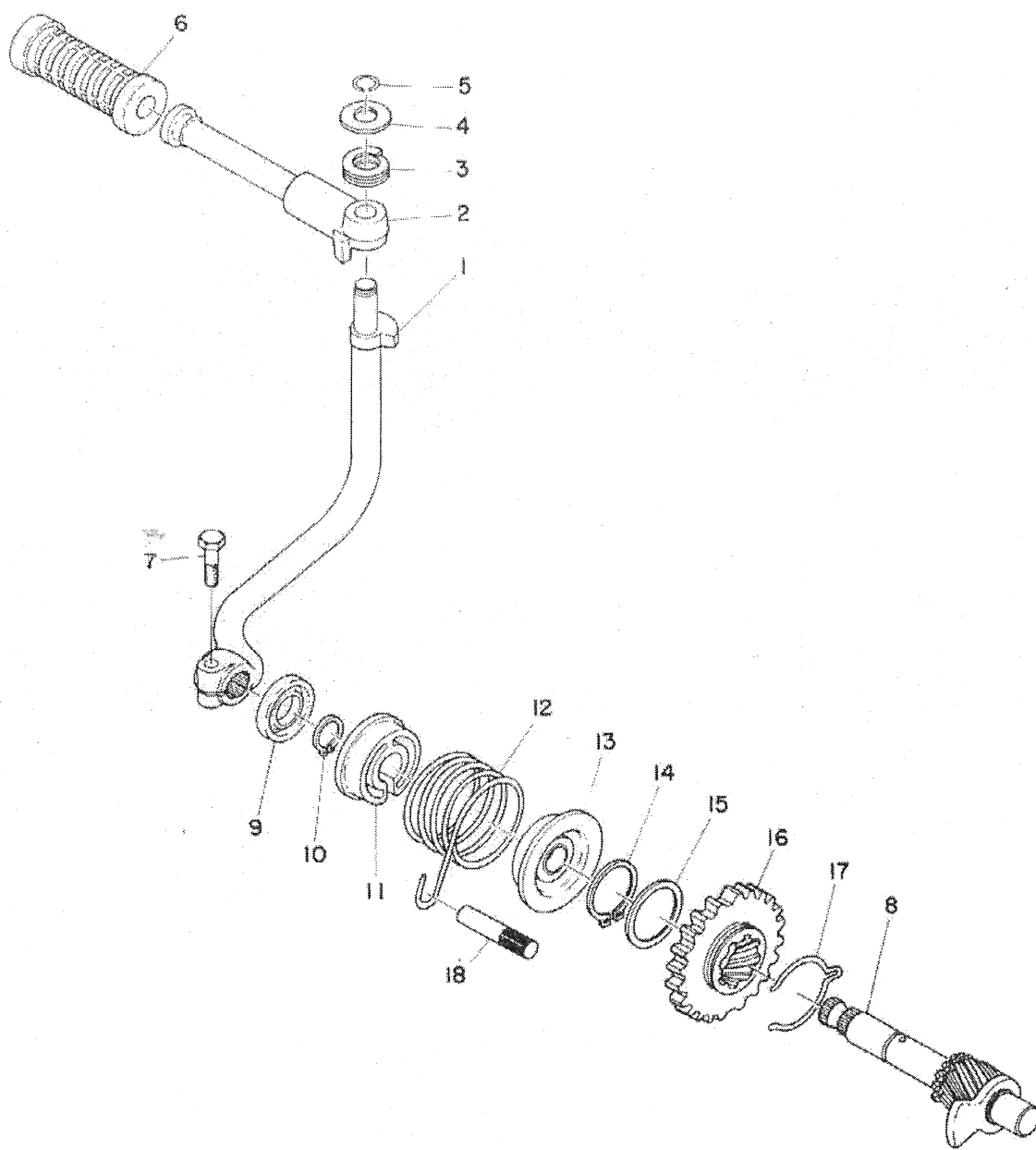
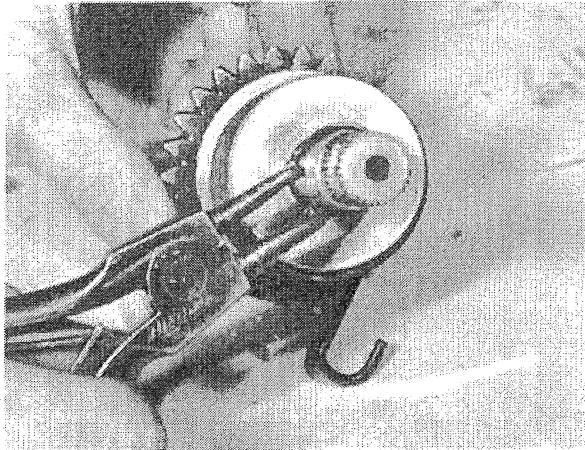
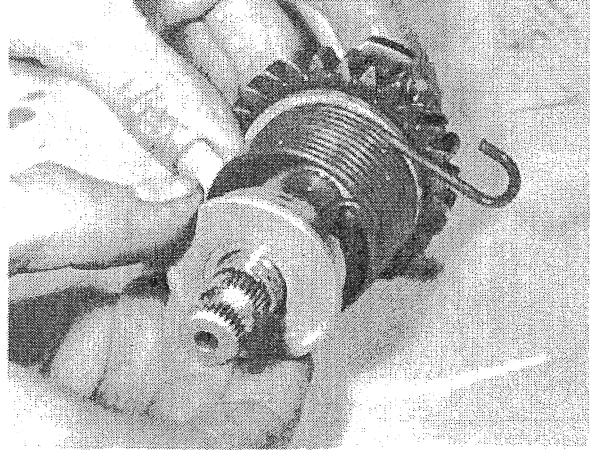

Fig. 1.4. Kickstarter assembly

- |                            |                                |                              |                              |
|----------------------------|--------------------------------|------------------------------|------------------------------|
| 1 Kickstarter crank        | 6 Kickstarter lever rubber     | 11 Kickstarter return        | 14 Circlip                   |
| 2 Kickstarter lever        | 7 Bolt for kickstarter crank   | spring collar                | 15 Shim                      |
| 3 Kickstarter crank spring | 8 Kickstarter spindle assembly | 12 Kickstarter return spring | 16 Kickstarter drive pinion  |
| 4 Kickstarter lever washer | 9 Oil seal                     | 13 Kickstarter return        | (26 teeth)                   |
| 5 Kickstarter lever clip   | 10 Circlip                     | spring guide                 | 17 Kickstarter assembly clip |
|                            |                                |                              | 18 Kickstarter spring anchor |



11.4a Remove circlip, followed by ...



11.4b ... the slotted spring register collar

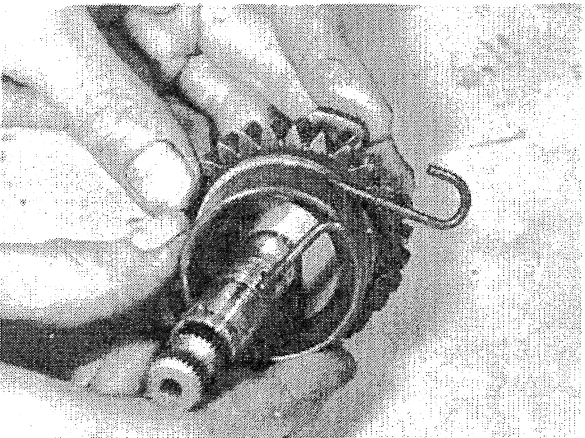

11.4c End of spring engages with hole in spindle ...

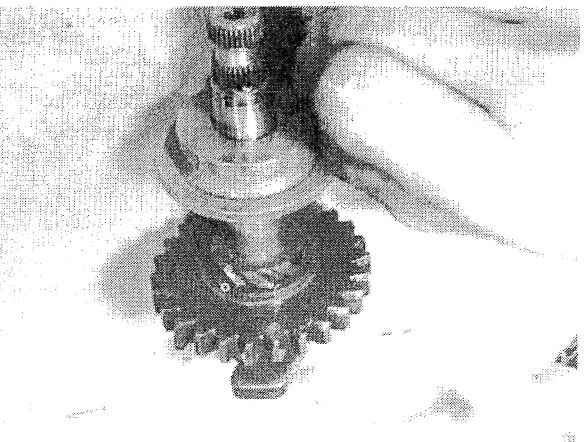

11.4d ... seats on another shouldered collar

## 12 Dismantling the engine - gearchange mechanism and index arm

- 1 When the clutch has been removed, the circlip and washer on the gearchange shaft on the other side of the engine has to be removed, which, after the pawl arm has been lifted clear of the gearchange cam, will allow the shaft assembly to be withdrawn. The pawl spring and the gearchange return spring should be checked and renewed if necessary.
- 2 Remove the shouldered bolt holding the index arm and unhook the spring which allows the arm to be removed.

## 13 Dismantling the engine - disc valve removal

- 1 When the gearchange mechanism has been removed, the mainshaft nut and belleville washer are taken off which allows the helical gear and spacer to be slid off its splines. Lock the engine to aid removal by inserting a metal rod through the eye of the connecting rod, so that it rests across the crankcase mouth.
- 2 Undo the six screws and remove the cover plate to expose the valve disc. Note that the pin on the mainshaft is in line with two indentations on the disc and must be lined up for reassembly.
- 3 Carefully remove the disc as it is made of fibre and is easily broken. Care should be taken when cleaning the disc as some cleaning fluids can destroy the disc. Wiping with a clean rag is the best recommendation.
- 4 The drive collar can then be slid off the crankshaft and the pin in the crankshaft pulled or tapped out.

## 14 Dismantling the engine - separating the crankcases

- 1 There are twelve screws holding the crankcase halves together. There are six different lengths of screw so a note should be made as to which screw fits in which hole.
- 2 Before trying to separate the crankcases, ensure that the valve disc pin and the rotor Woodruff key have been removed.
- 3 The right hand crankcase should lift off but light tapping with a rawhide mallet may be necessary.
- 4 Never use the point of a screwdriver to aid the separation of the crankcases. A leaktight crankcase is an essential requirement of any two-stroke engine. If the crankcase joint is damaged in any way, air will be admitted, which will dilute the incoming mixture whilst it is under crankcase compression. This will cause poor starting and indifferent running, mainly due to the weakened mixture that results.
- 5 Note that there are two locating dowels fitted in the crankcases.

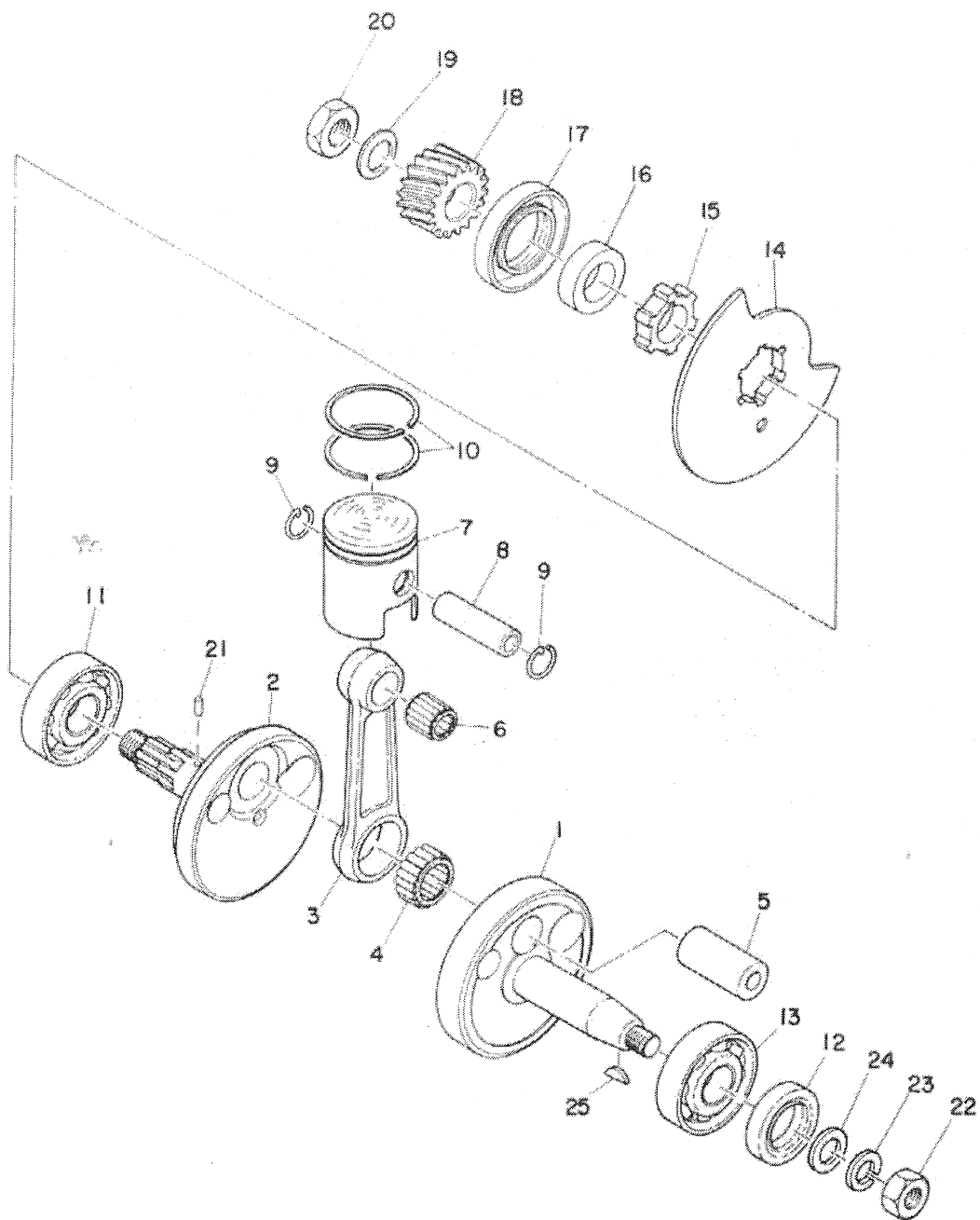
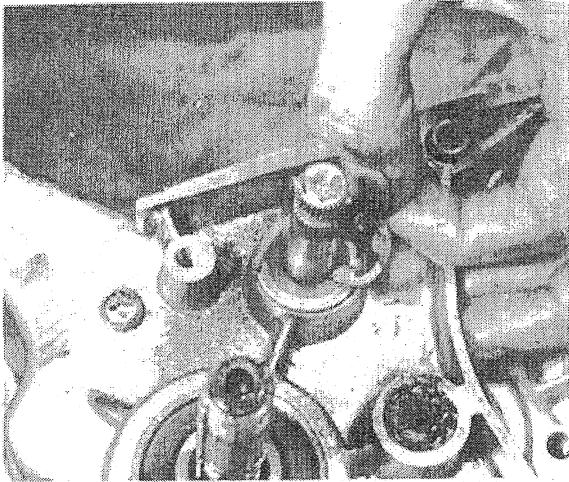
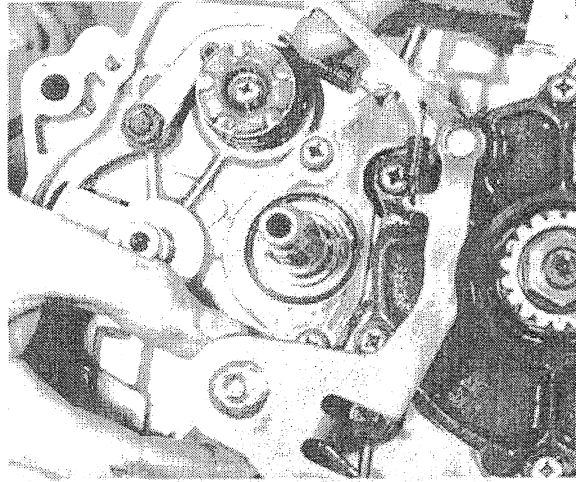

Fig. 1.5. Crankshaft, piston and disc valve

- |                     |   |                           |                        |
|---------------------|---|---------------------------|------------------------|
| 1 Left-hand crank   | 7 Piston (standard and two oversizes available) | 13 Left-hand main bearing | 20 Pinion securing nut |
| 2 Right-hand crank  | 8 Gudgeon pin                                   | 14 Disc valve             | 21 Dowel pin           |
| 3 Connecting rod    | 9 Circlip - 2 off                               | 15 Disc valve collar      | 22 Nut                 |
| 4 Big end bearing   | 10 Piston ring set                              | 16 Distance piece         | 23 Spring washer       |
| 5 Crankpin          | 11 Right-hand main bearing                      | 17 Right-hand oil seal    | 24 Plain washer        |
| 6 Small end bearing | 12 Left-hand oil seal                           | 18 Primary drive pinion   | 25 Woodruff key        |
|                     |   | 19 Belleville washer      |                        |



12.1a Remove the circlip and washer from the gear change shaft



12.1b Lift pawl from gear change cam and withdraw shaft assembly

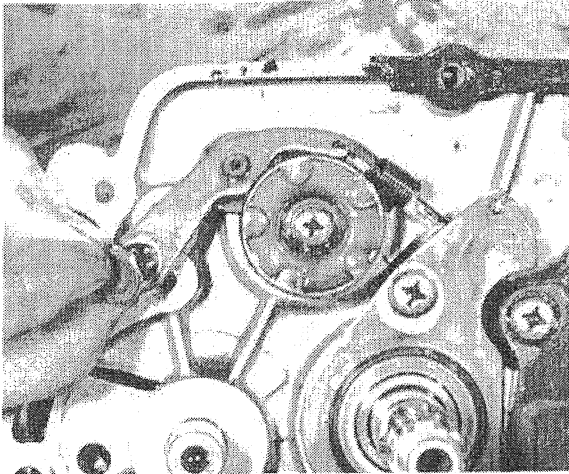

12.2 Remove shouldered bolt to release indexing arm and spring

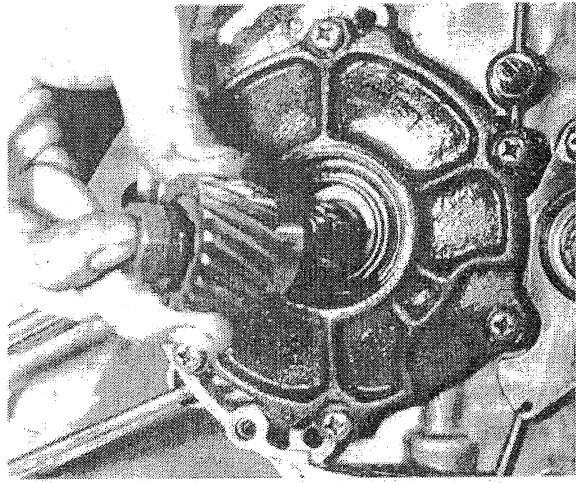

13.1 Lock engine again to remove crankshaft nut and drive pinion

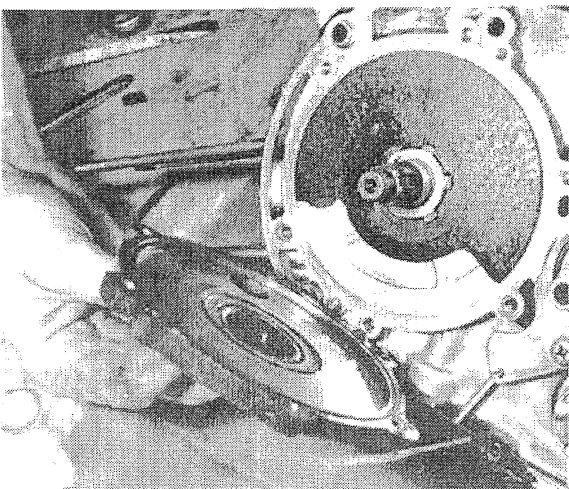

13.2 Remove cover plate to expose disc valve

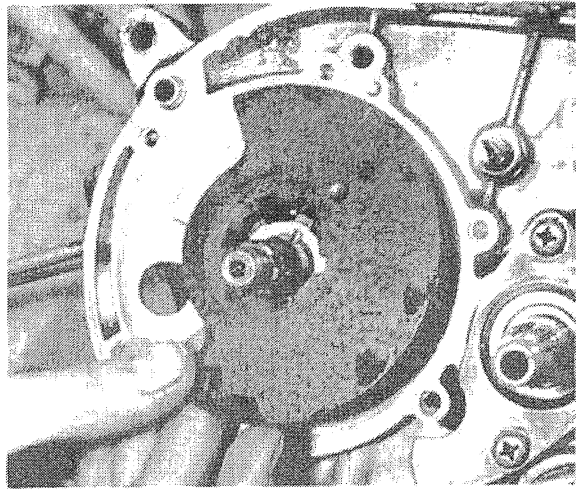

13.3 Ease disc out with care

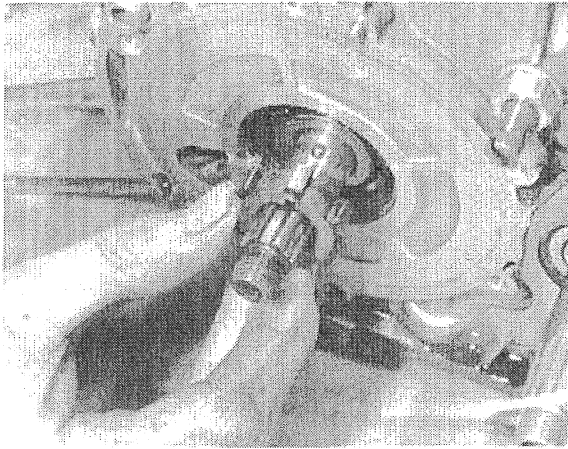

13.4 Drive collar will slide off crankshaft

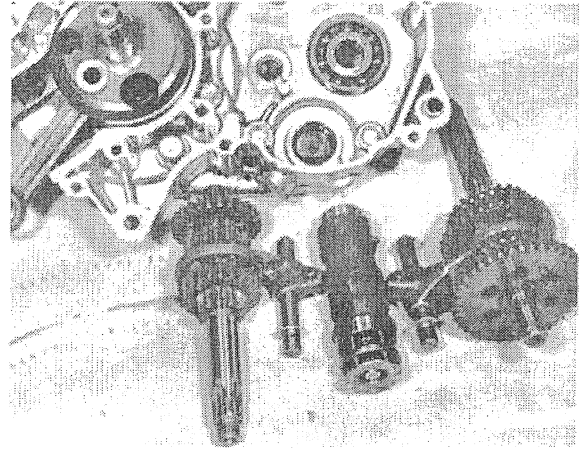

15.2 The gearbox components after separating the crankcases

#### 15 Dismantling the engine - removing the gearbox components

- 1 Remove the neutral indicator switch.
- 2 The gearbox shafts and selectors will slide out of the crankcase as a cluster but if difficulty is experienced check that the selector drum is in the neutral position.
- 3 If any damage or wear has occurred in the gearbox, the removal of the circlips on the gearshafts or selector shafts will allow the component concerned to be replaced. The gearchange drum is a built up assembly and should be renewed rather than repaired.
- 4 The final drive spacer will be left in the oil seal in the crankcase half and can be easily pulled out.

#### 16 Dismantling the engine - removing the crankshaft assembly

Support the crankcase half and tap the end of the mainshaft with a rawhide mallet, to avoid damaging the thread, until the crankshaft assembly is free.

#### 17 Crankshaft and gearbox main bearings - removal

- 1 The crankshaft assembly runs in two journal ball bearings

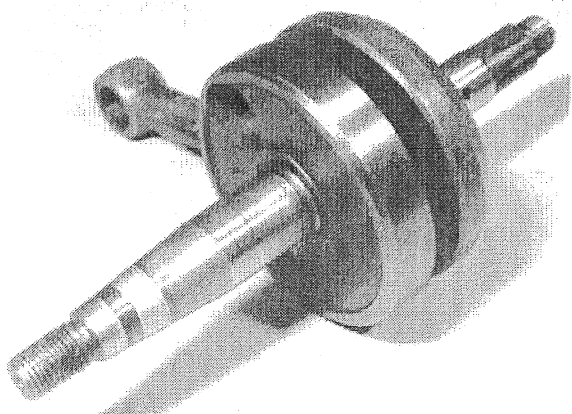

16.1 The complete crankshaft assembly

and the gearbox shafts in two journal ball bearings and two phosphor bronze bushes.

- 2 To remove the gearbox mainshaft journal bearing, the two screws and the bearing retaining plate must be withdrawn.
- 3 Before the bearings can be removed, it is necessary to warm the crankcases by applying a rag soaked in hot water. The bearings can then be tapped out. If the phosphor bronze bearings need renewing the new bearing can be used to push out the old one if a bolt and spacer arrangement is built up.

#### 18 Oil seals - examination and replacement

- 1 Two stroke engines are particularly vulnerable to wear or damage which may occur to the oil seals. This is even so on the Yamaha engine. Apart from the oil leakage that will result, worn crankshaft seals will admit air to the crankcase and dilute the incoming mixture whilst it is under crankcase compression.
- 2 Early warning of failing crankshaft oil seals is given by difficulty in starting and a general reluctance for the engine to run smoothly.
- 3 The oil seals can be prised out of the crankcase but if removed new ones must be fitted.
- 4 The oil seals must be fitted with the manufacturer's marks and letters facing outward.
- 5 When fitting new oil seals, extreme care should be taken when they are inserted over a shaft. To prevent damage to the feather edge of the seal, grease both the shaft and the centre of the oil seal itself.

#### 19 Crankshaft assembly - examination and renovation

- 1 Wash the complete crankshaft assembly with a petrol/paraffin mix to remove all surplus oil.
- 2 Replace the small end caged roller bearing and the gudgeon pin. Check for play between the gudgeon pin and the crankshaft. The play should not exceed 0.080 inch (2 mm).
- 3 If there is more play than is allowable the whole of the crankshaft assembly should be renewed as it is the connecting rod which has worn. To separate the flywheels is a highly specialised task, beyond the normal home garage facilities.

#### 20 Cylinder barrel - examination and renovation

- 1 There will probably be a lip at the uppermost end of the cylinder barrel which marks the limit of travel of the top piston ring. The depth of the lip will give some indication of the

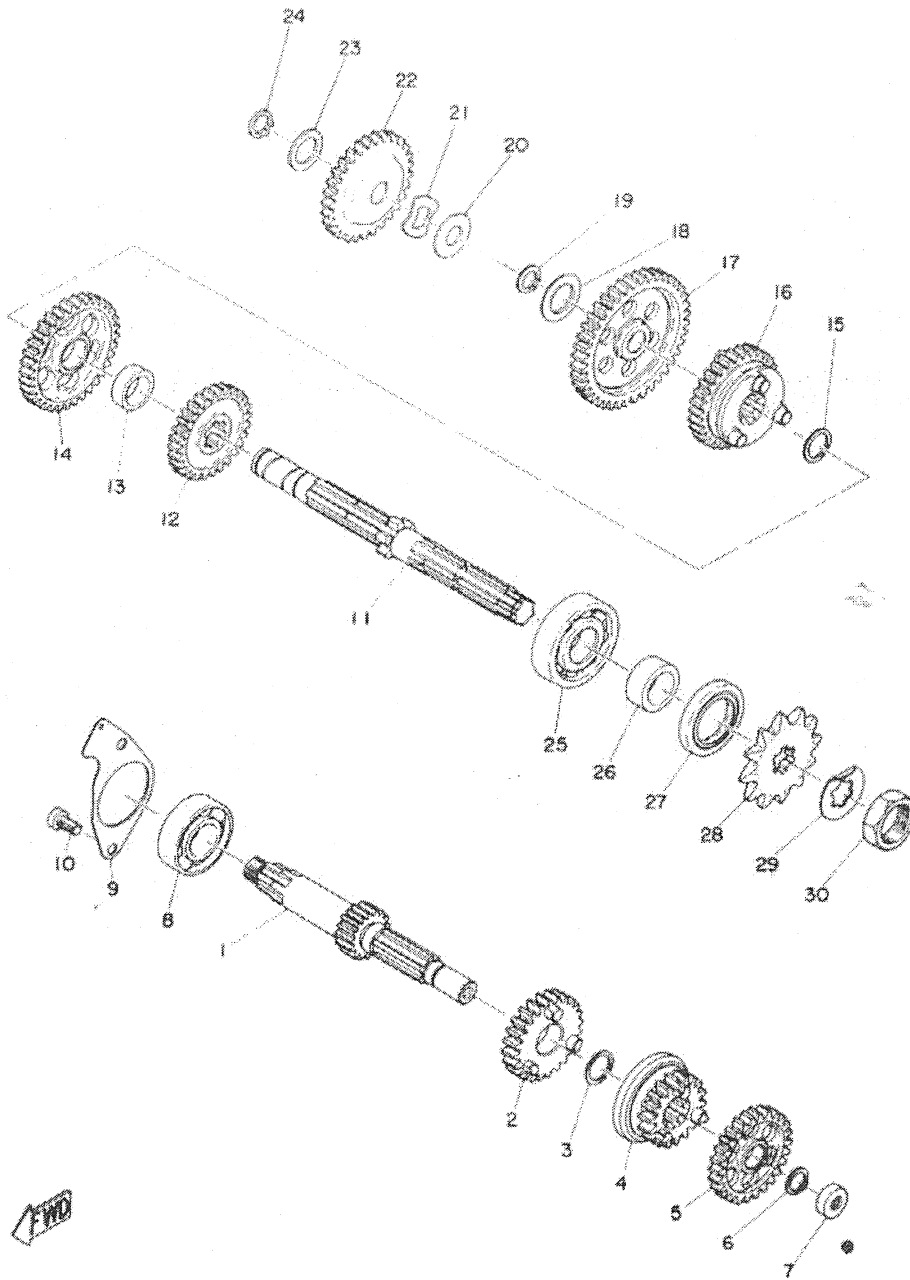

Fig. 1.6. Gearbox components

- |  |  |  |   |
|--|--|--|---|
| 1 Mainshaft                            | 8 Right-hand mainshaft bearing           | 15 Clip                                | (26 teeth)                                  |
| 2 Mainshaft 3rd gear pinion (23 teeth) | 9 Bearing cover plate                    | 16 Layshaft 3rd gear pinion (30 teeth) | 23 Thrust washer                            |
| 3 Clip                                 | 10 Panhead screw for cover plate - 2 off | 17 Layshaft 1st gear pinion (40 teeth) | 24 Circlip                                  |
| 4 Mainshaft 2nd gear pinion (18 teeth) | 11 Layshaft                              | 18 Shim - number as required           | 25 Left-hand layshaft bearing               |
| 5 Mainshaft 4th gear pinion (26 teeth) | 12 Layshaft 4th gear pinion (27 teeth)   | 19 Circlip                             | 26 Distance collar                          |
| 6 Circlip                              | 13 Distance collar                       | 20 Shim - number as required           | 27 Oil seal                                 |
| 7 Push rod seal                        | 14 Layshaft 2nd gear pinion (34 teeth)   | 21 Crinkle washer                      | 28 Final drive sprocket (14 teeth standard) |
|  |  | 22 Kickstarter idler pinion            | 29 Tab washer                               |
|  |  |  | 30 Sprocket retaining nut                   |

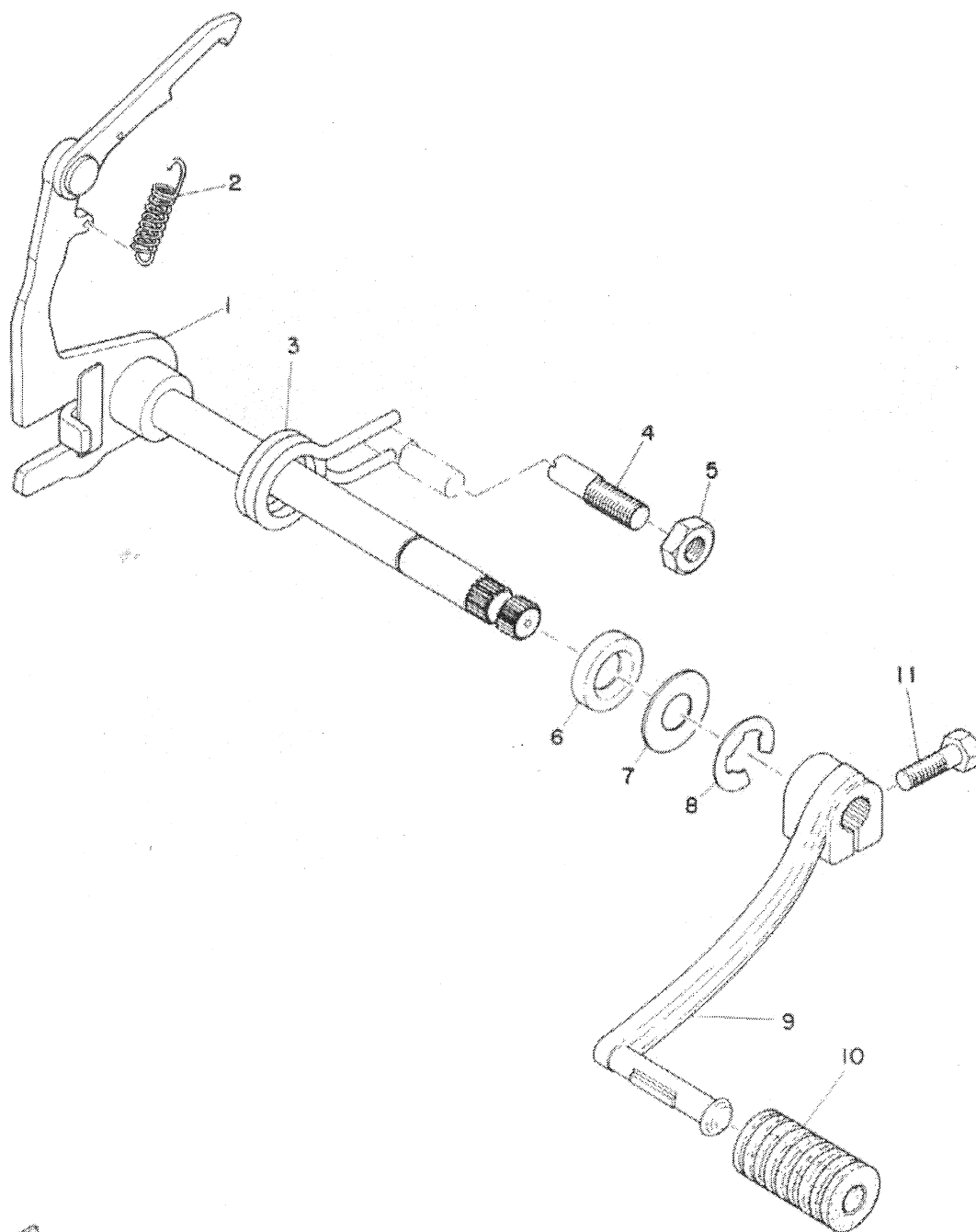

Fig. 1.7. Gear change mechanism

1 Gear change spindle  
assembly

2 Gear change arm return  
spring

3 Gear change spindle  
return spring

4 Adjusting screw

5 Adjuster locknut

6 Oil seal

7 Washer

8 Circlip

9 Gear change pedal

10 Rubber for gear change  
pedal

11 Pedal retaining bolt

FWD



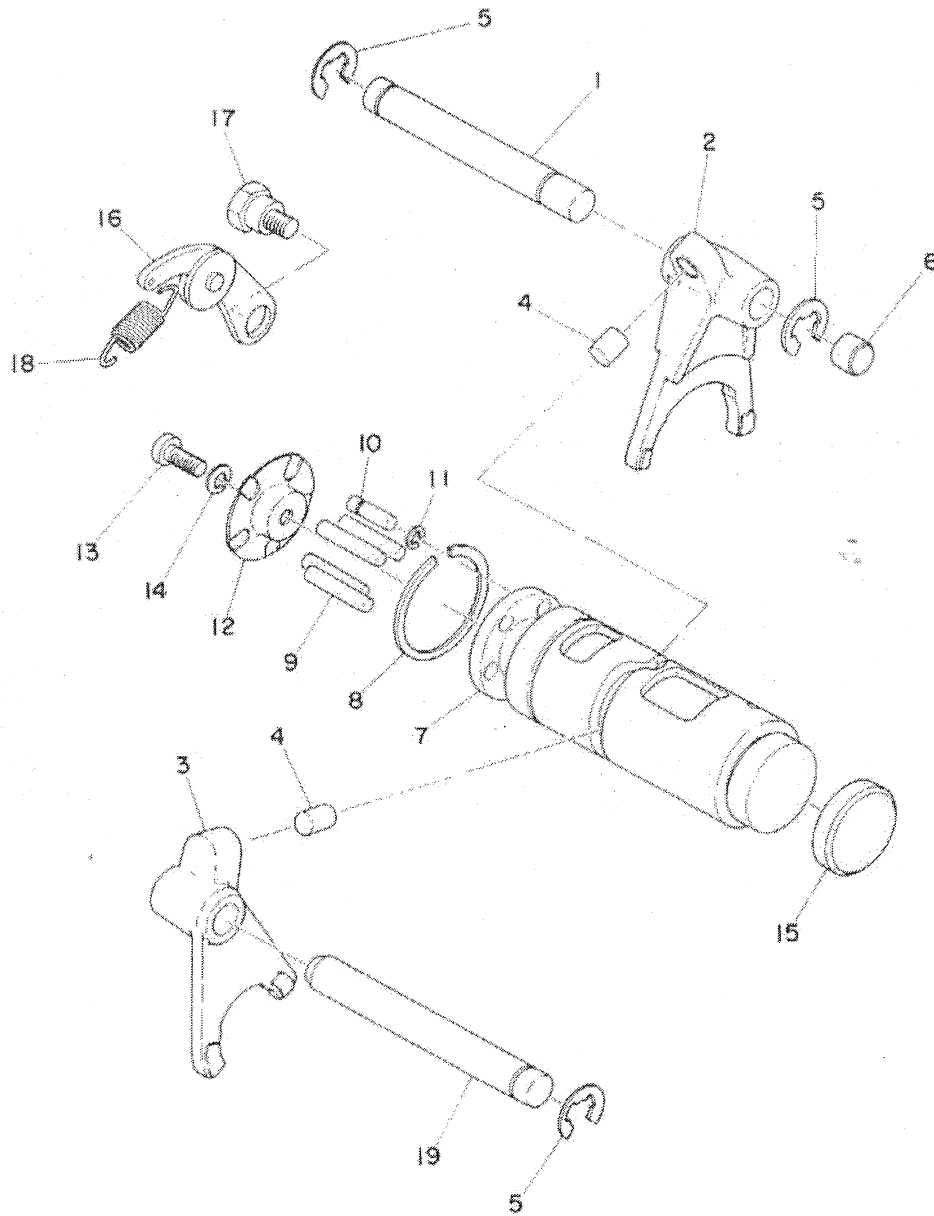

Fig. 1.8. Gear selector drum

- |                            |                      |                                 |                                 |
|----------------------------|----------------------|---------------------------------|---------------------------------|
| 1 Gear selector rod        | 5 Circlip - 3 off    | 10 Locating pin                 | 15 Blanking off plug            |
| 2 Gear selector fork 1     | 6 Blind plug         | 11 Circlip                      | 16 Positive stop lever          |
| 3 Gear selector fork 2     | 7 Gear selector drum | 12 Side plate                   | 17 Bolt for positive stop lever |
| 4 Cam follower pin - 2 off | 8 Circlip            | 13 Panhead screw for side plate | 18 Positive stop spring         |
|                            | 9 Dowel pin - 4 off  | 14 Spring washer                | 19 Gear selector rod            |

amount of bore wear that has taken place, even though the amount of wear is not evenly distributed.

2 Remove the rings from the piston taking great care as they are brittle and very easily broken. There is more tendency for the rings to gum in their grooves in a two-stroke engine. Insert the piston in the bore so that it is positioned about  $\frac{1}{8}$  inch below the top of the bore. If it is possible to insert a 0.014 inch feeler gauge between the piston and the bore, a rebore and the fitting of an oversize piston is necessary.

3 Give the cylinder barrel a close visual inspection. If the surface of the bore is scored or grooved, indicative of an earlier seizure or a displaced circlip and gudgeon pin, a rebore is essential. Compression loss will have a very marked effect on performance.

4 Check that the outside of the cylinder barrel is clean and free from road dirt. Use a wire brush on the cooling fins if they are obstructed in any way. The engine will overheat badly if the cooling area is obstructed in any way. The application of matt cylinder black will help improve heat radiation.

5 Clean all carbon deposits from the exhaust ports and try and obtain a smooth finish in the ports without in any way enlarging them or altering their shape. The size and position of the ports predetermines the characteristics of the engine and unwarranted tampering can produce very adverse effects. An enlarged or re-profiled port does not necessarily guarantee an increase in performance.

#### 21 Piston and piston rings - examination and renovation

1 Attention to the piston and piston rings can be overlooked if a rebore is necessary because new replacements will be fitted.

2 If a rebore is not considered necessary, the piston should be examined closely. Reject the piston if it is badly scored or if it is badly discoloured as the result of the exhaust gases by-passing the rings.

3 Remove all carbon from the piston crown and use metal polish to finish off. Carbon will not adhere so readily to a polished surface.

4 Check that the gudgeon pin bosses are not worn or the circlip grooves damaged. Check also the piston ring pegs, to make sure that none has worked loose.

5 The grooves in which the piston rings locate can also become enlarged in use. The clearance between the piston and the ring in the groove should not exceed 0.002 inch.

6 Piston ring wear can be checked by inserting the rings in the cylinder bore from the top and pushing them down about  $1\frac{1}{2}$  inches with the crown of the piston so that they rest square in the cylinder. If the end gap exceeds 0.014 inch the rings should be replaced.

7 Examine the working surface of the rings. If discoloured areas are evident, the rings should be replaced since the patches indicate the blow-by of gas. Check also that there is not a build-up of carbon behind the tapered ends of the rings, where they locate with the piston ring pegs.

8 It cannot be over-emphasised that the condition of the piston and rings in a two-stroke engine is of prime importance, especially since they control the opening and closing of the ports in the cylinder barrel by providing an effective seal. A two-stroke engine has only three working parts, one of which is the piston. It follows that the efficiency of the engine is very dependent on the condition of this component and the parts with which it is closely associated.

#### 22 Small end - examination and renovation

The small end is a caged roller bearing and is checked at the same time as the crankshaft assembly.

#### 23 Cylinder head - examination and renovation

1 It is unlikely that the cylinder head will require any special attention apart from removing the carbon deposit from the combustion chamber. Finish off with metal polish; a polished surface will reduce the tendency for carbon to adhere and will also help improve the gas flow.

2 Check that the cooling fins are not obstructed so that they receive the full air flow. A wire brush provides the best means of cleaning.

3 Check the condition of the thread where the spark plug is inserted. The thread in an aluminium alloy cylinder head is damaged very easily if the spark plug is overtightened. If necessary, the thread can be reclaimed by fitting what is known as a Helicoil insert. Most agents have facilities for this type of repair, which is not expensive.

4 If the cylinder head joint has shown signs of oil seepage when the machine was in use, check whether the cylinder head is distorted by laying it on a sheet of plate glass. Severe distortion will necessitate a replacement head but if the distortion is only slight it is permissible to wrap some emery cloth (fine grade) around the sheet of glass and rub down the joint using a rotary motion, until it is once again flat. The usual cause of distortion is uneven tightening of the cylinder head nuts.

#### 24 Crankcases - examination and renovation

1 Inspect the crankcases for cracks or any other signs of damage. If a crack is found, specialist treatment will be required to effect a satisfactory repair.

2 Clean off the jointing faces using a rag soaked in methylated spirit to remove old gasket cement. Do not use a scraper because the jointing surfaces are damaged very easily. A leak-tight crankcase is an essential requirement of any two-stroke engine. Check also the bearing housings, to make sure they are not damaged. The entry to the housings should be free from burrs or lips.

#### 25 Clutch actuating mechanism - examination

1 The clutch actuating mechanism and adjuster are attached to the generator cover. It is unlikely that these parts will require attention, particularly if the actuating mechanism has been greased regularly during routine maintenance.

2 Should it be necessary to dismantle the mechanism, unclip the return spring, unscrew the adjuster locknut and press the actuating lever out of its bush. The lever works on the quick-start worm principle and is unlikely to give trouble unless it is under-lubricated.

#### 26 Clutch assembly - examination and renovation

1 Examine the condition of the linings of the fibre clutch plates. If they are damaged, loose or have worn thin, replacements will be required.

2 Examine the tongues of the plain clutch plates, where they engage with the clutch drum. After an extended period of service, burrs will form on the edges of the tongues which will correspond with grooves worn in the clutch drum slots. These burrs must be removed, by dressing with a smooth file.

3 The grooves worn in the clutch drum slots can be dressed in a similar manner, making sure that the edges of the slots are square once again. If this simple operation is overlooked, clutch troubles will persist because the plates tend to lodge in the grooves when the clutch is withdrawn and promote clutch drag.

4 Check the condition of the clutch springs. They should have a free length of  $1\frac{1}{16}$  inch and must be replaced if they compress much below this figure.

5 The clutch pushrod is in two sections, separated by a ball

bearing; a long section of approximately 5½ inches and a short length of approximately 2 inches. Replace either section of the rod if the ends show a tendency to bell out. This is usually a sign of insufficient free play in the actuating mechanism, which has caused the ends to press together and generate heat, which in turn has destroyed the temper and caused them to soften and wear rapidly. The need for continuous clutch adjustment can invariably be traced to this type of fault.

### 27 Primary gear pinions - examination

Both primary gear pinions should be examined closely to ensure there is no damage to the helical teeth. The depth of mesh is predetermined by the bearing locations and cannot be adjusted.

### 28 Reassembly - general

- 1 Before the engine, clutch and gearbox components are reassembled, they must be cleaned thoroughly so that all traces of old oil, sludge, dirt and gaskets are removed. Wipe each part clean with a dry, lint-free rag to make sure that there is nothing to block the internal oilways of the engine.
- 2 Lay out all the spanners and other tools likely to be required so that they are close at hand during the reassembly sequence. Make sure the new gaskets and oil seals are available - there is nothing more infuriating than having to stop in the middle of a reassembly sequence because a gasket or some other vital component has been overlooked.
- 3 Make sure that the reassembly area is clean and unobstructed and that an oil can with clean engine oil is available so that the parts can be lubricated before they are reassembled. Refer back to the torque wrench settings and clearance data where necessary. Never guess or take a chance when this data is available.
- 4 Do not rush the reassembly operation or follow the instructions out of sequence. Above all, do not use excess force when parts will not fit together correctly. There is invariably good reason why they will not fit, often because the wrong method of assembly has been used.

### 29 Engine reassembly - fitting bearings to crankcase

- 1 Before fitting the crankcase bearings, make sure that the bearing surfaces are scrupulously clean and that there are no burrs or lips on the entry to the housings. Press or drive the bearings into the cases, using a mandrel and hammer, after first making sure that they are lined up squarely. Warming the crankcases will help when a bearing is a particularly tight fit.
- 2 When the bearings have been driven home, lightly oil them and make sure they revolve freely. This is particularly important in the case of the main bearings.
- 3 Using a soft mandrel, drive the oil seals into their respective locations. Do not use more force than is necessary because the seals will damage very easily. Good crankcase seals are essential to the efficient running of any two-stroke engine and if there is any doubt about the condition of the old seals they should be replaced without hesitation. Poor starting and indifferent running can often be attributed to worn or damaged oil seals, which allow air to enter the crankcase and dilute the incoming mixture whilst it is under crankcase compression.
- 4 Replace the bearing retaining plate on the gearbox main bearing.

### 30 Engine reassembly - fitting the crankshaft assembly

Feed the crankshaft assembly into the left hand crankcase

ensuring that the crankshaft shims are in place. Find suitable spacers and the rotor nut and draw the crankshaft assembly into the crankcase. Several spacers will be required as the thread length for the rotor nut is relatively short, so several 'bites of the cherry' will be required.

### 31 Engine reassembly - gearbox components

- 1 Support the crankcase on blocks.
- 2 Put the mainshaft and layshaft in mesh in one hand, rest the selector drum on top, pyramid fashion, feed the mainshaft selector fork into its groove and rotate it to put the roller into the cam track on the selector drum. Repeat for the layshaft selector. Hold everything in place with the other hand and feed the layshaft into its bearing. The mainshaft will find its bearing next, followed by the selector pins and the selector drum. The gear cluster should slide in, but if difficulty is experienced, check that the selector drum is in neutral and gently ease the components in. Do not use excessive force. Check that the shafts rotate.

### 32 Engine reassembly - rejoining the crankcases

- 1 Smear the joint face with Golden Herculite or other jointing compound.
- 2 Check that the crankshaft shims are in position.
- 3 Lower the right hand crankcase onto the shafts. Gentle tapping may be required to push the crankshaft into its bearing. Note that the two hollow dowels must locate in the right hand crankcase.
- 4 When the crankcases are together, rotate the shafts to ensure that no binding occurs.
- 5 Excessive force should not be used as this shows that something has been wrongly assembled or is out of alignment.
- 6 Replace the twelve screws as shown in Fig.1.2, and refit the neutral light switch.
- 7 The mainshaft drive spacer can then be pushed into the oil seal on the left hand side of the engine. Use great care so that the seal is not damaged.
- 8 Replace the oil drain plug after checking that the sealing washer is in good condition.

### 33 Engine reassembly - reassembling the disc valve

- 1 Replace the drive pin in the crankshaft and slide on the drive collar.
- 2 Oil the surface on which the valve disc runs to lubricate it and to form a seal to reduce air leaks.
- 3 Place the valve disc onto the drive collar ensuring that the two spots on the disc line up with the pin in the crankshaft.
- 4 A small amount of oil should be put on the disc for the same reasons as before.
- 5 The disc cover plate is then replaced, ensuring that the carburettor stub lines up with the hole in the crankcase, and the six retaining screws inserted and tightened.
- 6 Replace the spacer, helical gear and Belleville washer and lock to the crankshaft with the nut.

### 34 Engine reassembly - reassembling the gearchange mechanism and index arm

- 1 Hook the index arm spring into the bearing retaining plate and the index arm and pull the index arm across to allow the shouldered bolt to screw into the crankcase.
- 2 Ensure that the gearchange return and pawl springs are in position. Feed the shaft through the crankcases, pulling the pawl clear of the selector drum whilst easing the gearchange spring over its pin to allow the gearchange assembly to seat home.
- 3 Replace the washer and circlip on the gearshaft on the other

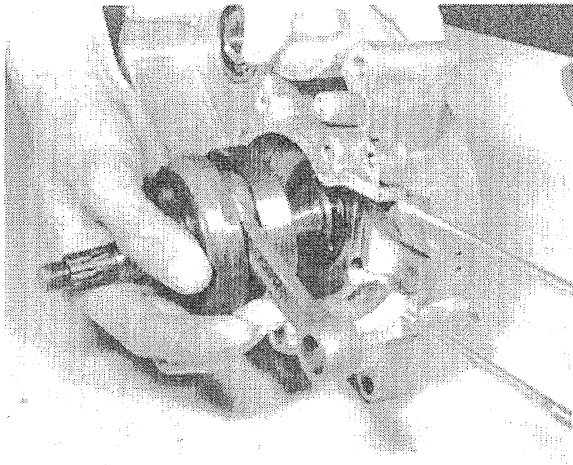

30.1a Feed crankshaft assembly into left-hand crankcase first

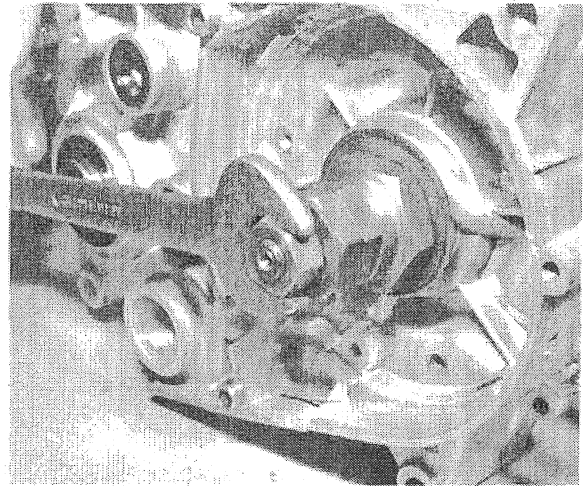

30.1b Use spacer assembly to draw crankshaft into position without damage



31.2a Mesh gear trains prior to assembly and fit with gear selector drum

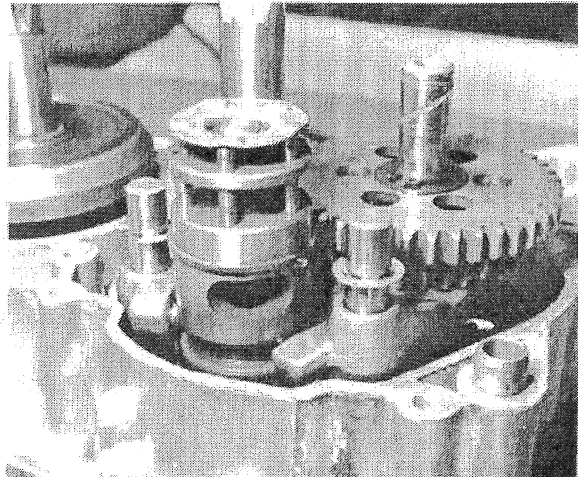

31.2b Feed in mainshaft selector first, then layshaft selector before fitting whole assembly in crankcase

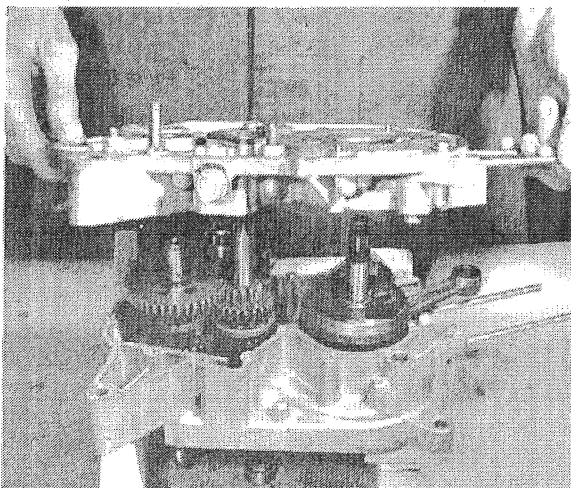

32.1 Check the gear shafts rotate before fitting other crankcase half

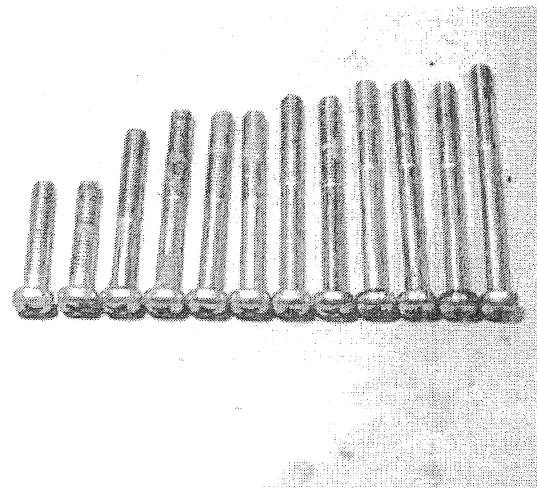

32.6 The twelve crankcase screws must be replaced in correct order

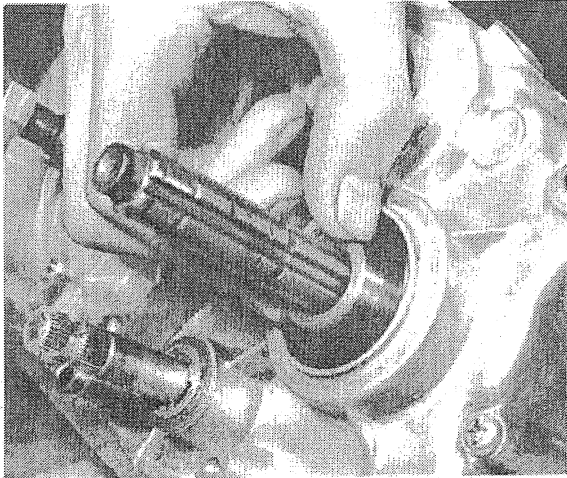

32.7 Push crankshaft drive spacer through oil seal with great care

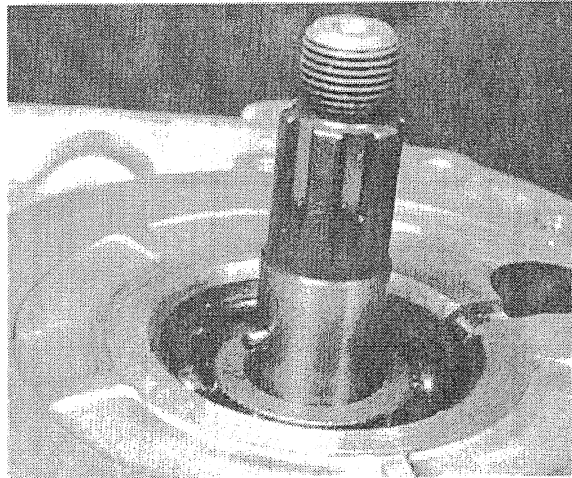

33.1a Replace drive pin in end of crankshaft and ...

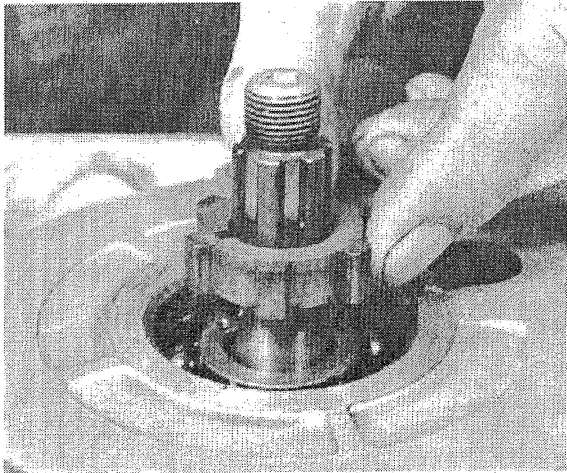

33.1b ... slide on drive collar to engage with pin

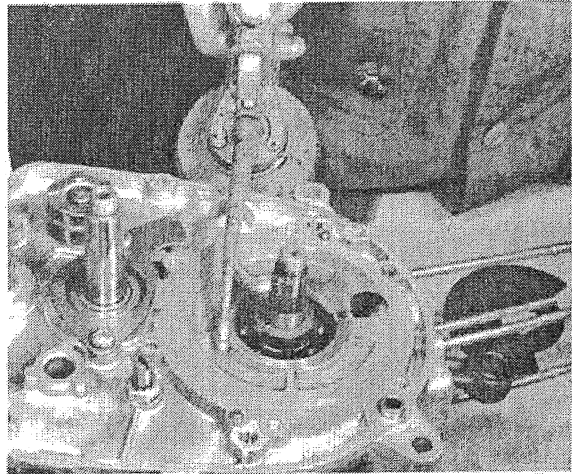

33.2 Lubricate surface before fitting disc valve

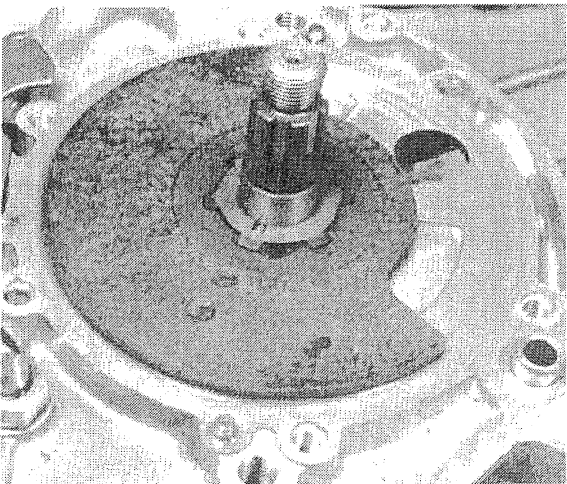

33.3 Correct location of disc valve in relation to crankshaft is essential

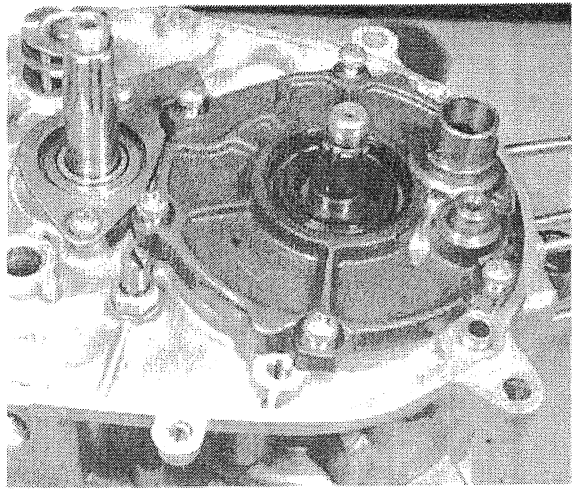

33.5 Fit cover plate ensuring carburettor stub lines up with intake

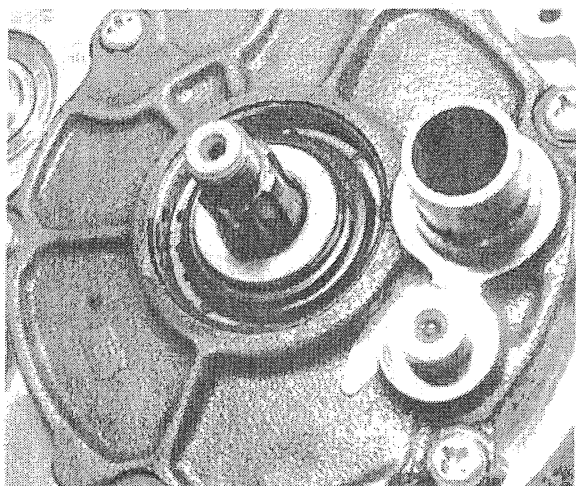

33.6a Replace spacer, followed by ...

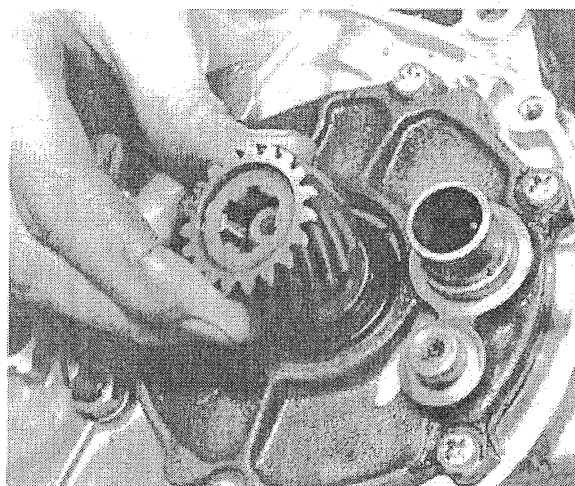

33.6b ... helical drive pinion, then fit nut and ...

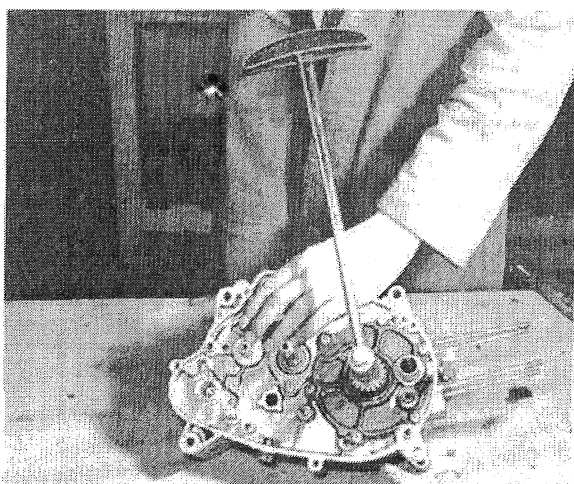

33.6c ... tighten to recommended torque setting

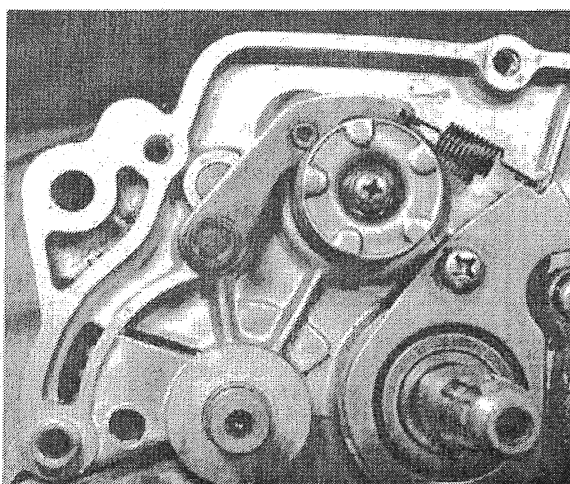

34.1 Refit gear indexing arm

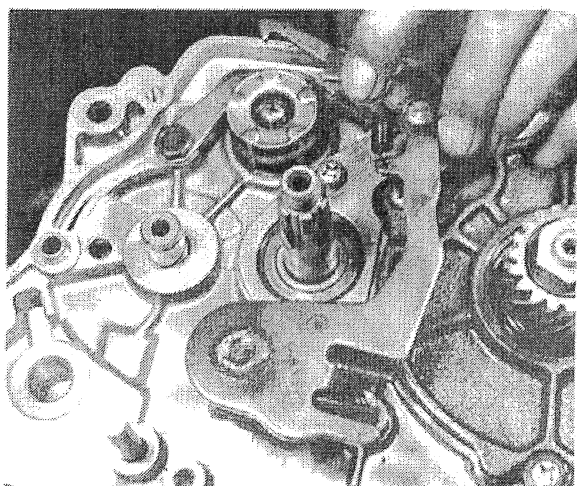

34.2 Feed gear change shaft through crankcases and engage pawl with selectors

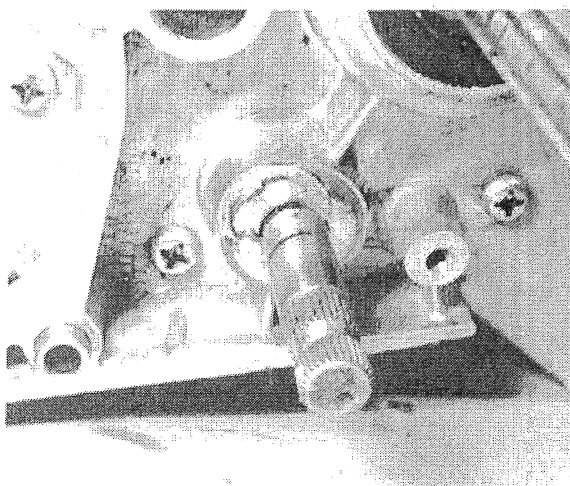

34.3 Replace washer and circlip on end of gear change shaft

side of the engine.

### 35 Engine reassembly - reassembling the kickstarter mechanism

- 1 Replace the thrust washer, sleeve and gear (with dogs uppermost) on the mainshaft.
- 2 Assemble on the layshaft a plain washer, the crinkle washer, the idler pinion and another plain washer. A circlip retains them all on the layshaft.
- 3 Reassemble the return spring sub-assembly by putting the small spring onto the shaft and put the gear on the shaft, ensuring that the spring sits in its correct position and retains the gear with the circlip. Assemble the plain spring register and the return spring ensuring that the end of the return spring is located in the hole in the shaft. The slotted spring register can now be fed into the spring and retained with the circlip.
- 4 The return spring sub-assembly can now be placed in the crankcase ensuring that the small spring locates in the special cast slot. The return spring is then hooked onto its pillar.

### 36 Engine reassembly - reassembling the clutch

- 1 The clutch drum is placed on the sleeve on the mainshaft. A slight anticlockwise twist is needed to mesh the helical gears and to lock the dogs on the clutch drum with the dogs on the gear.
- 2 The thrust washer, clutch centre, tab washer and nut are then assembled. Lock the clutch centre with a piece of metal and tighten the nut. Prise up the tab washer to lock the nut.
- 3 The plain portion of the pushrod is then pushed down the centre of the mainshaft, followed by the small ball bearing and the headed pushrod portion. The oil seal on the other side of the engine should hold the plain portion of the pushrod in position.
- 4 The clutch plates are assembled in this order: a fibre plate locating in the clutch drum, a plain aluminium plate locating on the clutch centre and another fibre plate.
- 5 The pressure plate is then assembled and the four springs and screws which hold everything in place. The screws should be tightened compressing the springs until the head contacts the pressure plate. If these screws are not tightened sufficiently, the clutch will slip when power from the engine is applied. If they are tightened unevenly the pressure plate will not disengage squarely and clutch drag will occur when the clutch lever is pulled in.
- 6 Replace the two O rings, one on the carburettor stub and one on the boss adjacent to it. Refit the right hand cover, making sure that the dowels fit correctly, and replace the seven screws noting that the long one is fitted adjacent to the carburettor stub.

### 37 Engine reassembly - replacing the final drive sprocket

- 1 Check that the spacer has been fitted and is properly seated in the oil seal. Refit the neutral indicator lamp switch and replace the plug which seals off the end of the gear selector drum.
- 2 Onto the drive shaft slide the sprocket, tab washer and locking sleeve complete with the nut.
- 3 Locate the two half collets in the groove in the drive shaft and finger-tighten the nut ensuring that the two half collets locate in the recess in the end of the sleeve.
- 4 Lock the engine and fully tighten the nut.
- 5 Prise the tab washer up to lock the nut.
- 6 Refit the circlip on the drive shaft.

### 38 Engine reassembly - fitting the flywheel generator

- 1 The Woodruff key should now be tapped into the crankshaft.
- 2 The stator and its two fixing screws are then replaced, making sure that the wires feed out at the top of the engine so that the rubber grommet can be pushed back in its slot.
- 3 The neutral warning light switch can now be reconnected.

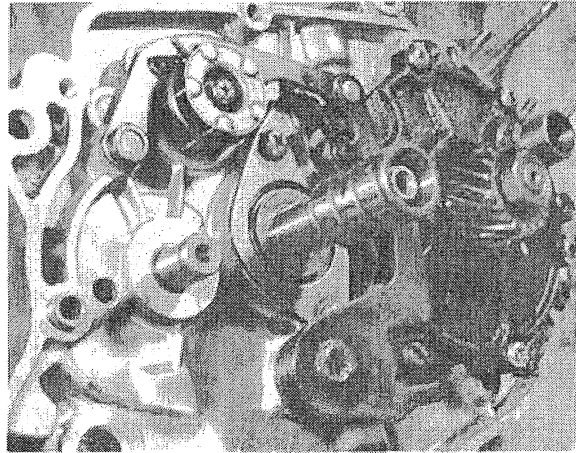

35.1a Thrust washer and sleeve fit over gearbox mainshaft, followed by ...

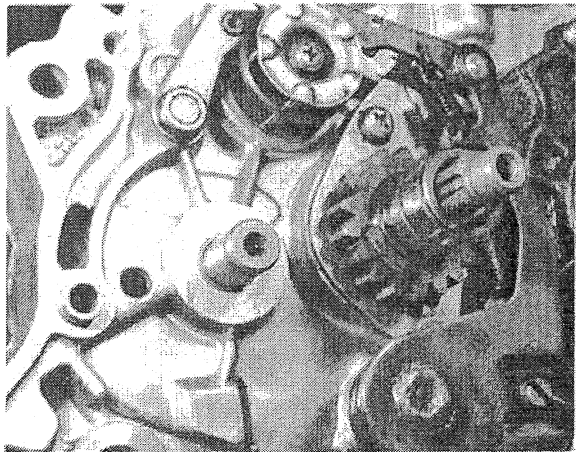

35.1b ... pinion with dogs uppermost

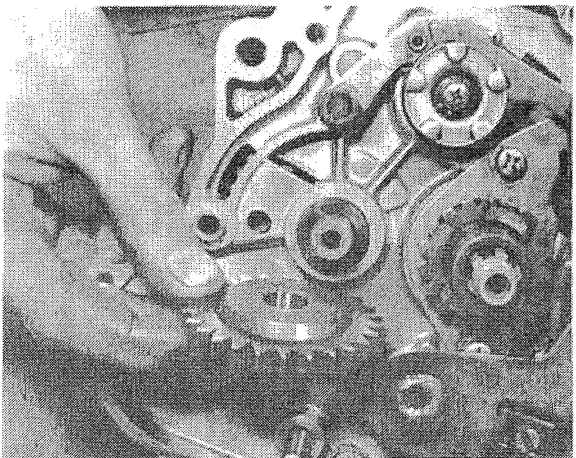

35.2a Plain washer and crinkle washer fit below idler pinion ...

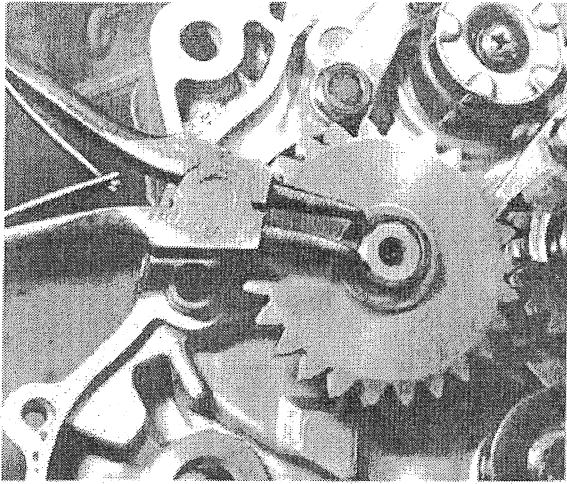

35.2b ... plain washer and retaining circlip on top of pinion

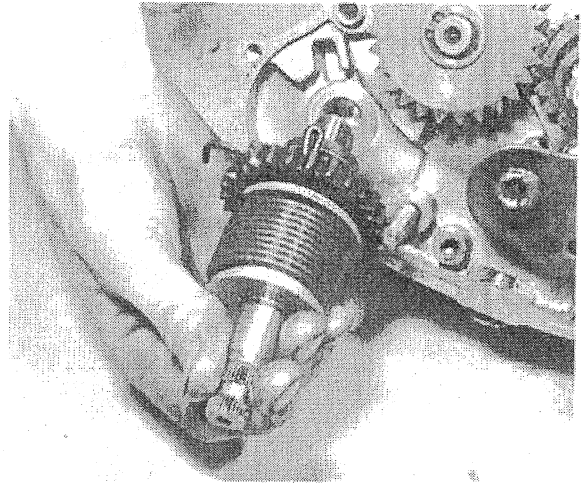

35.3 Kickstarter return spring assembly fits next

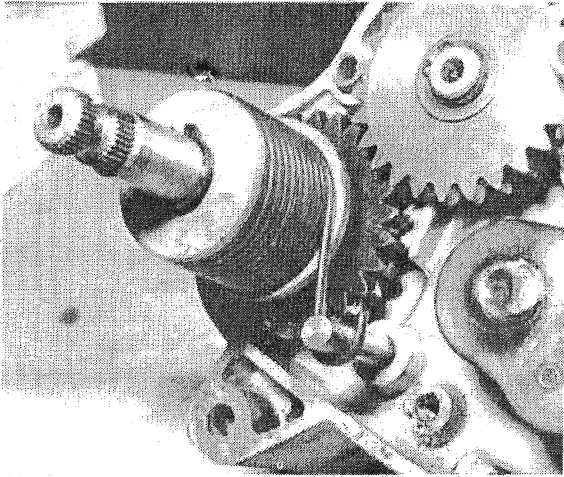

35.4 Loop arm of return spring around extending pillar

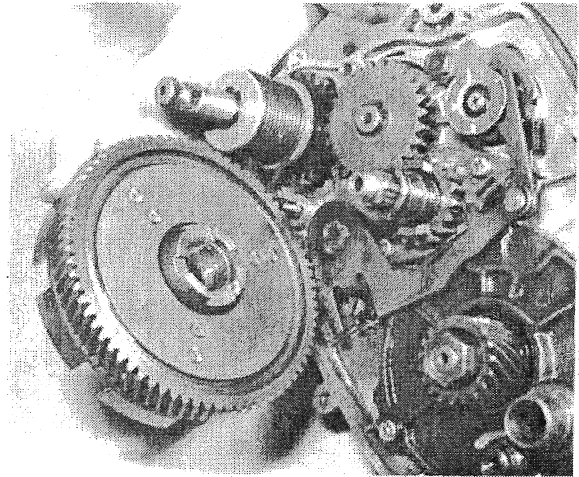

36.1 Place clutch drum over sleeve so that dogs engage with those of pinion

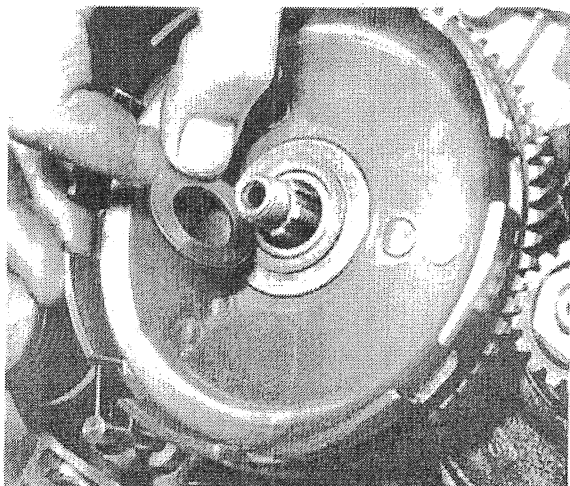

36.2a Do not omit thrust washer before fitting clutch centre

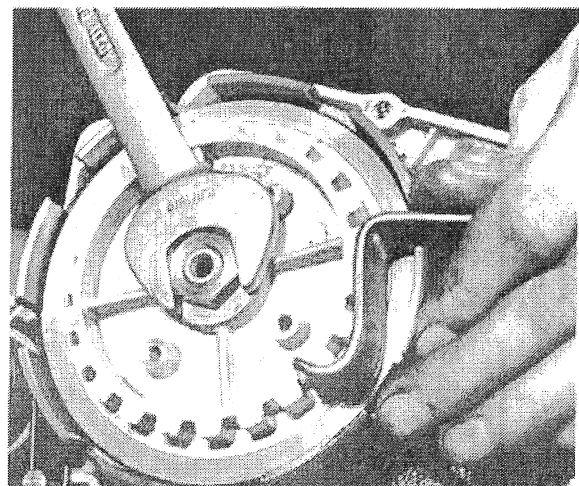

36.2b Lock clutch centre so that nut can be fully tightened



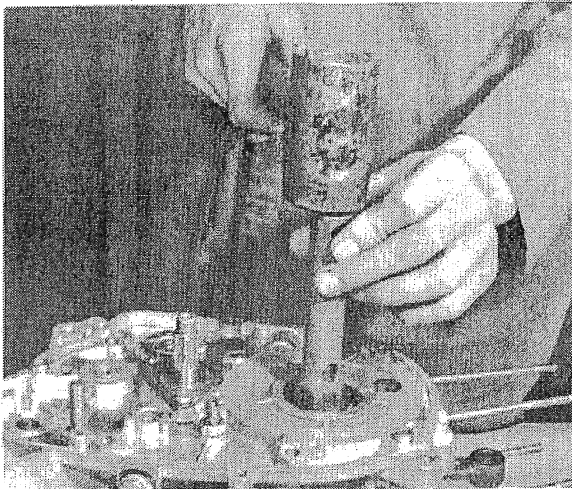

37.1a Check the spacer is seating correctly

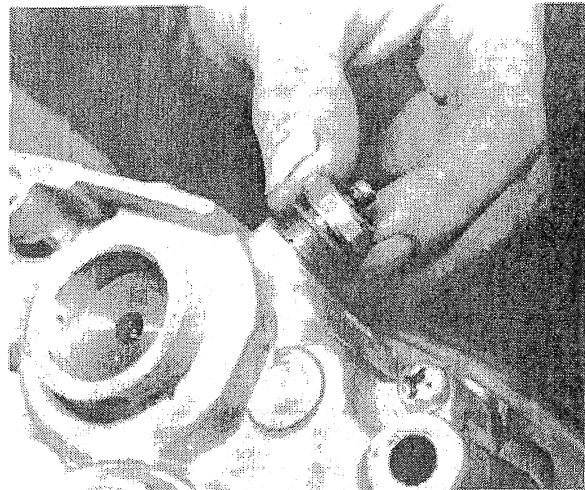

37.1b Refit the neutral indicator lamp switch

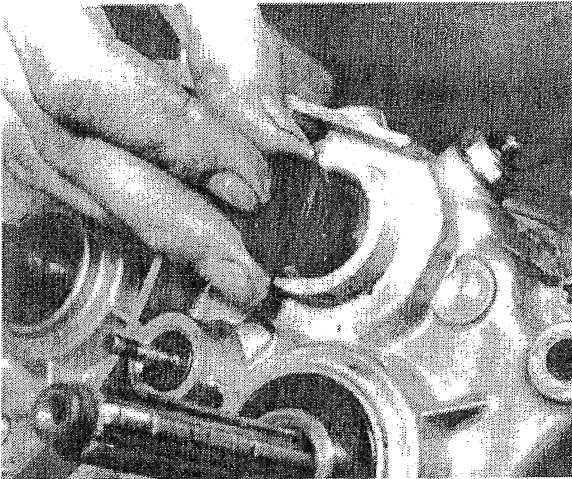

37.1c Do not omit the seal for the gear selector drum

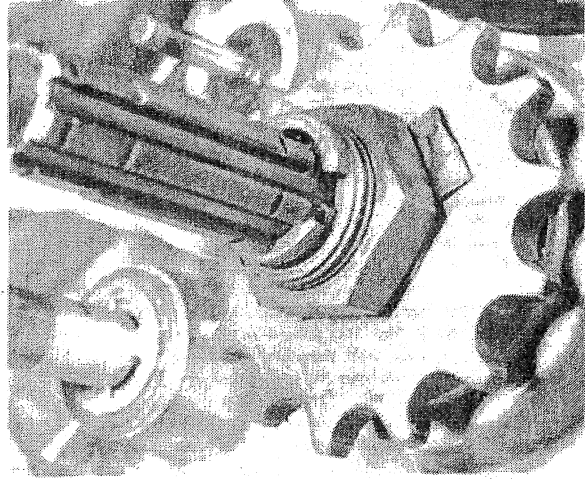

37.3 Locate the two collets in the end of the threaded sleeve

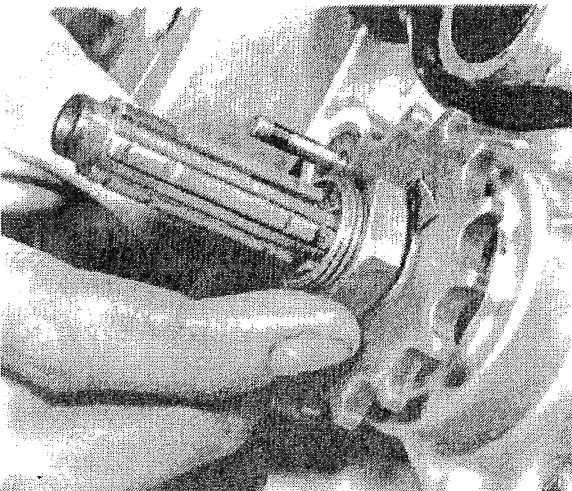

37.4 Lock the engine and fully tighten the nut

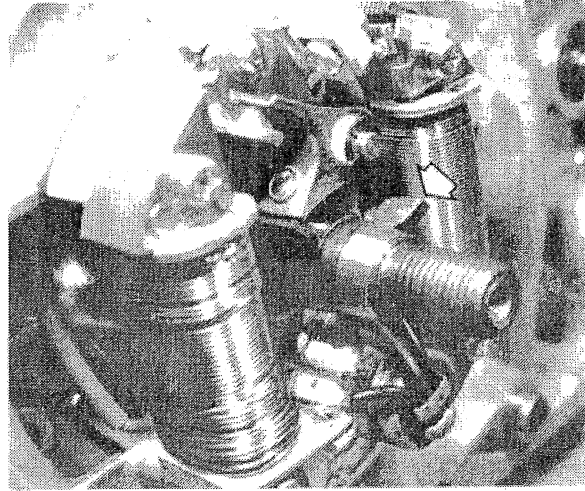

38.1 Replace the Woodruff key in the end of the crankshaft



4 Before fitting the flywheel rotor, place a few drops of light oil on the felt wick which lubricates the contact breaker cam in the centre of the flywheel rotor.

5 It is advisable to check also whether the contact breaker points require attention at this stage, otherwise it will be necessary to withdraw the flywheel rotor again in order to gain access. Reference to Chapter 3 will show how the contact breaker points are renovated and adjusted.

6 Feed the rotor onto the crankshaft so that the slot lines up with the Woodruff key. The rotor may have to be turned to clear the heel of the contact breaker before it will slide fully home.

7 The washer and rotor nut can now be fitted and the nut fully tightened.

### 39 Engine reassembly - fitting the piston, cylinder barrel and cylinder head

1 Raise the connecting rod to its highest point and pad the mouth of the crankcase with clean rag as a precaution against displaced parts falling into the crankcase. Replace the caged roller small end bearing. Fit the piston, complete with rings, after oiling both the gudgeon pin and the small end bearing. To aid replacement in the correct position the piston crown is marked with an arrow head. This must face in the direction of the exhaust port or downward.

2 If the gudgeon pin is a tight fit in the piston bosses, warm the piston first. This will expand the metal and make the refitting easier.

3 Replace both circlips, making sure that they are fully engaged with their retaining grooves. A displaced circlip can cause severe engine damage. Never re-use the original circlips; always fit new replacements.

4 Fit a new cylinder base gasket. No gasket cement is required at this joint.

5 Smear the cylinder bore with clean oil and lower the cylinder barrel down the holding down studs until it can be engaged with the piston. Check that the piston rings are correctly lined up with the piston pegs and then compress the rings so that the piston can be inserted into the cylinder bore. The spigot of the cylinder barrel has a taper, to facilitate the entry of the piston rings. Do not use force; the piston rings are brittle and will break very easily if they become trapped.

6 When the piston and rings have passed into the cylinder bore, remove the crankcase padding and slide the cylinder barrel and piston downward until the spigot of the cylinder barrel enters the mouth of the crankcase and the flange seats correctly on the new cylinder base gasket.

7 Fit a new cylinder head gasket to the top flange of the cylinder barrel. This is a plain copper gasket.

8 Gasket cement is not required at the cylinder head joint.

9 Lower the cylinder head into position. Replace the four cylinder head nuts and washers and tighten them in a diagonal sequence, a little at a time, until the recommended torque wrench setting is achieved. Check that the piston is free from any tight spots when the crankshaft is turned before proceeding to the next sequence of operations.

### 40 Refitting the engine/gearbox unit in the frame

1 Follow in reverse the procedure given in Section 5 of this Chapter. Fit the spark plug as soon as the engine unit is lifted into the frame and the engine bolts are replaced, to prevent dirt and foreign matter from dropping into the engine.

2 Use a new copper ring gasket for the exhaust pipe joint. A leaktight exhaust system is essential for the correct running of the engine.

3 Refit the kickstarter and gear change levers so that they are positioned at the correct angles. These are easier to determine when the engine is in the frame.

4 Remove the gearbox oil filler plug from the top of the right hand crankcase and refill the gearbox with SAE 30 Oil. The filler

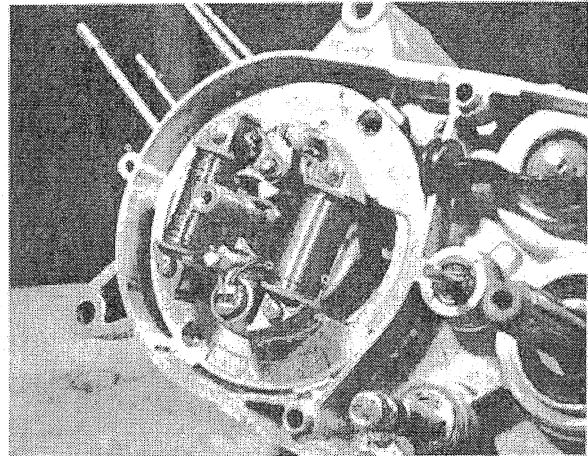

38.2 Make sure stator wires feed out at top of engine unit.

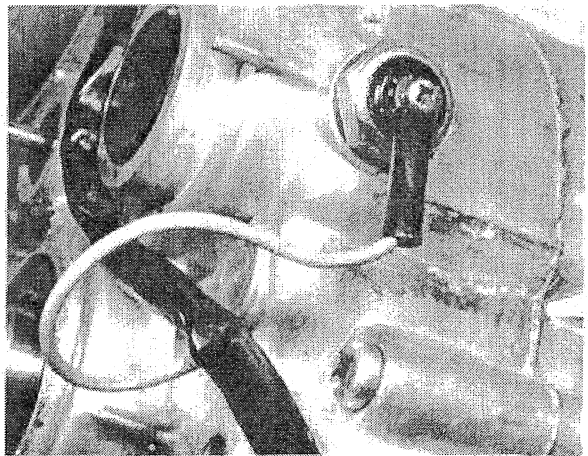

38.3 Reconnect neutral warning lamp switch

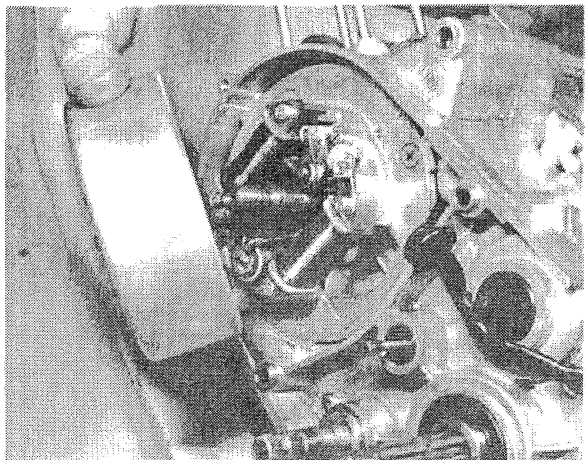

38.6 Refit rotor to line up with key in crankshaft

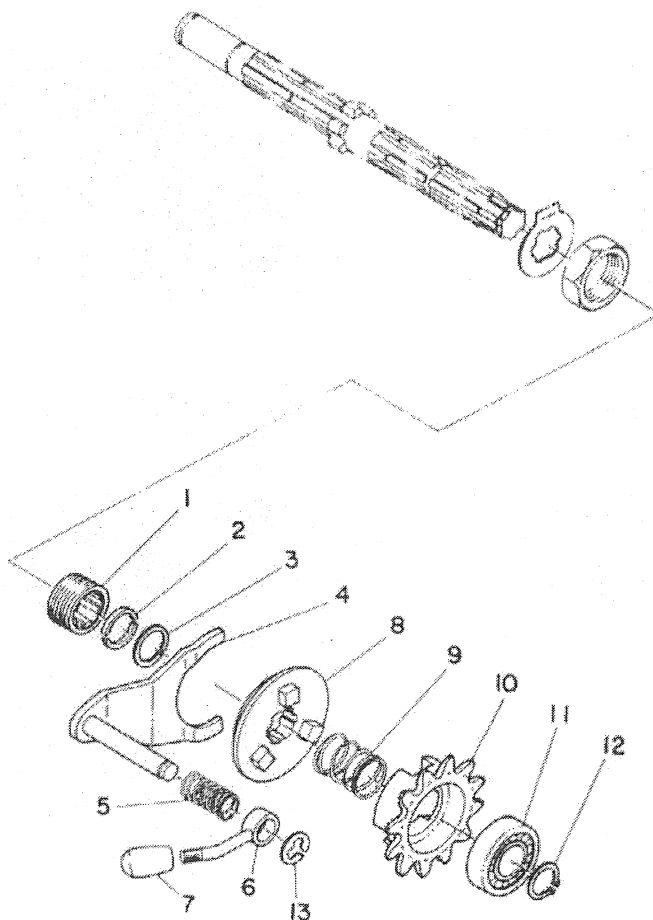

Fig. 1.9. Pedal engagement assembly

1 Threaded collar  
2 Collets - 2 off  
3 Circlip

4 Transmission change fork  
5 Lever return spring  
6 Transmission change lever

7 Knob for transmission  
change lever  
8 Transmission change dogs

9 Transmission change spring

10 Drive sprocket from  
pedals (12 teeth)

11 Bearing

12 Circlip

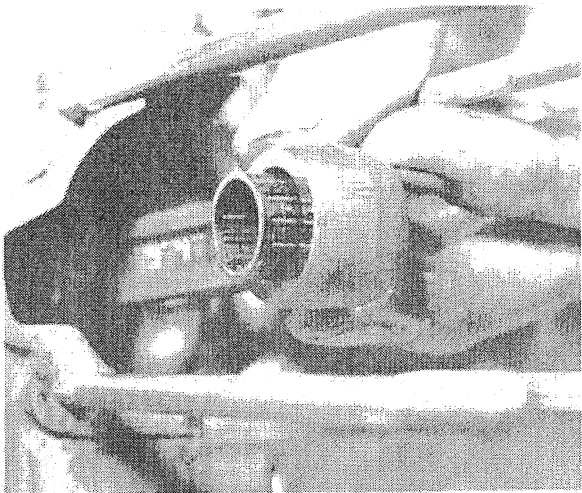

39.1a Replace the caged roller small end bearing

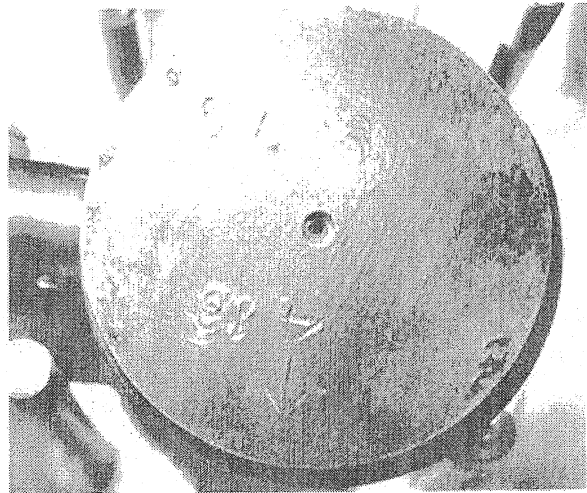

39.1b Refit the piston so that the arrow points to the exhaust port

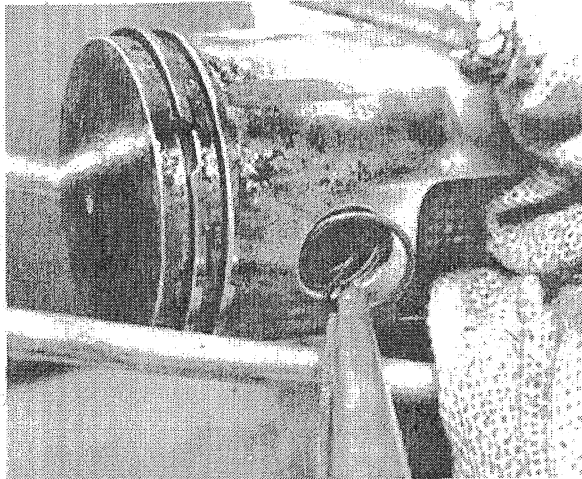

39.3 Always fit new circlips - never re-use the originals

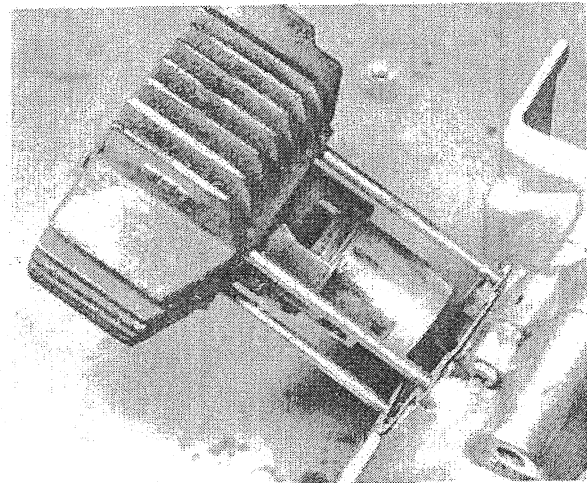

39.5 Smear cylinder barrel with oil before lowering into position

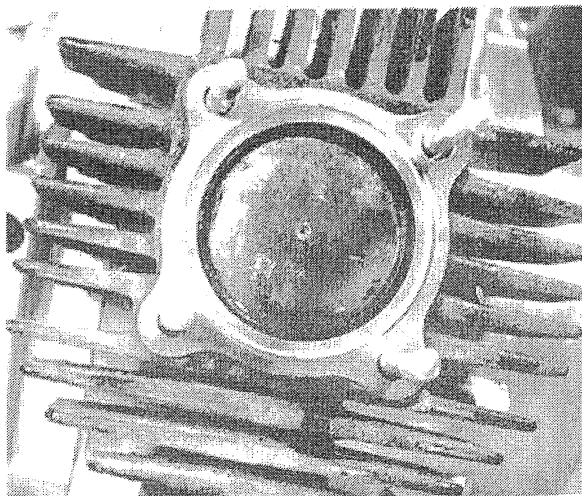

39.7 Use a new cylinder head gasket

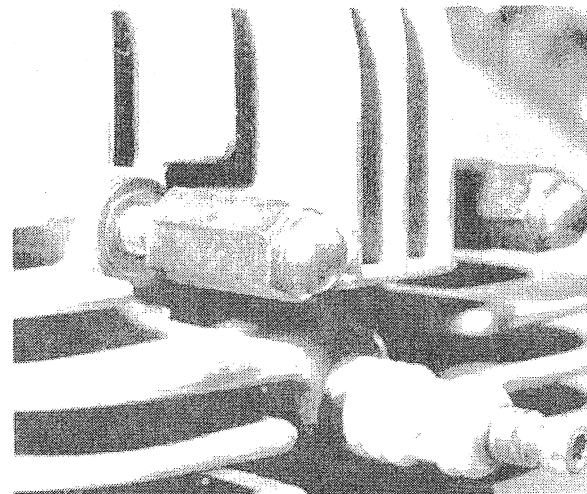

39.9 Tighten cylinder head nuts in a diagonal sequence to the recommended torque setting

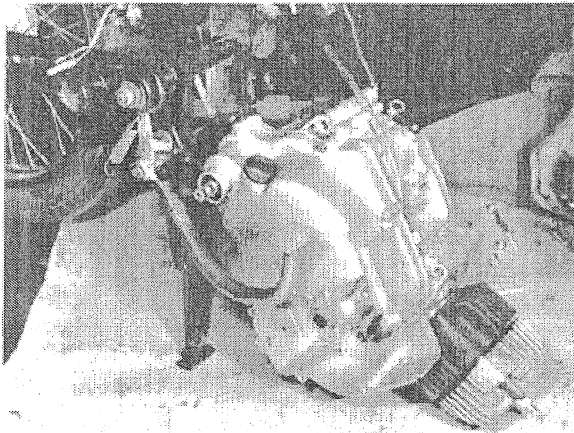

40.1a Refit lower engine bolt first, to act as a pivot

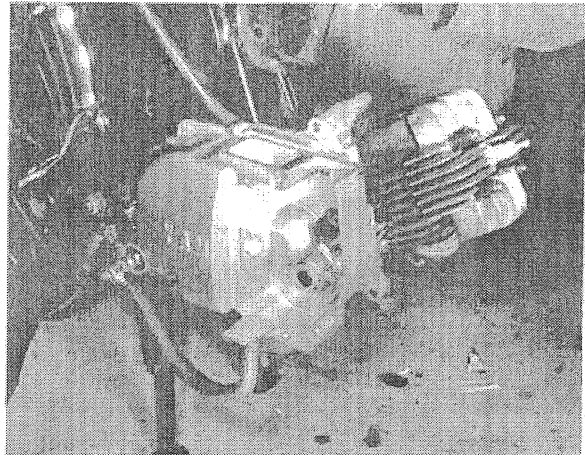

40.1b Swing engine up into position and replace other engine bolts

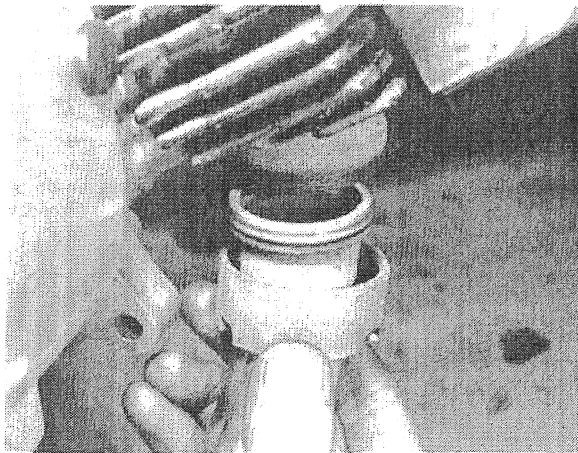

40.2 Use new ring gasket at exhaust pipe joint

cap has an integral dipstick; oil should be added until it reaches the groove when the machine is standing on level ground. Do not overfill.

**41 Starting and running the rebuilt engine**

- 1 When the initial start-up is made, run the engine slowly for the first few minutes, especially if the engine has been rebored. Check that all the controls function correctly and that there are no oil leaks before taking the machine on the road.
- 2 Remember that a good seal between the piston and the cylinder barrel is essential for the correct functioning of any two-stroke engine. In consequence, a rebored engine will require more careful running-in than its four-stroke counterpart. There is a far greater risk of engine seizure during the first hundred miles if the engine is permitted to work hard.
- 3 Do not add extra oil to the petrol/oil mix in the mistaken belief that it will aid running in. More oil means less petrol and the engine will run with a permanently weakened mixture, causing overheating and a far greater risk of engine seizure. Keep to the recommended proportions.
- 4 Do not tamper with the exhaust system or run the engine without the baffles fitted to the silencer. Unwarranted changes in the exhaust system will have a very noticeable effect on engine performance, invariably for the worst.

**42 Fault diagnosis - engine**

| Symptom               | Reason/s  | Remedy  |
|-----------------------|---|---|
| Engine will not start | Defective spark plug                                      | Remove plug and lay on cylinder head. Check whether spark occurs when engine is kicked over.    |
|                       | Dirty or closed contact breaker points                    | Check condition of points and whether gap is correct.   |
|                       | Air leak at crankcase or worn oil seals around crankshaft | Flood carburettor and check whether mixture is reaching the spark plug.                         |
|                       | Clutch slip   | Check and adjust clutch.  |
| Engine runs unevenly  | Ignition and/or fuel system fault                         | Check systems as though engine will not start.  |
|                       | Blowing cylinder head gasket                              | Leak should be evident from oil leakage where gas escapes. Check timing and reset if necessary. |
|                       | Incorrect ignition timing                                 | Check timing and reset if necessary.  |
|                       | Loose pin on which moving contact breaker point pivots    | Renew defective parts.  |

|                            |  |   |
|----------------------------|--|---|
| Lack of power              | Incorrect ignition timing<br>Fault in fuel system<br>Blowing head gasket<br>Choked silencer  | See above.<br>Check system and filler cap vent.<br>See above.<br>Clean out baffles.   |
| High fuel/oil consumption  | Cylinder barrel in need of rebore and o/s piston<br>Oil leaks or air leaks from damaged gaskets or oil seals                         | Fit new rings and piston after rebore.<br>Trace source of leak and replace damaged gaskets or seals.                            |
| Excessive mechanical noise | Worn cylinder barrel (piston slap)<br>Worn small end bearing (rattle)<br>Worn big-end bearing (knock)<br>Worn main bearings (rumble) | Rebore and fit o/s piston.<br>Renew bearing and gudgeon pin.<br>Fit new big-end bearing.<br>Fit new journal bearings and seals. |
| Engine overheats and fades | Pre-ignition and/or weak mixture<br><br>Lubrication failure  | Check carburettor settings. Check also whether plug grade correct.<br>Is correct measure of oil mixed with petrol?              |

## 43 Fault diagnosis - clutch

| Symptom  | Reason/s                                 | Remedy   |
|--|--|--|
| Engine speed increases but machine does not respond  | Clutch slip                              | Check clutch adjustment for pressure on pushrod. Also free play at handlebar lever. Check condition of clutch plate linings, also free length of clutch springs. Renew if necessary. |
| Difficulty in engaging gears. Gear changes jerky and machine creeps forward, even when clutch is fully withdrawn | Clutch drag                              | Check clutch adjustment for too much free play.  |
|  | Clutch plates worn and/or clutch drum    | Check for burrs on clutch plate tongues or indentations in clutch drum slots. Dress with file.   |
|  | Clutch assembly loose on mainshaft       | Check tightness of retaining nut. If loose, fit new tab washer and retighten.  |
| Operation action stiff   | Damaged, trapped or frayed control cable | Check cable and replace if necessary. Make sure cable is lubricated and has no sharp bends.  |
|  | Bent pushrod                             | Renew.   |

## 44 Fault diagnosis - gearbox

| Symptom   | Reason/s   | Remedy                        |
|---|--|-------------------------------|
| Difficulty in engaging gears                                      | Pawl spring broken   | Renew.                        |
|   | Gear selector forks bent                                     | Renew.                        |
|   | Worn selector drum   | Renew.                        |
| Machine jumps out of gear   | Worn dogs on ends of gear pinions<br>Index arm spring broken | Renew worn pinions.<br>Renew. |
| Kickstarter does not return when engine is turned over or started | Broken or badly tensioned kickstarter return spring          | Renew.                        |
| Gear change lever does not return to normal position              | Broken return spring   | Renew.                        |

## Chapter 2 Fuel system and lubrication

### Contents

|  |   |
|--|---|
| General description ... .. 1                   | Carburettor - dismantling and inspection ... .. 7                       |
| Petrol/oil mix - correct ratio ... .. 2        | Carburettor - checking the settings ... .. 8                            |
| Petrol tank - removal and replacement ... .. 3 | Air cleaner - location, examination and replacement of element ... .. 9 |
| Petrol tap - removal and replacement ... .. 4  | Exhaust system - cleaning ... .. 10                                     |
| Petrol feed pipe - inspection ... .. 5         | Fault diagnosis - fuel system and lubrication ... .. 11                 |
| Carburettor - removal ... .. 6                 |   |

### Specifications

|                                |   |
|--------------------------------|---|
| Petrol tank capacity ... ..    | 1.6 gallons (6.0 litres)                                      |
| <b>Carburettor:</b>            |   |
| Type ... ..                    | VM 16 SC  |
| Main jet ... ..                | 150   |
| Needle jet ... ..              | W4  |
| Needle ... ..                  | 3G9 - 3   |
| Pilot jet ... ..               | 25  |
| Starter jet ... ..             | 50  |
| Throttle slide cut away ... .. | 1.5   |
| Air screw setting ... ..       | Back out 1½ turns   |
| Idling speed ... ..            | 1250 - 1350 rpm   |
| <b>Petrol/oil mixture:</b>     |   |
| Mixing ratio ... ..            | 20 parts of petrol to 1 part of oil (2/5 pint oil per gallon) |
| Oil ... ..                     | Self-mixing two stroke  |

#### 1 General description

The fuel system comprises a petrol tank from which a petrol/oil mix of controlled proportions is fed by gravity to the float chamber of the carburettor. A petrol tap with a built-in gauze filter is located beneath the rear end of the petrol tank, which has provision for turning on a small reserve quantity of fuel when the main content of the tank is exhausted.

For cold starting purposes a handlebar control operates a movable slide to give a rich mixture.

#### 2 Petrol/oil mix - correct ratio

1 Because the engine relies on the 'petrol' system for lubrication purposes, a measured amount of oil must always be added to the petrol. If a self-mixing oil is used, the proportion is one part of oil to twenty parts of petrol.

2 It will be realised that the lubrication of the engine is dependent solely on the intake of the fuel mixture from the

carburettor. In consequence, it is inadvisable to coast the machine down a long hill whilst the throttle is closed, otherwise there is risk of engine seizure through the temporary lack of lubrication.

3 The gearbox has its own supply of lubricating oil and is quite independent of the engine lubricating system. Two-stroke mixing oils must NEVER be used.

#### 3 Petrol tank - removal and replacement

1 It is unlikely that there will be need to remove the petrol tank completely unless the machine has been laid up and rust has formed inside or it needs reconditioning. The engine/gear unit can be removed from the frame without having to detach the tank. The ignition coil is mounted inside the frame and the tank has to be removed to gain access.

2 The petrol tank is supported by rubber buffers and is retained in place with the dualseat. There are four bolts fixing the dualseat to the machine and after the dualseat has been removed the rear of the petrol tank can be lifted and the tank slid off to the rear of the machine.



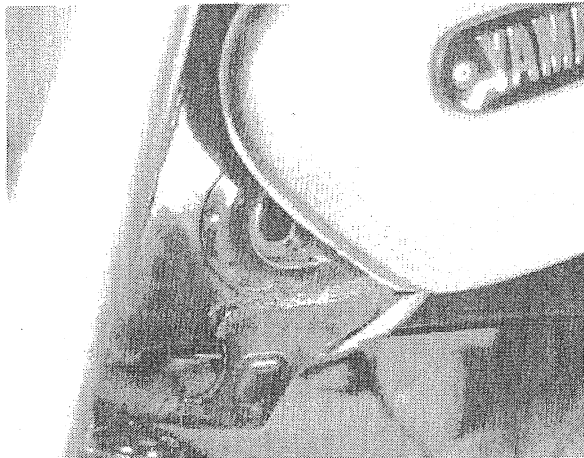

3.2a Rubbers on inside of tank engage with guides on frame

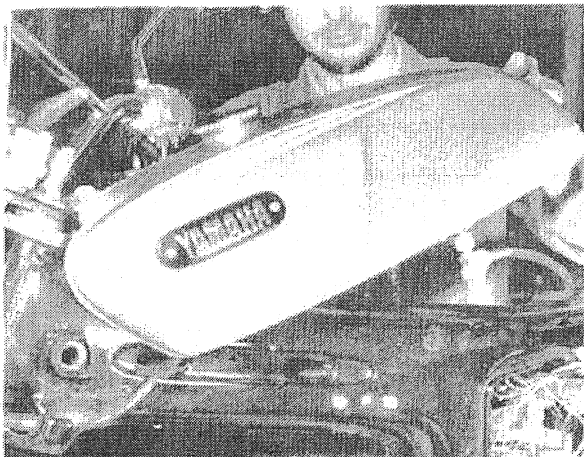

3.2b Lift rear end first when removing tank

3 To replace the tank reverse the procedure described in the preceding paragraph, after first ensuring that the front rubber buffers have slid into their correct positions.

#### 4 Petrol tap - removal and replacement

- 1 The petrol tap is a three position closed - open - reserve type fitted to the left hand side of the petrol tank.
- 2 Drain the tank or if only a small amount of fuel remains, lay it on its right hand side. Undo the union nut above the tap and it will withdraw from the tank.
- 3 To clean the filter, the bolt on the bottom of the tap must be removed allowing the bottom half of the tap to fall off, revealing the filter to be cleaned. There is no necessity to remove or drain the tank when cleaning the filter, provided the petrol is turned off.
- 4 To replace the filter and cap reverse the procedure in paragraphs 2 and 3.

#### 5 Petrol feed pipe - inspection

The petrol feed pipe is made of synthetic rubber and a check that it is not cracked or chafed should be made as leaking petrol can cause a fire. Ensure that the circlips on each end are present, in good condition and properly located.

#### 6 Carburettor - removal

##### Engine removed from machine

1 If the engine has already been removed from the machine, the carburettor will be attached to the control cables and tied up out of the way.

##### Engine still in machine

- 2 If the engine is still in the machine, the carburettor is on the right hand side of the engine, under the front cover.
- 3 Turn off the petrol.
- 4 Remove the four screws and right hand cover to reveal the carburettor.
- 5 Slide the rubber boot and spring retainer up the control cables and pull the petrol pipe off.
- 6 Remove the plastic bung from the front of the cover, insert a screwdriver in the hole and slacken off the carburettor clamp ring. Pull the carburettor off its stub.

#### 7 Carburettor - dismantling and inspection

- 1 At this stage, the carburettor is still attached to the control cables and to remove it completely the two small screws on the top of the carburettor must be undone. The top will come away complete with the throttle slide assembly and the choke slide.
- 2 To separate the float chamber, remove the screw from the bottom of the carburettor and gently pull off the float chamber, taking care not to damage the gasket or lose the O ring.
- 3 The carburettor float will stay in the float chamber when it is removed and can then be lifted or tipped out. Check the condition of the float and shake it to see if there is any petrol inside it. The float cannot be effectively repaired and if damaged, should be renewed. Make sure that the float chamber is clean and free from any sediment that may have originated from the petrol.
- 4 The float needle is situated inside the petrol pipe union and should be cleaned and checked for wear in the form of ridges in the conical portion of the end. Renew it if necessary.
- 5 The main jet is the smaller of the two brass hexagons on the underside of the carburettor body. It screws into the end of the needle jet and should be removed and cleaned by blowing or by screwing it into the end of a tyre pump and pumping it clear. Do not use pins or wire to clean it or the size and finish of the small hole will be affected.
- 6 The needle jet is the brass hexagon into which the main jet screws and should be removed for cleaning.
- 7 Clean the carburettor body and blow out the internal passages. Check for wear in the slide bores.
- 8 The throttle and air slide assemblies should be examined for wear. Check that the needle is straight and the return springs unbroken.
- 9 The air screw is the slotted screw on the front of the carburettor and can be unscrewed for cleaning.
- 10 When reassembling the carburettor, follow the dismantling instructions in reverse, ensuring that the small air pipe is refitted on its union on the front of the carburettor and the petrol overflow pipe on the side.

#### 8 Carburettor - checking the settings

- 1 The various sizes of the jets and the throttle slide, needle and needle jet are predetermined by the manufacturer and should not require modification. Check with the Specifications list if there is any doubt about the values fitted.
- 2 Slow running is controlled by a combination of the throttle stop and air screw. Commence by screwing in the air screw until it lightly seats then back it out 1½ complete turns. Next, adjust the throttle stop so that the engine idles at a steady tick-over.
- 3 As a rough guide, up to 1/8 throttle is controlled by the pilot jet, from 1/8 to ½ throttle by the throttle slide cutaway, from ½ to ¾ throttle by the needle position and from ¾ to full

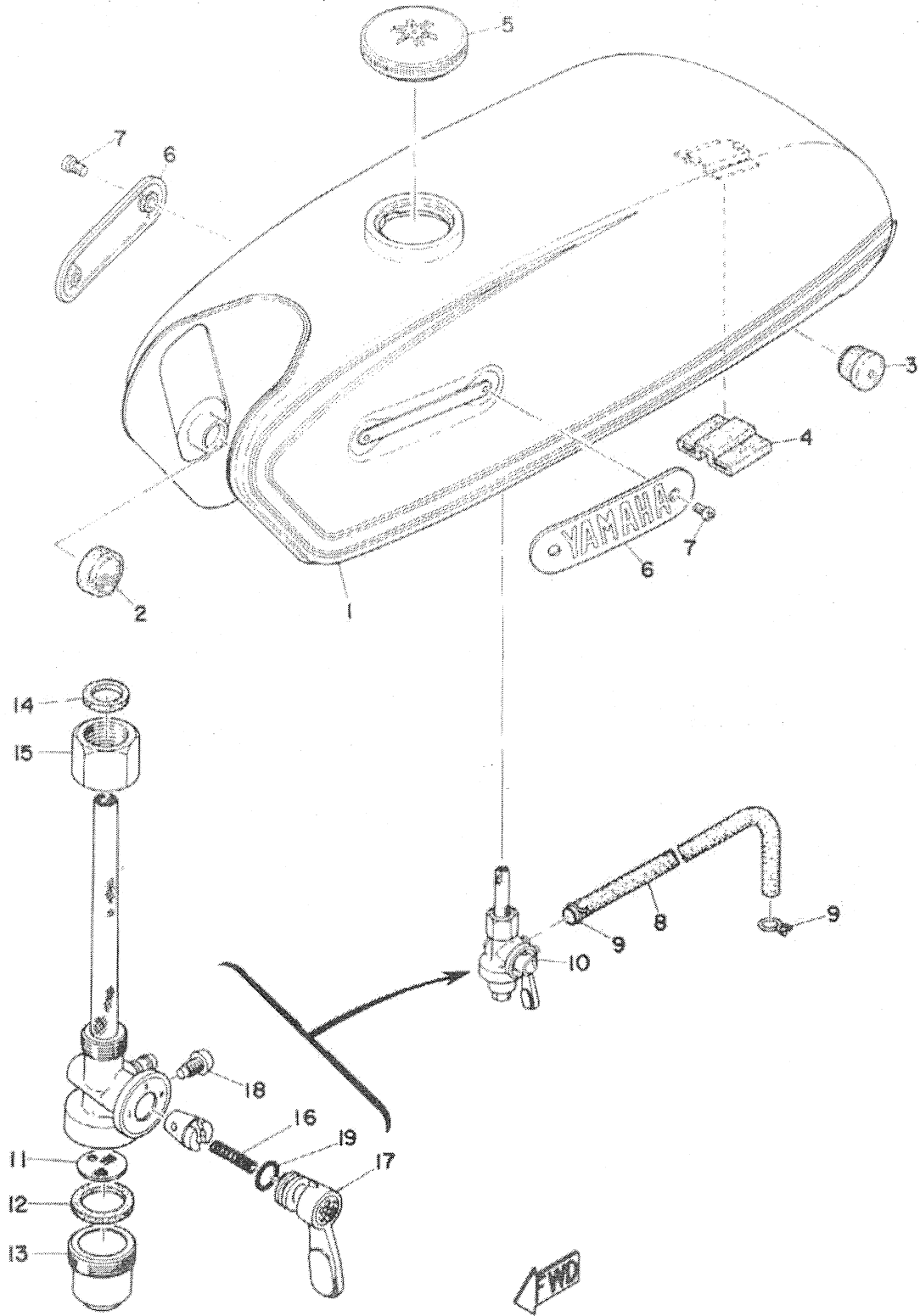

Fig. 2.1. Fuel tank

- |                           |                          |                      |                            |
|---------------------------|--------------------------|----------------------|----------------------------|
| 1 Fuel tank complete      | 6 Tank badges - 2 off    | 10 Fuel tap complete | 15 Union nut               |
| 2 Locating rubber - 2 off | 7 Panhead screw for tank | 11 Filter gauze      | 16 Tap lever spring        |
| 3 Locating rubber - 2 off | 8 Fuel pipe              | 12 Sealing washer    | 17 Tap lever               |
| 4 Locating rubber         | 9 Pipe clip - 2 off      | 13 Filter bowl       | 18 Tap lever fitting screw |
| 5 Filler cap              |                          | 14 Sealing washer    | 19 Seal for tap lever      |

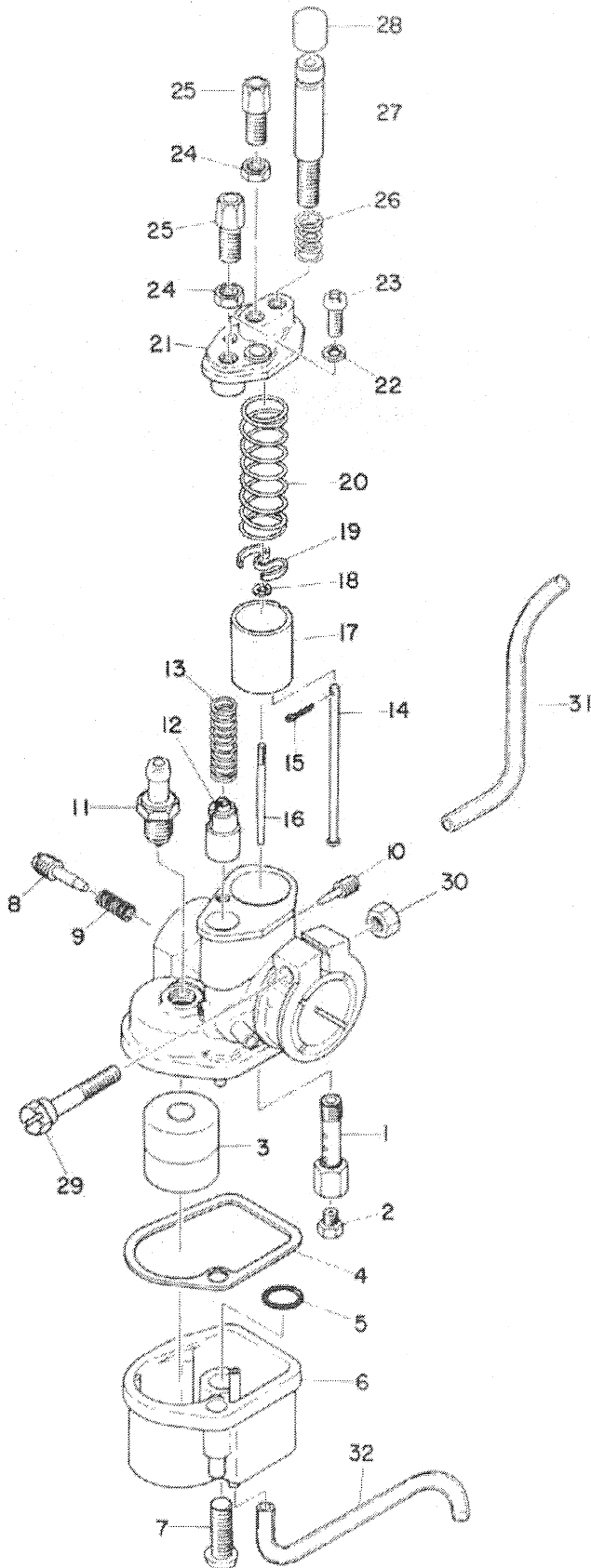
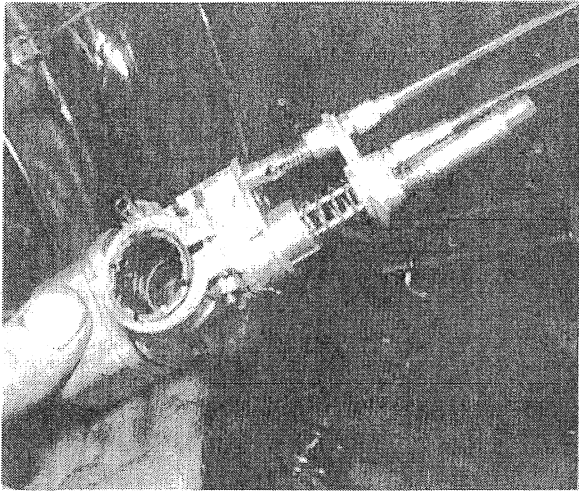
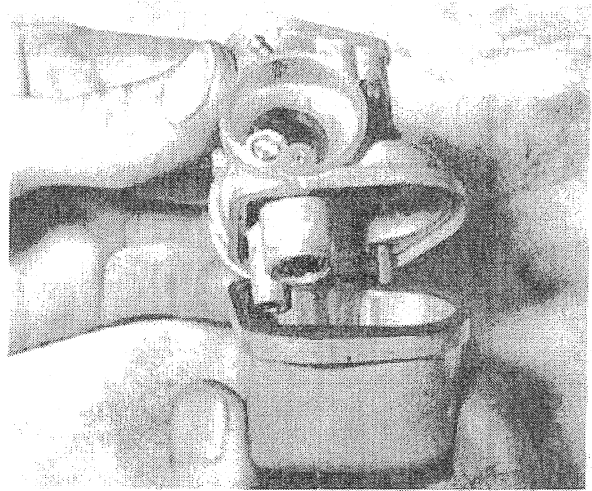

Fig. 2.2. Carburettor

- 1 Needle jet
- 2 Main jet (150 standard)
- 3 Float
- 4 Float chamber gasket
- 5 'O' ring for retaining screw
- 6 Float chamber body
- 7 Panhead screw for retaining float chamber
- 8 Air adjusting screw
- 9 Spring for air adjusting screw
- 10 Pilot jet
- 11 Float valve seating
- 12 Choke plunger
- 13 Plunger spring
- 14 Throttle slide rod
- 15 Split pin
- 16 Needle
- 17 Throttle valve (slide)
- 18 Needle clip
- 19 Spring seating
- 20 Throttle valve return spring
- 21 Mixing chamber top
- 22 Spring washer
- 23 Panhead screw for mixing chamber top
- 24 Cable adjuster nut
- 25 Cable adjuster
- 26 Throttle stop spring
- 27 Throttle stop screw
- 28 Cap for throttle stop screw
- 29 Screw for clamp
- 30 Nut for clamp
- 31 Air vent pipe
- 32 Overflow pipe



7.1 Throttle and air slide lift away with carburettor top



7.2 Release screw at base of carburettor to free float chamber

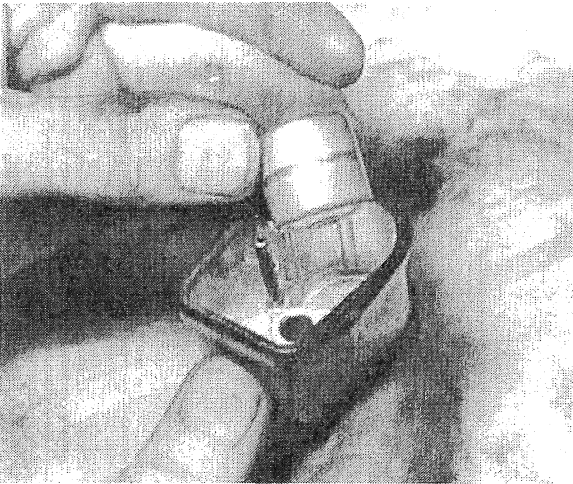

7.3 Float will remain in float chamber and will lift out

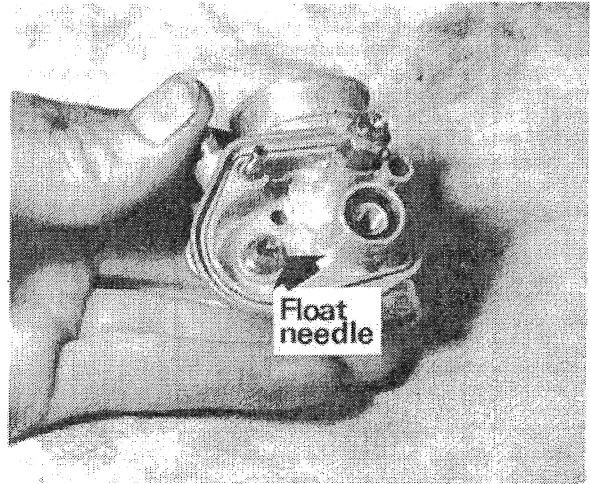

7.4 Float needle is within petrol feed union

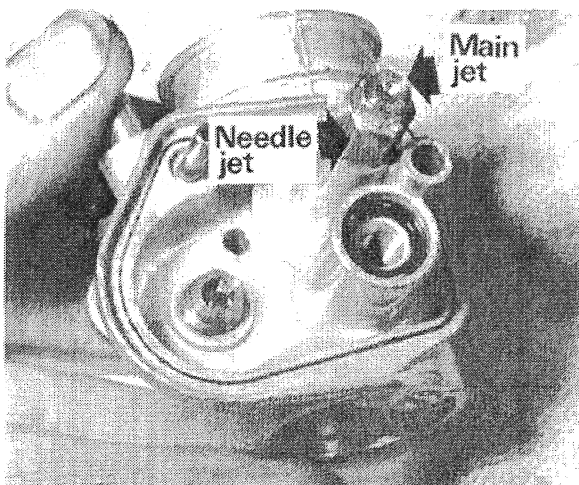

7.5 Main jet screws into base of needle jet

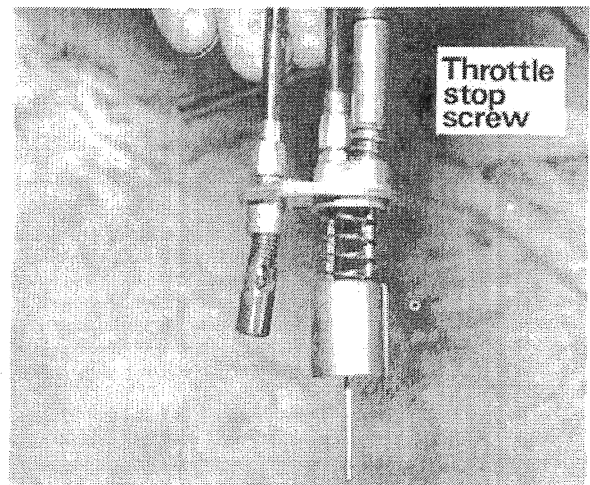

7.8 Examine throttle and air slide assembly for wear

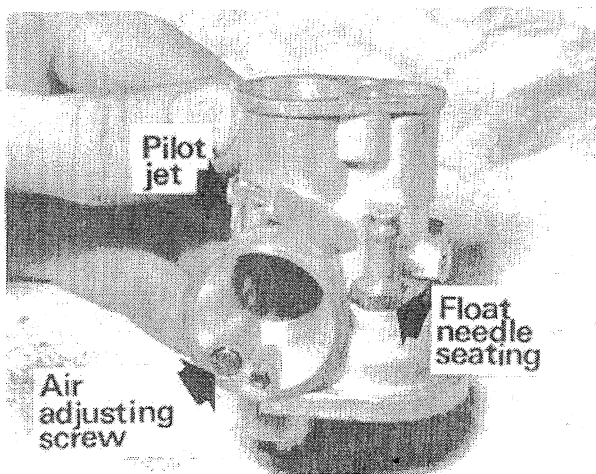

7.9 Air adjusting screw is close to carburettor intake

throttle by the size of the main jet. These are only approximate divisions; there is a certain amount of overlap.

4 The normal setting for the pilot jet screw is approximately one and three-quarter full turns out from the fully closed position. If the engine 'dies' at low throttle openings, suspect a blocked pilot jet.

5 Guard against the possibility of incorrect carburettor adjustments which result in a weak mixture. Two-stroke engines are very susceptible to this type of fault, which will cause rapid overheating and subsequent engine seizure. Some owners believe that the addition of a little extra oil to the petrol will help prolong the life of the engine, whereas in practice quite the opposite occurs. Because there is more oil the petrol content is less and the engine runs with a permanently weakened mixture!

#### 9 Air cleaner - location, examination and replacement of the element

1 The air cleaner is above the engine and to remove the filter element for cleaning the nut in the centre of the chrome endplate must be removed. The two endplates and centre rod can then be removed. The filter element will then pull clear of the air hose and will slide out.

2 To clean the filter element blow it with an air gun from the inside. As it is only made of paper it should be kept clear of water or oil. If the filter is torn or wet it should be renewed without question. A blocked or partially blocked air cleaner causes high petrol consumption.

#### 10 Exhaust system - cleaning

1 The exhaust system of any two-stroke engine requires quite frequent attention because the oily nature of the exhaust gases causes a build-up of sludge which will eventually partially block the system and cause serious back pressures. This will occur even more rapidly if the engine is in need of a rebore and is using oil.

2 The exhaust system is removed easily by following the procedure detailed in Chapter 1.5, paragraph 17. The baffle tube is removed by unscrewing the retaining screw and sliding out the baffle tube.

3 The exhaust pipe and silencer are one unit and if a large amount of carbon has built up inside it is necessary to fill the silencer with a solution of caustic soda after blocking up one end. If possible, leave the caustic soda solution within the silencer overnight before draining off and washing out thoroughly with water.

4 Caustic soda is highly corrosive and every care should be taken when mixing and handling the solution. Keep the solution

away from the skin and more particularly the eyes. The wearing of rubber gloves is advised whilst the solution is being mixed and used.

5 The solution is prepared by adding 3 lbs of caustic soda to 1 gallon of COLD water, whilst stirring. Add the caustic soda a little at a time and NEVER add the water to the chemical. The solution will become hot during the mixing process, which is why cold water must be used.

6 Make sure the used caustic soda solution is disposed of safely, preferably by diluting with a large amount of water. Do not allow the solution to come into contact with aluminium castings because it will react violently with this metal.

7 If the baffle assembly is heavily coated with a sludge of carbon and oil, it is permissible to burn this out with a blow lamp. Care should be taken that the felt of the baffle tube is not set alight.

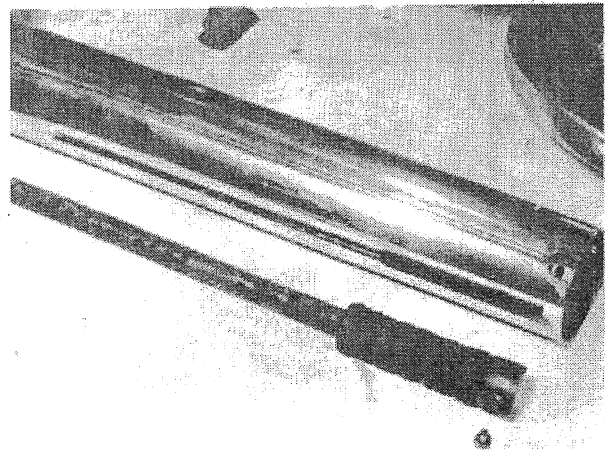

10.2. Single screw retains baffle tube assembly in silencer

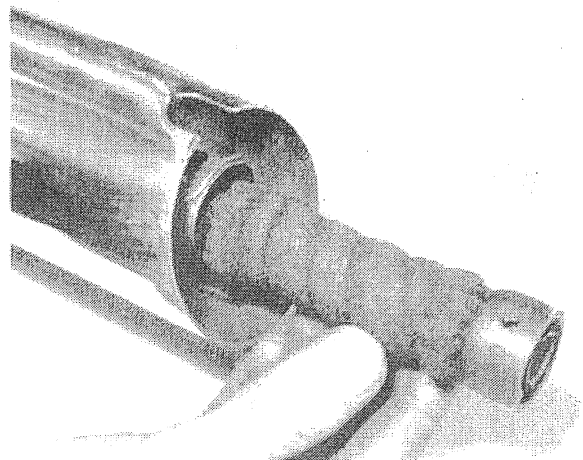

10.7 Avoid burning felt if blowlamp is used to burn out carbon

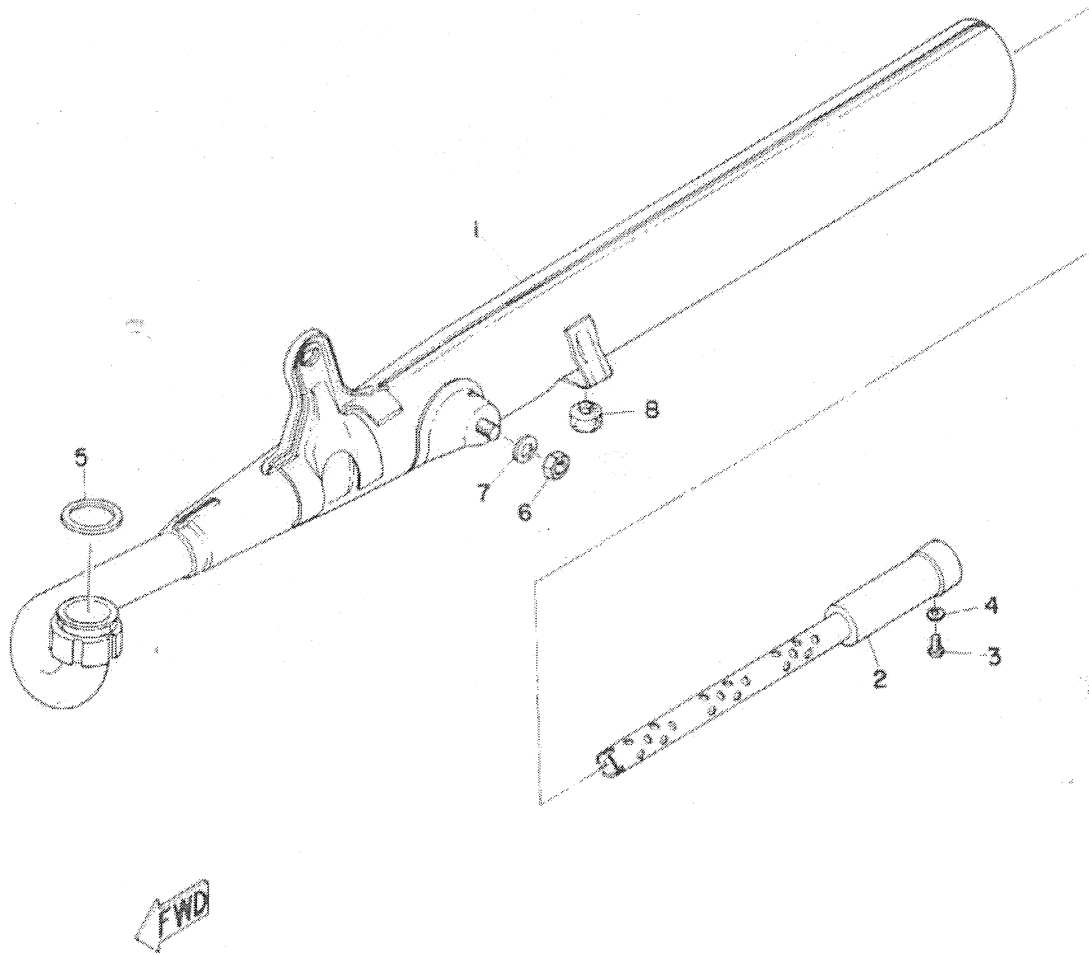

Fig. 2.3. Exhaust pipe and silencer

1 Exhaust assembly  
2 Baffle tube

3 Panhead screw for retaining  
baffle assembly

4 Spring washer  
5 Exhaust pipe gasket

6 Silencer mounting nut  
7 Spring washer  
8 Stop for centre stand

8 Never tamper with the exhaust system and remove the baffles from the silencer or fit a quite different system. Although a louder exhaust note may give the illusion of greater speed, in nearly every case performance will be reduced and the rider may risk prosecution. It is difficult to improve on the manufacturer's

original specification, which has been designed to match in with the characteristics of the engine. Speed and noise do not necessarily go hand in hand.

9 To reassemble the exhaust system reverse the dismantling procedure.

#### 11 Fault diagnosis - fuel system and lubrication

| Symptom                                     | Reason/s  | Remedy   |
|---|---|--|
| Excessive fuel consumption                  | Air cleaner choked or restricted<br>Fuel leaking from carburettor. Float sticking<br><br>Badly worn or distorted carburettor<br>Carburettor incorrectly adjusted<br>Incorrect silencer fitted to exhaust system | Clean or if paper element oily or wet renew.<br>Check all unions and gaskets. Float needle seat needs cleaning.<br>Renew.<br>Tune and adjust as necessary.<br>Do not deviate from manufacturer's original silencer design. |
| Idling speed too high                       | Throttle stop screw in too far. Carburettor top loose   | Adjust screw. Tighten top.   |
| Engine does not respond to throttle         | Back pressure in silencer. Float displaced or punctured<br>Use of incorrect silencer or baffles missing   | Check baffles in silencer. Check whether float is correctly located or has petrol inside.<br>See above. Do not run without baffles.  |
| Engine dies after running for a short while | Blocked air hole in filter cap<br>Dirt or water in carburettor  | Clean.<br>Remove and clean out.  |
| General lack of performance                 | Weak mixture; float needle stuck in seat<br>Air leak at carburettor joint or in crankcase   | Remove float chamber or float and clean.<br>Check joints to eliminate leakage.   |
| Excessive white smoke from exhaust          | Too much oil in petrol, or oil has separated out  | Mix in recommended ratio only. Mix thoroughly if mixing pump not available.  |

# Chapter 3 Ignition system

## Contents

|   |   |
|---|---|
| General description ... .. 1                  | Contact breaker points - removal, renovation & replacement ... .. 5 |
| Flywheel generator - checking output ... .. 2 | Condenser - removal and replacement ... .. 6                        |
| Ignition coil - checking ... .. 3             | Ignition timing ... .. 7  |
| Contact breaker adjustment ... .. 4           | Spark plug - checking and resetting gap ... .. 8                    |
|   | Fault diagnosis - ignition system ... .. 9                          |

## Specifications

### Flywheel generator:

|                                |                           |
|--------------------------------|---------------------------|
| Make ... ..                    | Mitsubishi or Hitachi     |
| Type ... ..                    | FA2 - IQL or FI - L40     |
| Output ignition winding ... .. | 150 - 300 V               |
| Max. gap for sparking ... ..   | 0.032 in. (8 mm)          |
| Contact breaker gap ... ..     | 0.012 in. (0.3 - 0.35 mm) |
| Capacitor rating ... ..        | 0.22 $\mu$ f $\pm$ 10%    |

### Ignition coil:

|               |                  |
|---------------|------------------|
| Make ... ..   | Mitsubishi       |
| Type ... ..   | HP - BI          |
| Output ... .. | 7,000 - 10,000 V |

### Spark plug:

|                                 |  |
|---------------------------------|--|
| Spark plug gap ... ..           | NGK B - 7HS  |
| Ignition timing fixed at ... .. | 0.020 in. - 0.024 in. (0.5 - 0.6 mm)                 |
|                                 | *0.071 in. $\pm$ 0.006 in. (1.8 $\pm$ 0.15 mm) bt/dc |

### 1 General description

The spark which is necessary to ignite the petrol/air mixture in the combustion chamber is derived from an ignition coil mounted on the frame and a generator attached to the left hand end of the crankshaft. A contact breaker assembly within the generator determines the exact moment at which the spark will occur; as the points separate the electrical circuit is interrupted and a high tension voltage is developed across the points of the spark plug which jumps the air gap and ignites the mixture.

### 2 Flywheel generator - checking output

The output from the flywheel generator can be checked only with specialised test equipment of the multi-meter type. It is unlikely that the average owner/rider will have access to this equipment or instruction in its use. In consequence, if the performance of the generator is suspect, it should be checked by a Yamaha agent or an auto-electrical expert.

### 3 Ignition coil - checking, removal and replacement

- 1 The ignition coil is a sealed unit, designed to give long service. If a weak spark and difficult starting cause its performance to be suspect, it should be tested by an auto-electrical expert. A faulty coil must be replaced; it is not practical to effect a repair.
- 2 To remove the coil the petrol tank must first be removed as described in Chapter 2.3. The coil is mounted inside the frame and is retained with two nuts. These must be removed and the coil pulled out carefully by the high tension lead. The coil holder is then removed by undoing the two retaining screws.
- 3 Reassembly is the reverse of the removal procedure.

### 4 Contact breaker - adjustment

- 1 To gain access to the contact breaker assembly, remove the two screws which hold the flywheel generator cover in position and lift off the cover. The contact breaker points can be viewed through one of the apertures in the flywheel rotor.
- 2 Rotate the engine until the contact breaker points are in the



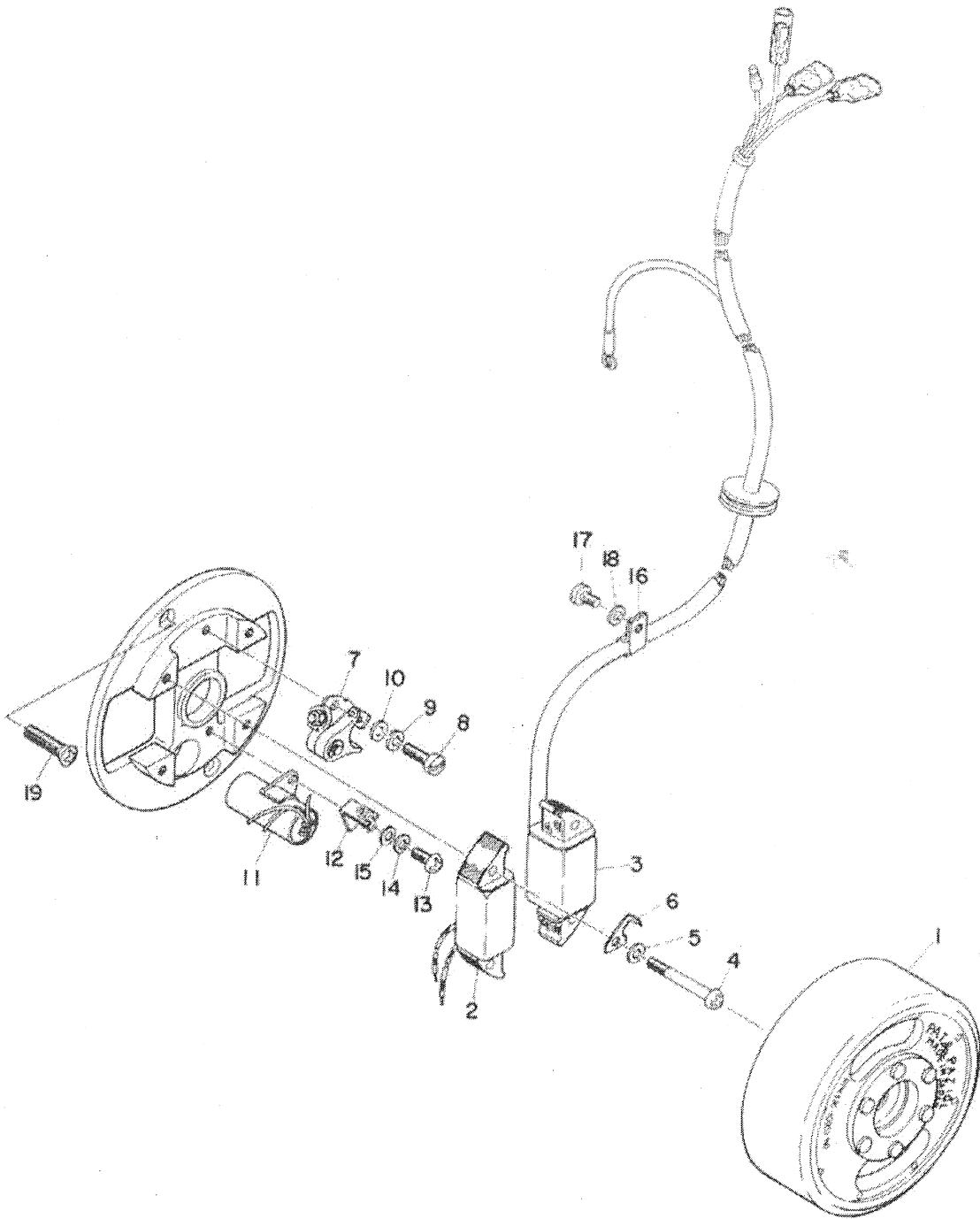

Fig. 3.1. Flywheel generator (Mitsubishi)

- |  |                            |                     |  |
|--|----------------------------|---------------------|--|
| 1 Rotor                                    | 5 Spring washer - 4 off    | 10 Plain washer     | 15 Plain washer                            |
| 2 Coil 1                                   | 6 Timing plate             | 11 Condenser        | 16 Cable clamp                             |
| 3 Coil 2 (lighting)                        | 7 Contact breaker assembly | 12 Lubricating wick | 17 Panhead screw for clamp                 |
| 4 Panhead screw for retaining coil - 4 off | 8 Panhead screw            | 13 Panhead screw    | 18 Spring washer                           |
|  | 9 Spring washer            | 14 Spring washer    | 19 Flathead screw for stator plate - 2 off |

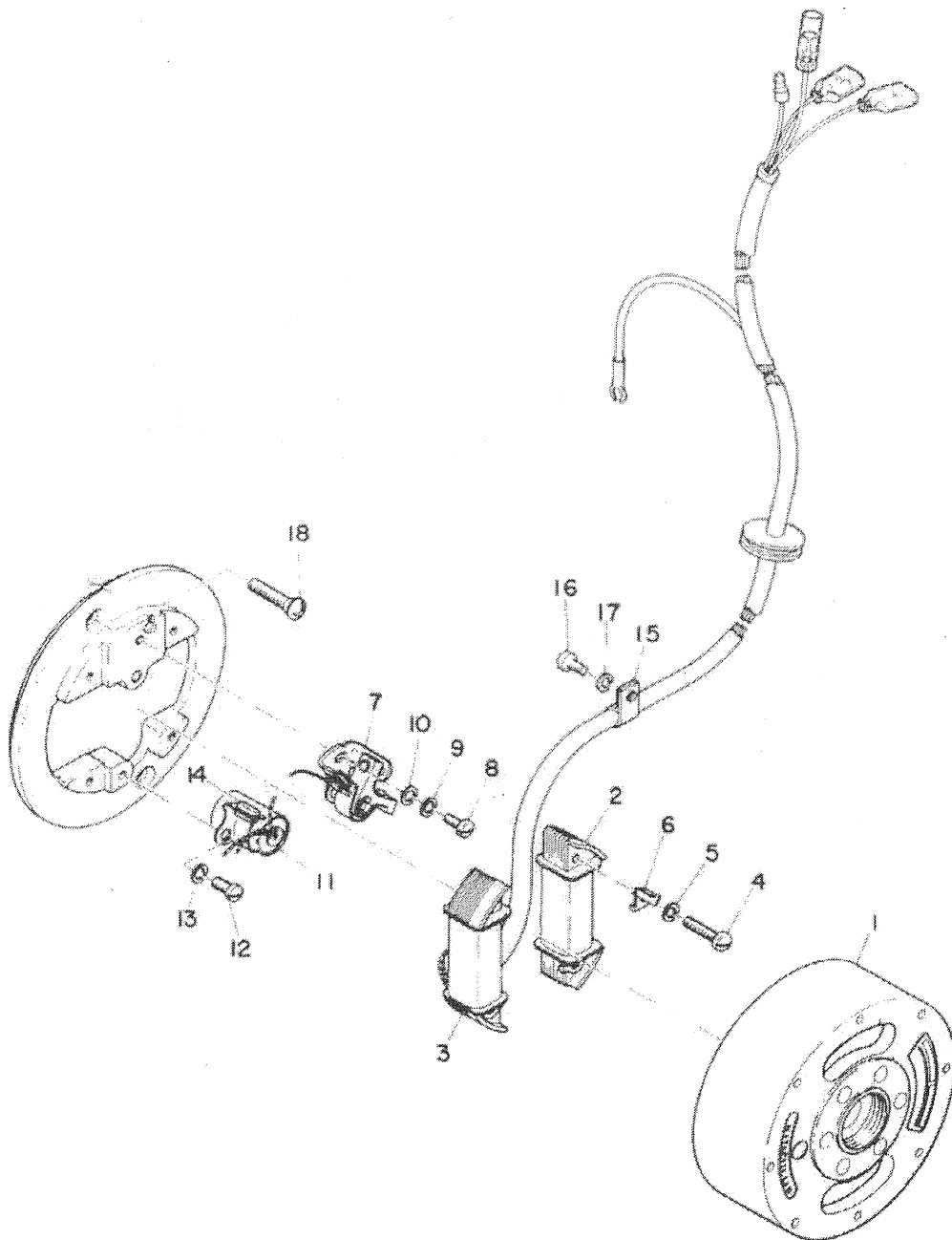
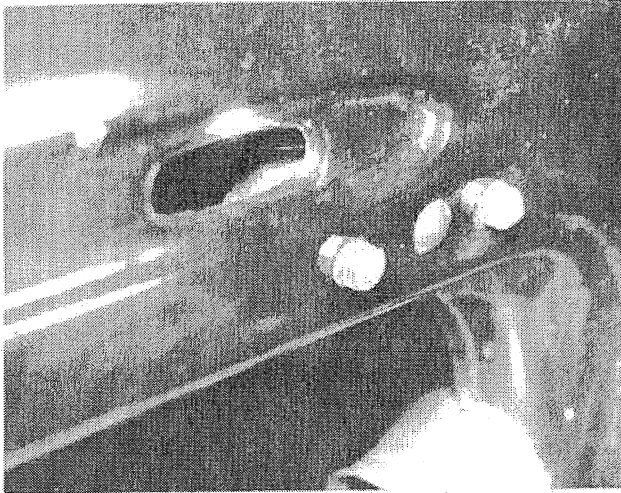

Fig. 3.2. Flywheel generator (Hitachi) (alternative equipment)

- |  |                            |                     |  |
|--|----------------------------|---------------------|--|
| 1 Rotor                                    | 5 Spring washer - 4 off    | 10 Plain washer     | 15 Cable clamp                             |
| 2 Coil 1                                   | 6 Timing plate             | 11 Condenser        | 16 Panhead screw for cable clamp           |
| 3 Coil 2 (lighting)                        | 7 Contact breaker assembly | 12 Panhead screw    | 17 Spring washer                           |
| 4 Panhead screw for retaining coil - 4 off | 8 Panhead screw            | 13 Spring washer    | 18 Flathead screw for stator plate - 2 off |
|  | 9 Spring washer            | 14 Lubricating wick |  |



3.2 Ignition coil is housed within frame and retained by two nuts

fully open position. Examine the faces of the contacts. If they are pitted or burnt it will be necessary to remove them for further attention, as described in Section 6 of this Chapter.

3 The correct contact breaker gap, when the points are fully open, is 0.012 inch (0.3 mm). Adjustment is effected by slackening the screw which clamps the fixed contact point in position and moving the contact nearer or further away, as the case may be, by levering against the timing plate. Make sure that the points are open fully when this adjustment is made, otherwise a false reading will result. Tighten the screw and check again.

#### 5 Contact breaker points - removal, renovation and replacement

1 If the contact breaker points are burned, pitted or badly worn, they should be removed for dressing. If it is necessary to remove a substantial amount of material before the faces can be restored, new replacements should be fitted.

2 It is necessary first to withdraw the flywheel magneto rotor before access can be gained. Instructions for the removal of the rotor are given in Chapter 1, Section 7. The fixed contact is removed by withdrawing the screw which holds the assembly to the stator plate of the generator. The moving contact is detached by releasing the circlip from the end of the pivot pin and by freeing the leaf return spring from its point of attachment close to the lower coil.

3 The points should be dressed with an oilstone or fine emery cloth. Keep them absolutely square during the dressing operation, otherwise they will make angular contact when they are replaced and will burn away rapidly as a result.

4 Replace the contacts by reversing the dismantling procedure. Take particular care to replace any insulating washers in their correct sequence, otherwise the points will be isolated electrically and the ignition system will not function. Lightly grease the pivot pin before the moving contact is replaced and check that there is no oil or grease on the surfaces of the points.

5 Replace the flywheel rotor after greasing the internal contact breaker cam. It is also advisable to add a few drops of light oil to the lubricating wick which rubs on the contact breaker cam, if the wick has a dry appearance.

6 Re-adjust the contact breaker gap after the flywheel rotor has been locked in position and the centre retaining bolt tightened fully to the recommended torque wrench setting of 25.5 lb ft.

#### 6 Condenser - removal and replacement

1 A condenser is included in the contact breaker circuitry to

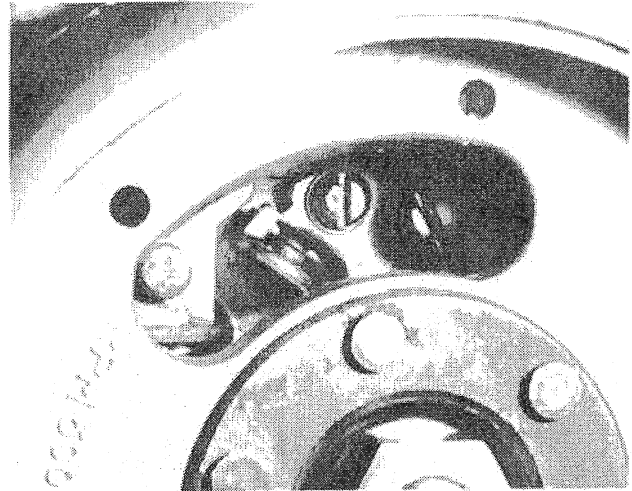

4.1 Access to points is through aperture in rotor

prevent arcing across the contact breaker points as they separate. It is connected in parallel with the points and if a fault develops, ignition failure will occur.

2 If the engine is difficult to start, or if misfiring occurs, it is possible that the condenser is at fault. To check whether the condenser has failed, remove the flywheel magneto cover and observe the points whilst the engine is running. If excessive sparking occurs across the points and they have a blackened or burnt appearance, it may be assumed the condenser is no longer serviceable.

3 The condenser is attached to the stator plate and it is first necessary to withdraw the flywheel rotor as described in Chapter 1, Section 7.

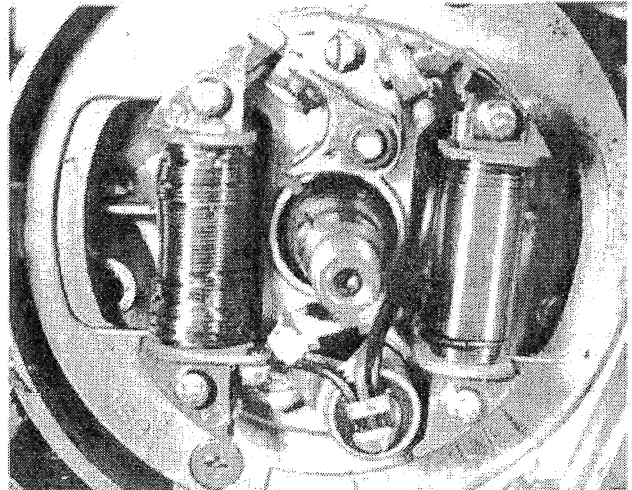

6.3 Condenser is attached to the stator plate

4 Before the condenser can be removed from the stator plate, it is necessary to unsolder the contact breaker and ignition coil leads. The retaining screw can then be removed and the condenser and wick holder will pull clear.

5 Fit the new condenser and the wick holder and retain them with the screw. Resolder the leads onto the new condenser.

6 Replace the flywheel rotor and lock it in position before tightening the centre retaining nut. Complete the reassembly by fitting the flywheel cover.

**7 Ignition timing**

The ignition timing is fixed at 0.071 inch (1.8 mm) before top dead centre when the contact breaker points are set at 0.012 inch (0.3 mm) and cannot be altered.

**8 Spark plug - checking and resetting the gap**

- 1 An NGK B-7HS plug is fitted as standard equipment to the Yamaha.
- 2 The spark plug has a 14 mm thread. The recommended gap is 0.020 - 0.024 inch (0.5 - 0.6 mm). Always use the grade of plug recommended or the exact equivalent in another manufacturer's range.
- 3 Check the spark plugs gap every six months or 1000 miles, whichever is soonest. To reset the gap, bend the outer electrode to bring it closer to the central electrode, otherwise the insulator will crack, causing engine damage if particles fall in whilst the engine is running.
- 4 Always carry a spare spark plug in the tool kit, wrapped so

that the electrodes cannot become bent or dirt enter the electrode area. Two-stroke engines are more susceptible to plug troubles and may on occasion cause plug fouling or whiskering. A spare plug will enable the engine to be restarted promptly in the event of trouble, which invariably occurs at an ill-timed moment.

5 The condition of the spark plug electrodes and insulator can be used as a reliable guide to engine operating conditions. See accompanying diagrams.

6 Never overtighten a spark plug, otherwise there is danger of stripping the threads from the cylinder head, particularly those cast in light alloy. The plug should be sufficiently tight to seat firmly on copper sealing washer. Use a spanner which is a good fit, otherwise the spanner may slip and break the ceramic insulator.

7 If the thread within the cylinder head does strip, it can be repaired permanently and economically by the use of a Helicoil thread insert. Many dealers have facilities for effecting this type of repair at a fraction of the cost of a replacement cylinder head.

8 Make sure that the plug insulating cap is a good fit. This cap contains the suppressor which eliminates radio and TV interference.

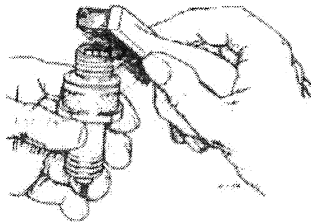

*Cleaning deposits from electrodes and surrounding area using a fine wire brush.*

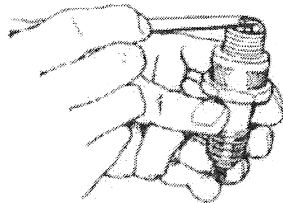

*Checking plug gap with feeler gauges*

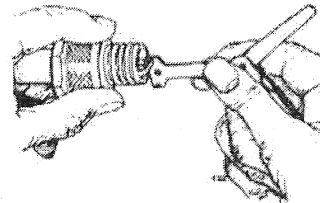

*Altering the plug gap. Note use of correct tool.*

**Fig. 3.3a. Spark plug maintenance**

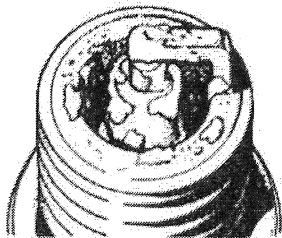

*White deposits and damaged porcelain insulation indicating overheating*

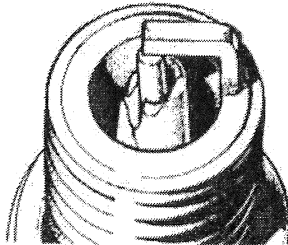

*Broken porcelain insulation due to bent central electrode*

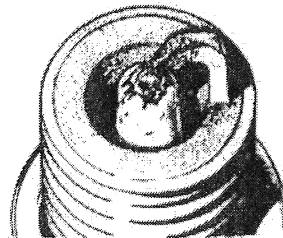

*Electrodes burnt away due to wrong heat value or chronic pre-ignition (pinking)*

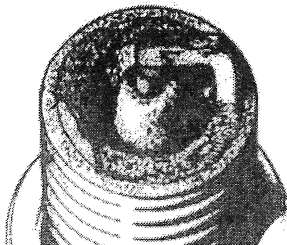

*Excessive black deposits caused by over-rich mixture or wrong heat value*

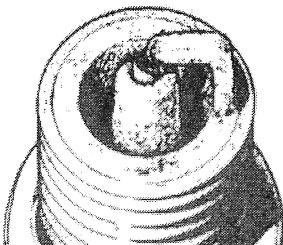

*Mild white deposits and electrode burnt indicating too weak a fuel mixture*

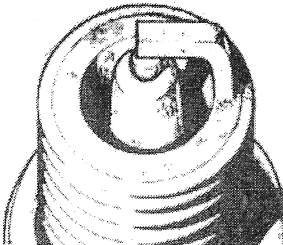

*Plug in sound condition with light greyish brown deposits*

**Fig. 3.3b. Spark plug electrode conditions**

## 9 Fault diagnosis - ignition system

| Symptom                            | Reason/s                   | Remedy  |
|------------------------------------|----------------------------|---|
| Engine will not start              | No spark at plug           | <p>Try replacement plug if gap correct.</p> <p>Check whether contact breaker points are opening and closing, also whether they are clean.</p> <p>Check whether points arc when separated. If so, replace condenser.</p> <p>Check ignition switch and coil.</p>  |
| Engine starts but runs erratically | Intermittent or weak spark | <p>Try replacement plug. Check whether points are arcing. If so, replace condenser.</p> <p>Check accuracy of ignition timing.</p> <p>Low output from flywheel magneto generator or imminent breakdown of ignition coil.</p> <p>Plug has whiskered. Fit replacement.</p> <p>Plug lead insulation breaking down. Check for breaks in outer covering, particularly near frame.</p> |

# Chapter 4 Frame and forks

## Contents

|   |    |  |    |
|---|----|--|----|
| General description ... ..                                    | 1  | Swinging arm rear suspension - examination and renovation ... .. | 11 |
| Front forks - removal from frame ... ..                       | 2  | Rear suspension units - examination ... ..                       | 12 |
| Front forks - dismantling ... ..                              | 3  | Centre stand - examination ... ..                                | 13 |
| Front forks - general examination ... ..                      | 4  | Speedometer - removal and replacement ... ..                     | 14 |
| Front forks - examination and replacement of oil seals ... .. | 5  | Speedometer cable - examination and renovation ... ..            | 15 |
| Front forks - examination and replacement of bushes ... ..    | 6  | Dual seat - removal ... ..                                       | 16 |
| Steering head bearings - examination and replacement ... ..   | 7  | Steering head lock ... ..  | 17 |
| Front forks - reassembly ... ..                               | 8  | Cleaning - general ... ..  | 18 |
| Frame assembly - examination and renovation ... ..            | 9  | Fault diagnosis - frame and forks assembly ... ..                | 19 |
| Swinging arm rear suspension - removal from frame ... ..      | 10 |  |    |

### 1 General description

The frame is of the spine type with swinging arm rear suspension controlled by two hydraulically damped suspension units. The front fork assembly comprises spring loaded fork tubes of the telescopic variety.

Repairs to the frame are limited to replacement of the parts which are subject to wear. The frame is constructed from pressed sheet metal and it is not economically feasible to repair accident damage in view of the low cost of a replacement.

### 2 Front forks - removal from frame

- 1 It is extremely unlikely that the front forks will need to be removed from the frame as a unit unless the steering head bearings give trouble or the forks are damaged in an accident.
- 2 Commence operations by placing the machine on the centre stand.
- 3 Slacken the front brake cable and disconnect it from the brake. Open the cable clip on the bottom yoke and remove the cable. Disconnect the cable from the handlebars and hang it up for the routine oiling procedure.
- 4 Remove the circlip retaining the speedometer cable in the brake plate and pull the cable clear. Unhook the cable from the clip and unscrew it from the speedometer head.
- 5 Undo the front wheel spindle nut and withdraw the wheel spindle. Support the machine to stop it from toppling forward.
- 6 The front wheel will now drop from the forks. Remove the spacer on the left hand side of the wheel to avoid it being lost.
- 7 Remove the bolts and washers from the top of the fork legs which will allow the speedometer and its bracket to be removed.
- 8 Slacken the screw on the bottom of the headlamp and prise off the headlamp rim.
- 9 Disconnect the wires to the headlamp bulb, the horn and the front indicators and place the reflector unit in a safe place.
- 10 Unscrew the nuts inside the headlamp shell and remove the

indicators. The headlamp shell will then rest on the bottom yoke.

11 The handlebars can be lifted clear once the bolts and half clamps have been removed.

12 Undo the bolt in the centre of the steering head stem and remove the washer and top yoke.

13 A large slotted nut is revealed and before this is unscrewed provision should be made to catch the uncaged ball bearings. There is a total of 38, 19 in each race.

14 Unscrew the large slotted nut whilst supporting the forks in position, remove the dust cover and the cone of the top race. The ball bearing can then be removed either with a magnet or a greased screwdriver.

15 As the forks are lowered the balls in the lower race will be displaced and once these have been collected the fork assembly can be pulled clear of the frame.

16 If further dismantling is necessary the front mudguard can be removed, when the forks have been withdrawn, by undoing the four retaining bolts.

17 The headlamp brackets can also be slid off the fork legs.

### 3 Front forks - dismantling

- 1 If only the fork legs are to be removed without disturbing the head races, follow the instructions in the previous heading as far as paragraph 7, and include paragraph 6. Then continue as follows:
- 2 To remove the fork legs, unscrew the pinch bolts in the fork bottom yoke. The fork legs should now pull clear. If they are still a tight fit, spring open the pinch bolt joint a little.
- 3 The O ring in the top of the fork leg should be removed to avoid its being lost and the oil drained out of the leg.
- 4 The rubber gaiter can now be slid off the fork leg with the spring inside it. The spring can easily be pulled out of the gaiter for checking or replacing.
- 5 The spring guide and register can be slid off the fork leg.
- 6 Unscrew the screwed coil and remove it. This will allow

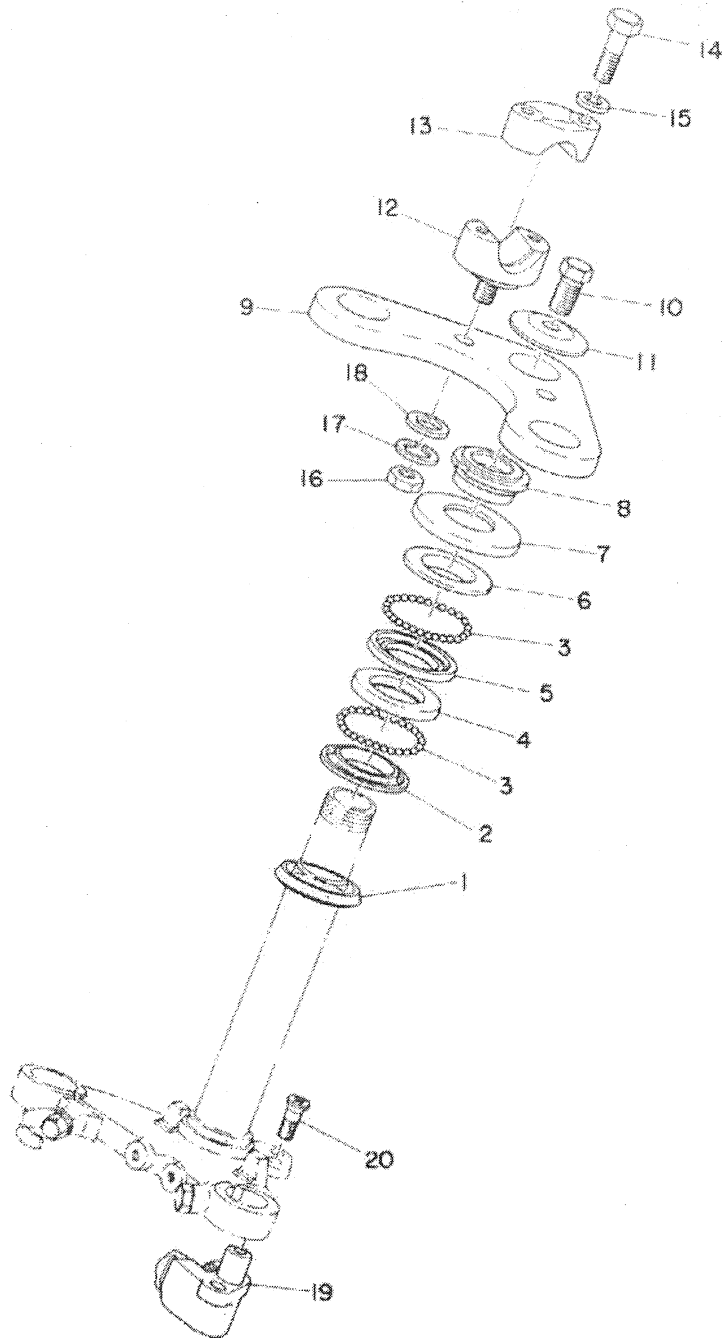

Fig. 4.1. Steering head assembly

- |                             |                             |                            |                            |
|-----------------------------|-----------------------------|----------------------------|----------------------------|
| 1 Dust seal                 | 6 Upper cone                | 12 Lower handlebar clamp   | 16 Clamp mounting nut      |
| 2 Lower cone                | 7 Dust cover                | - 2 off                    | - 2 off                    |
| 3 Ball bearing (1/4 inch) - | 8 Adjusting nut             | 13 Upper handlebar clamp - | 17 Spring washer - 2 off   |
| 38 off                      | 9 Top fork yoke             | 2 off                      | 18 Plain washer - 2 off    |
| 4 Lower cup                 | 10 Top fork bolt - 2 off    | 14 Clamp bolt - 4 off      | 19 Steering column lock    |
| 5 Upper cup                 | 11 Fork bolt washer - 2 off | 15 Spring washer - 4 off   | 20 Ovalhead screw for lock |



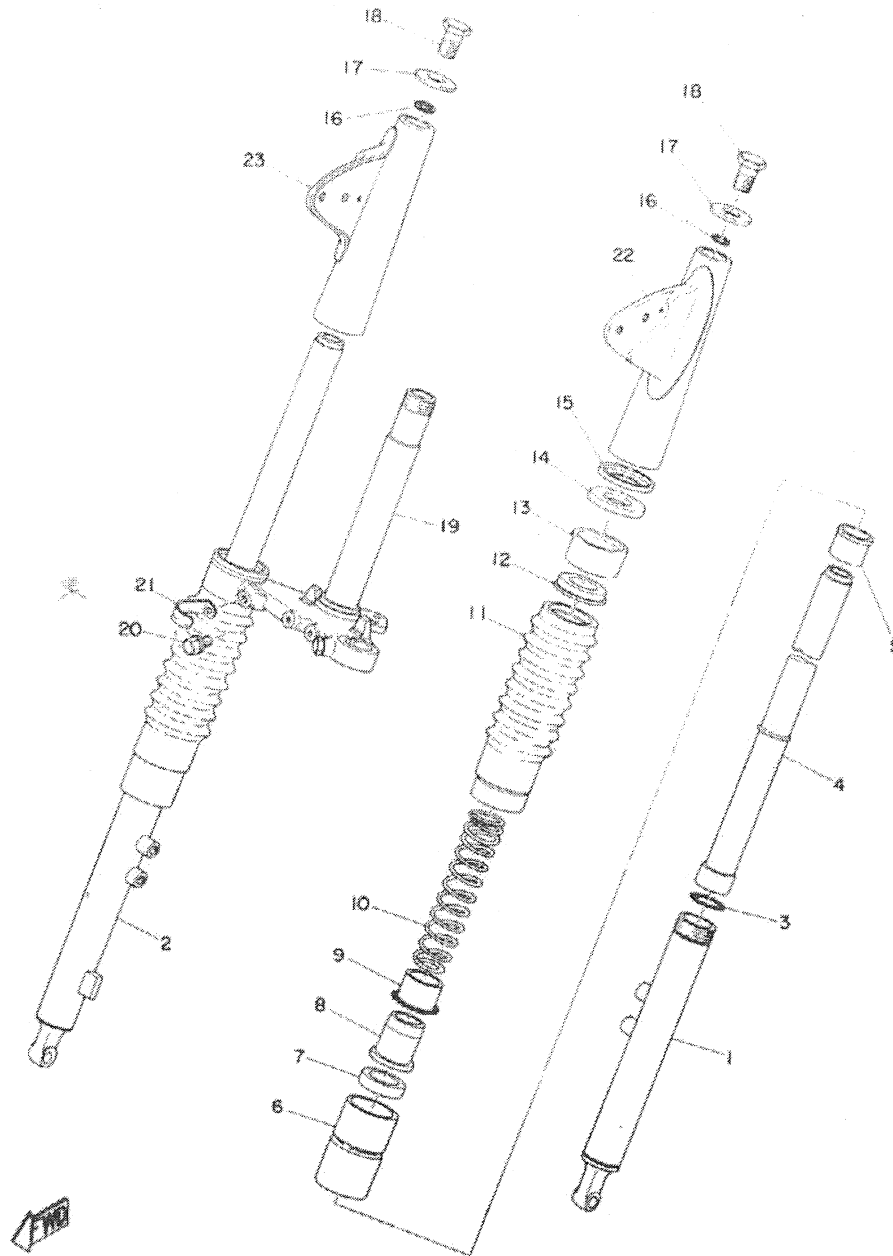

Fig. 4.2. Front forks

- |                               |                               |  |                                  |
|-------------------------------|-------------------------------|--|----------------------------------|
| 1 Lower fork leg - left-hand  | 6 Screwed collar - 2 off      | 12 Fork spring seating - upper - 2 off | 18 Fork cap - 2 off              |
| 2 Lower fork leg - right-hand | 7 Oil seal - 2 off            | 13 Outer cover - 2 off                 | 19 Head stem complete            |
| 3 'O' ring - 2 off            | 8 Fork spring seating - ? off | 14 Packing piece - 2 off               | 20 Lower yoke pinch bolt - 2 off |
| 4 Stanchion - 2 off           | 9 Spring guide - 2 off        | 15 Top cover guide - 2 off             | 21 Cable clamp                   |
| 5 Upper fork bush - 2 off     | 10 Fork spring - 2 off        | 16 'O' ring seal - 2 off               | 22 Top cover - left-hand         |
|                               | 11 Gaiter - 2 off             | 17 Fork cap washer - 2 off             | 23 Top cover - right-hand        |



the inner stanchion to be pulled out of the fork leg which will pull the bush out of the fork leg. The bush can then be slid off the stanchion.

7 An O ring is fitted on the fork leg below the thread which can now be removed.

#### 4 Front forks - general examination

1 Apart from the oil seals and bushes, it is unlikely that the forks will require any additional attention unless the fork springs are weak or if the fork legs or yokes have been damaged in an accident.

2 Visual examination will show whether the fork yokes are distorted or if the inner fork tubes are bent. It is rarely possible to effect a satisfactory repair and replacement is strongly recommended.

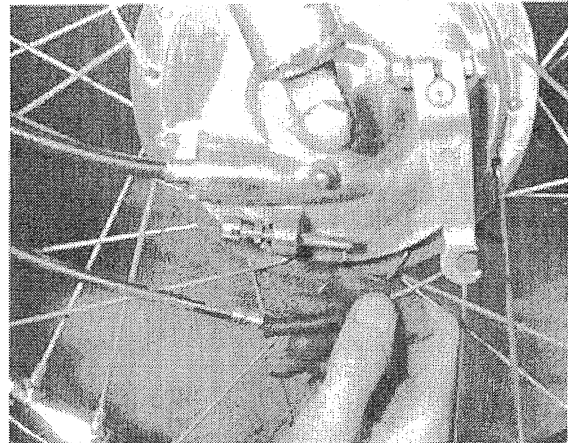

2.3 Disconnect cable from front brake operating arm

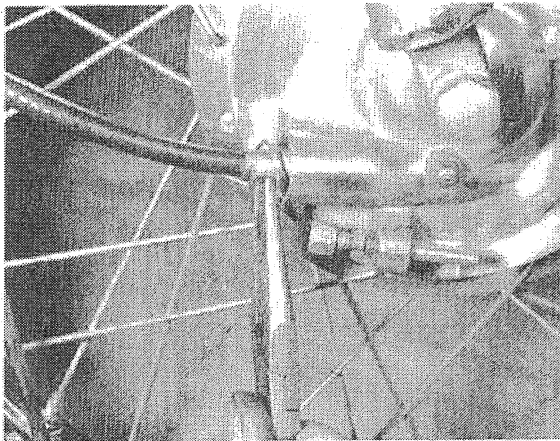

2.4a Remove circlip retaining speedometer drive cable and ...

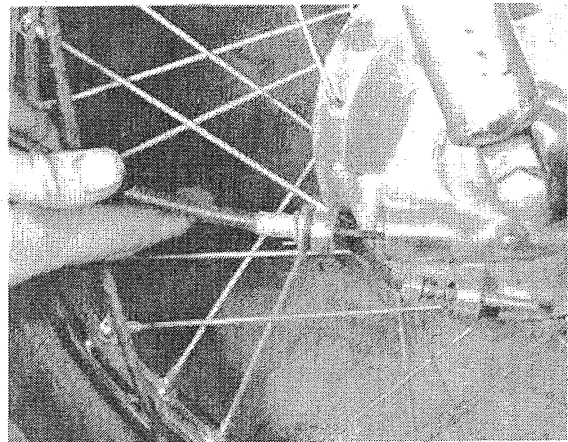

2.4b ... pull cable from housing to disconnect drive

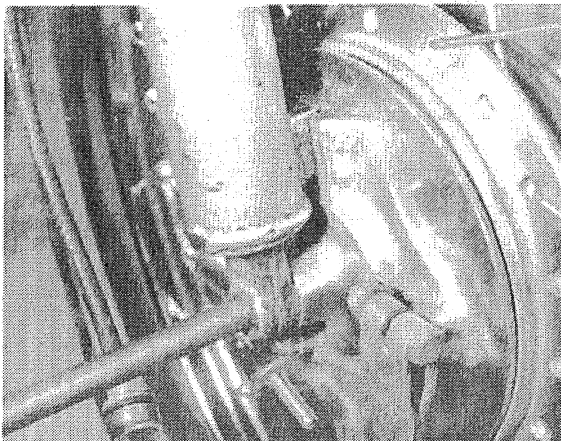

2.5 Front wheel spindle will pull out

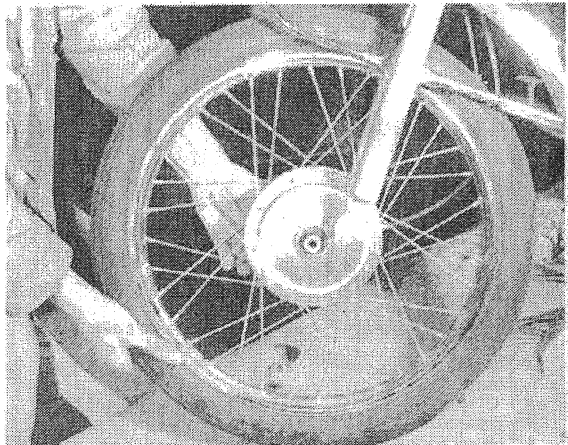

2.6 Front wheel is now free to be taken away

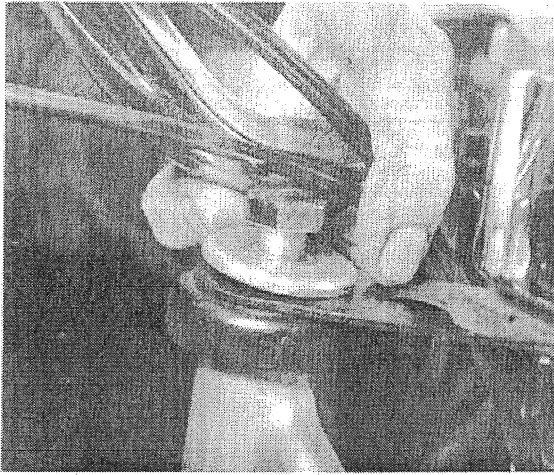

2.7 Remove bolts and washers from top of each fork leg



2.9 Disconnect wires within headlamp shell

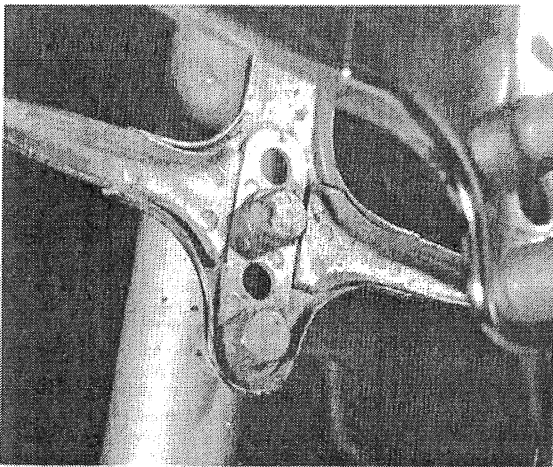

2.16 Front mudguard is bolted to inside of each fork leg

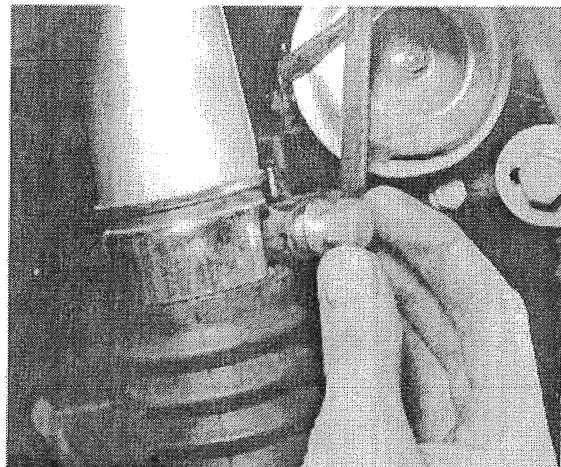

3.2 Remove pinch bolt from lower fork yoke



3.3 Remove 'O' ring from top of fork leg

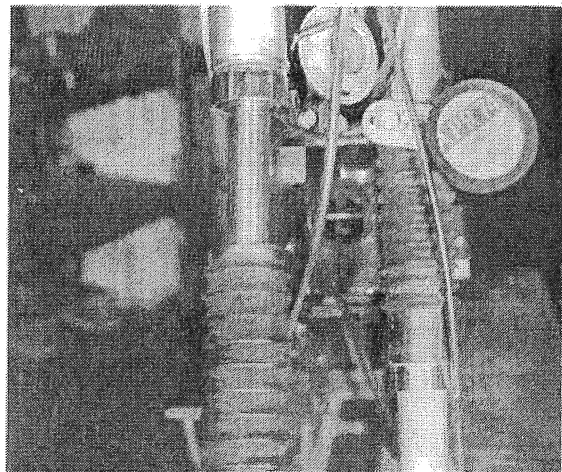

3.4 Slide off rubber gaiter with spring within

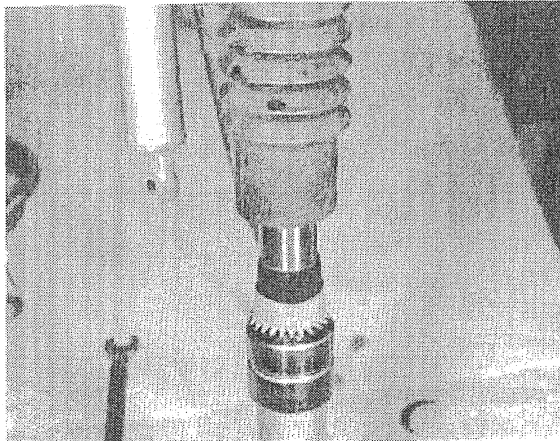

3.5 Fork spring guide and register will slide off fork leg

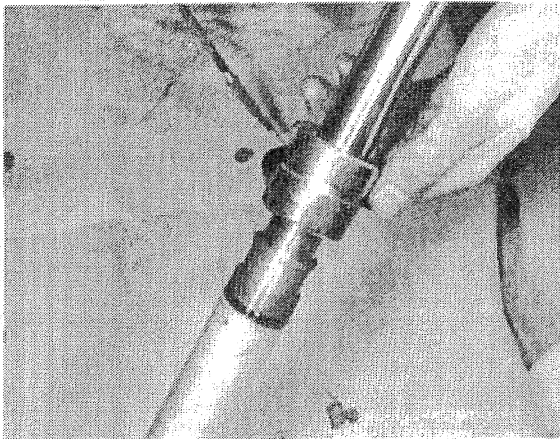

3.6a Unscrew plated collar and then ...

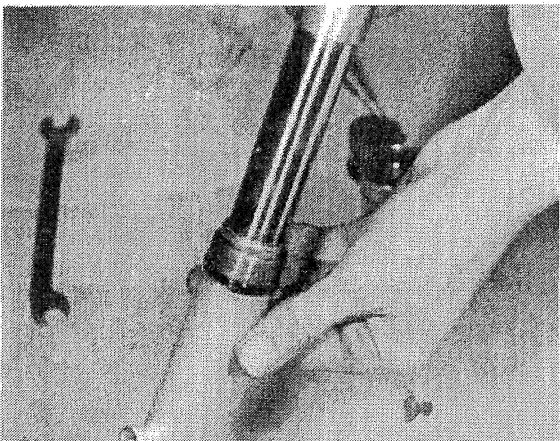

3.6b ... pull stanchion from lower fork leg

#### 5 Front forks - examination and replacement of oil seals

- 1 If the fork legs have shown a tendency to leak oil or if there is any other reason to suspect the condition of the oil seals, now is the time to replace them.
- 2 The oil seals fitted to the plated cups are displaced quite easily by pushing them out of the cup. Note that the seals will be destroyed during removal, so new replacements are essential.
- 3 It is advisable to replace the O rings at the same time.
- 4 When fitting the replacement seals, coat the underside with jointing compound and enter each seal squarely into the holder with the 'open' side facing downward (closest to front wheel spindle). Complete the operation whilst the jointing compound is still wet.

#### 6 Front forks - examination and replacement of bushes

- 1 Some indication of the extent of wear of the fork bushes can be gained before the machine is dismantled. If the front wheel is gripped between the knees and the handlebars rocked to and fro, the amount of wear will be magnified by the leverage at the handlebar ends. Cross-check by applying the front brake and pulling and pushing the machine backward and forward.
- 2 As the bottom bearing diameter is an integral part of the stanchion if there is any appreciable wear on this diameter or if there are any score marks on the stanchion then it must be renewed.
- 3 The bottom bearing diameter of the stanchion slides inside the fork leg. Check the inside of the fork leg and the top bearing bush for wear or score marks and replace if necessary. It is not practical to hone out the fork legs or bushes as oversize stanchions are not available.

#### 7 Steering head bearings - examination and replacement

- 1 Before commencing to reassemble the forks, inspect the steering head races. The ball bearing tracks should be polished and free from indentations and cracks. If signs of wear or damage are evident, the cups and cones must be replaced. They are a tight press fit and need to be drifted out of position.
- 2 Ball bearings are cheap. Each race contains nineteen  $\frac{1}{4}$  inch balls which should be replaced without question if the originals are marked or discoloured. To hold the ball bearings in place whilst the forks are re-attached, pack the bearings with grease.

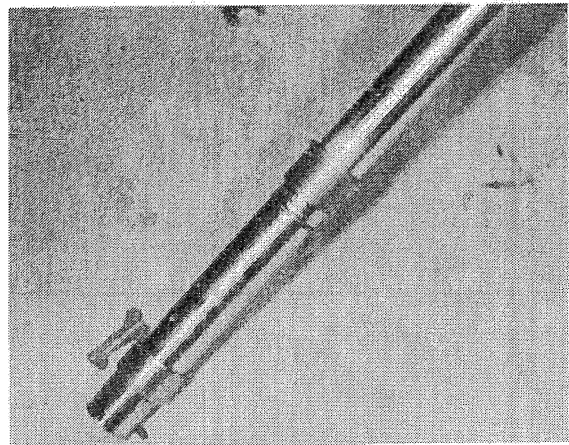

6.1 Arrangement of bushes on stanchion

### 8 Front forks - reassembly

- 1 To reassemble the front forks, follow the dismantling procedure in reverse. Extreme care should be taken when assembling the plated cup and oil seal on the stanchion as the seal is easily damaged. If a small plastic bag is placed over the end of the inner tube this will avoid damage to the seal and facilitate the assembly. It is advisable to smear the sliding members with grease as well as the inside lips of each seal.
- 2 Tighten the steering head carefully, so that all play is eliminated without placing undue stress on the bearings. The adjustment is correct if all play is eliminated and the handlebars will swing to full lock of their own accord when given a push on one end.
- 3 It is possible to place several tons pressure on the steering head bearings if they are overtightened. The usual symptom of overtight bearings is a tendency for the machine to roll at low speeds, even though the handlebars may appear to turn quite freely.
- 4 If, after assembly, it is found that the forks are incorrectly aligned or unduly stiff in action, loosen the front wheel spindle, the two top fork leg nuts and the pinch bolts in the bottom yoke. The forks should then be pumped up and down several times to re-align them. Retighten all the nuts and bolts in the same order, finishing with the steering head pinch bolt.
- 5 This same procedure can be adopted if the forks are misaligned after an accident. Often the legs will twist within the fork yokes giving the impression of more serious damage, even though no structural damage has occurred.
- 6 Do not forget to add 154 cc of Castrolite to the right hand fork leg and 136 cc to the left hand fork leg before replacing the bolts and washers at the top of the fork legs.

### 9 Frame assembly - examination and renovation

- 1 The frame is unlikely to need any special attention unless the machine has been involved in an accident or has covered a very large mileage. Small welding and straightening jobs are possible, but care must be taken to limit the amount of heat used and the area to be heated because the load carrying properties diminish when the metal is heated excessively.
- 2 Frame alignment should be checked when the machine is complete. The accompanying diagram shows how a board placed each side of the rear wheel can be used as a guide to alignment. It is, of course, necessary to ensure that both wheels are centrally disposed within their respective forks before carrying out this check.
- 3 Serious damage is not repairable because the frame is made from steel pressings. The purchase of a new frame is invariably cheaper than the cost of attempting to straighten a damaged frame, especially when the necessary jigs for correct alignment are not available.

### 10. Swinging arm rear suspension - removal from frame

- 1 After an extended period of service the Silentbloc type swinging arm bushes will wear and need replacing. The rear suspension units are of a sealed type and if they do not function properly cannot be repaired but must be renewed as a matched pair.
- 2 Commence operations by placing the machine on the centre stand.
- 3 Remove the rear brake adjuster nut and slide the brake rod out of the brake arm.
- 4 Remove the split pin from the rear brake plate anchor bolt and remove the anchor nut and washer. The anchor arm can now be pulled clear.
- 5 On the left hand side of the machine the small wheel spindle nut is now removed and the wheel spindle pulled out from the

right hand side. The spacer between the wheel and the swinging arm can now be pulled clear.

- 6 The rear wheel can now be pulled clear of the sprocket and if the machine is tilted to one side the wheel can be pulled clear of the machine.
- 7 The pedalling components should now be removed as described in Chapter 1, Section 5, paragraphs 5 to 7.
- 8 The two bolts holding the chainguard and the chainguard itself can now be removed.
- 9 Disconnect the final drive chain at the spring link and pull it clear of the rear sprocket.
- 10 Remove the large wheel spindle nut and adjuster to allow the sprocket to be pulled clear of the machine.
- 11 Undo the acorn nuts at the bottom of the rear suspension units and remove the bolts and washers.
- 12 The nut on the silencer bracket should be removed and the swinging arm pivot rod pulled clear. The swinging arm is now detached from the machine for further work.

### 11 Swinging arm rear suspension - renovation and reassembly

- 1 The Silentbloc type swinging arm bushes can be tapped out of the swinging arm and the new ones tapped in but care should be taken to tap only the outer metal of the bushes or damage to the rubber and its bonding will result. As an alternative, the new bushes can be used to remove the old ones provided that they are pressed in.
- 2 To reassemble the swinging arm, reverse the removal procedure ensuring that the chain and rear brake are properly adjusted.

### 12 Rear suspension units - examination

These are sealed units and cannot be repaired. The units should be checked for any oil leaks and the rubber bushes in each end checked to ensure that they have not perished.

### 13 Centre stand - examination

- 1 The centre stand is attached to a lug on the bottom of the frame, to provide a convenient means of parking the machine on level ground. It pivots on a long bolt which passes through the lug, secured by a nut and washer. A return spring retracts the stand when the machine is pushed forward, so that it can be wheeled prior to riding.
- 2 The condition of the return spring and the return action should be checked regularly, also the security of the retaining nut and bolt. If the stand stops whilst the machine is in motion it could catch in some obstacle in the road and unseat the rider.

### 14 Speedometer - removal and replacement

- 1 A speedometer of the magnetic type is fitted to a support bar above the headlight. It contains also the odometer for recording the total mileage covered by the machine.
- 2 The speedometer is retained by two clips. To remove the speedometer, detach the drive cable, disconnect the electrical wiring and remove the two clips under the mounting bracket ensuring that the D-shaped washers are not lost. The speedometer can now be removed with its rubber cup.
- 3 Although a speedometer on a machine of less than 100 cc capacity is not a statutory requirement in the UK, if one is fitted it must be in good working order. Reference to the mileage reading shown on the odometer is a good way of keeping in pace with the routine maintenance schedule.
- 4 Apart from defects in either the speedometer drive or in the drive cable itself, a speedometer which malfunctions is difficult to repair. Fit a replacement or alternatively, entrust the repair to an instrument repair specialist.

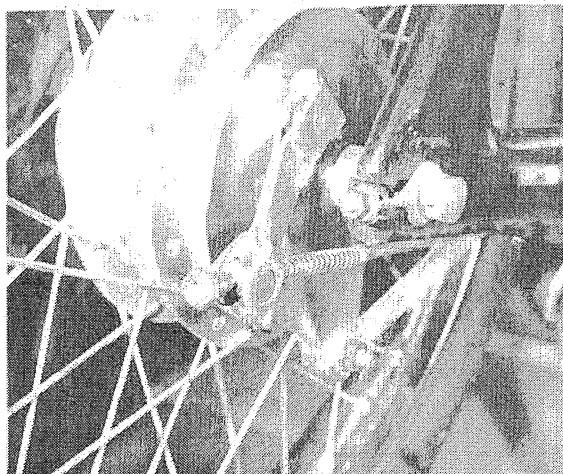

10.3 Remove adjuster nut from rear brake rod



10.4 Disconnect anchor arm from rear brake plate

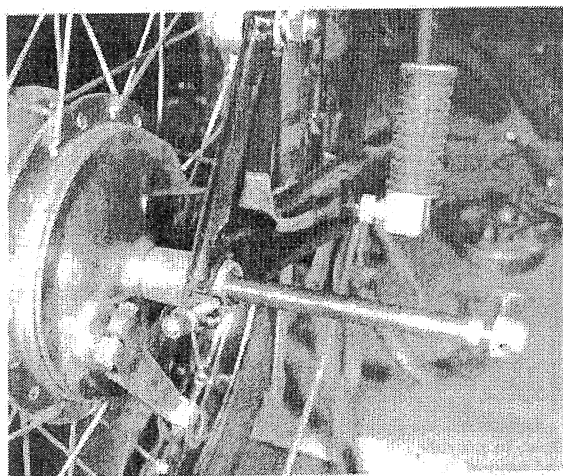

10.6a Pull out spindle after removing nut on left-hand end and ...

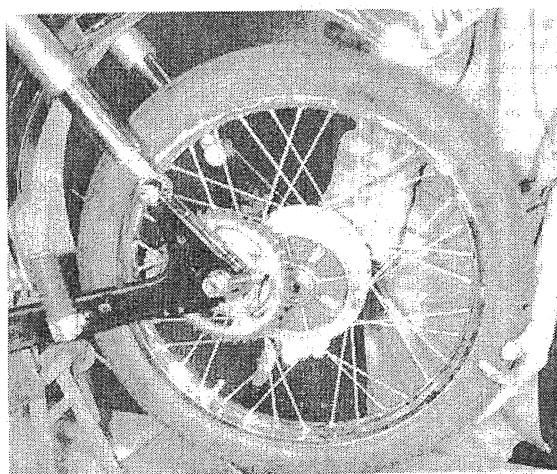

10.6b ... tilt machine slightly to give clearance for wheel removal

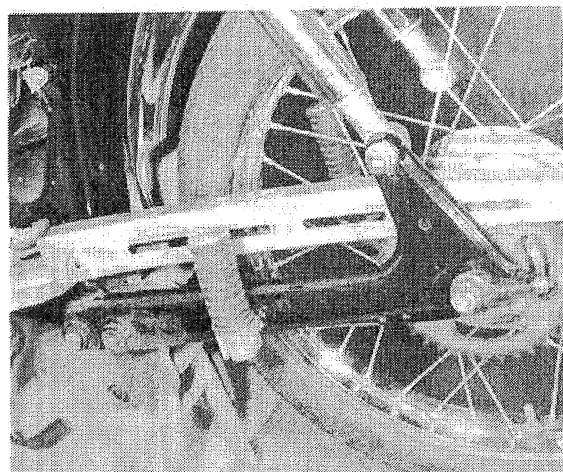

10.8 Remove final drive chain guard

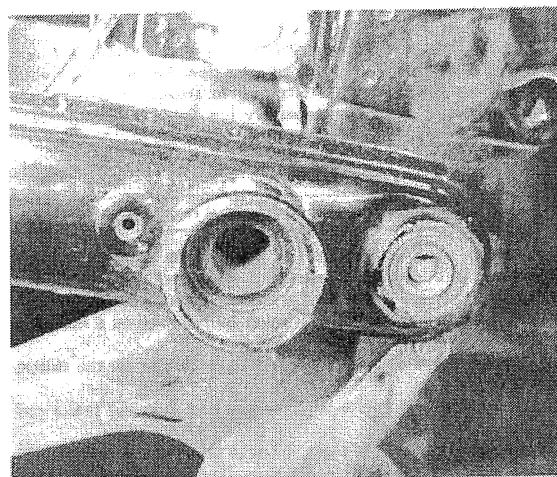

10.12 After nut on silencer bracket is removed, pivot rod will pull out from left

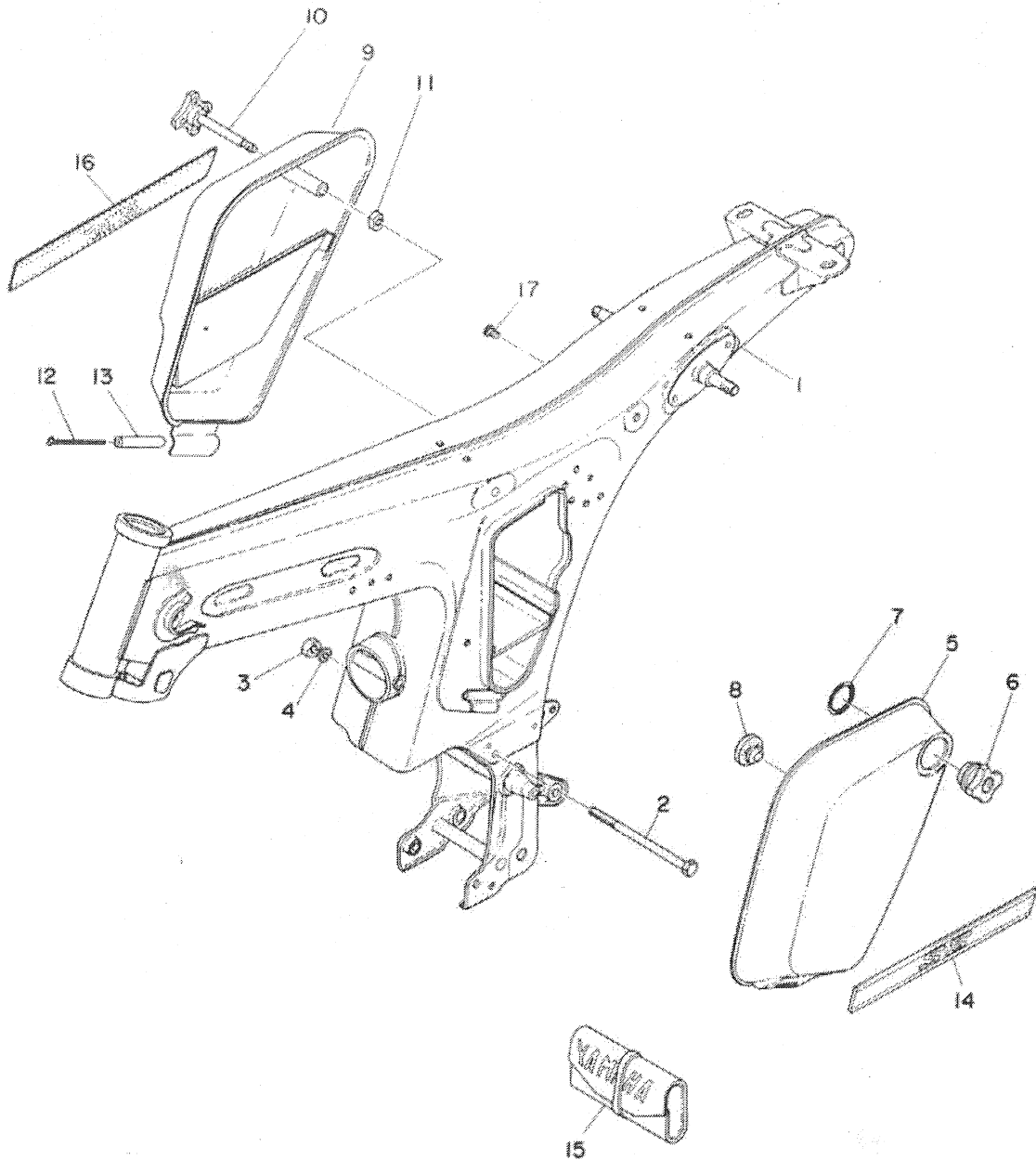

Fig. 4.3. Frame assembly

- |                        |                            |                              |                        |
|------------------------|----------------------------|------------------------------|------------------------|
| 1 Frame complete       | 6 Knob for left-hand cover | 10 Knob for right-hand cover | 14 Side cover transfer |
| 2 Bolt                 | 7 Limiting ring            | 11 Nut for latch clamp       | 15 Tool roll           |
| 3 Nut                  | 8 Rubber for side cover    | 12 Split pin                 | 16 Side cover transfer |
| 4 Spring washer        | 9 Right-hand side cover    | 13 Bush                      | 17 Blind plug          |
| 5 Left-hand side cover |                            |                              |                        |

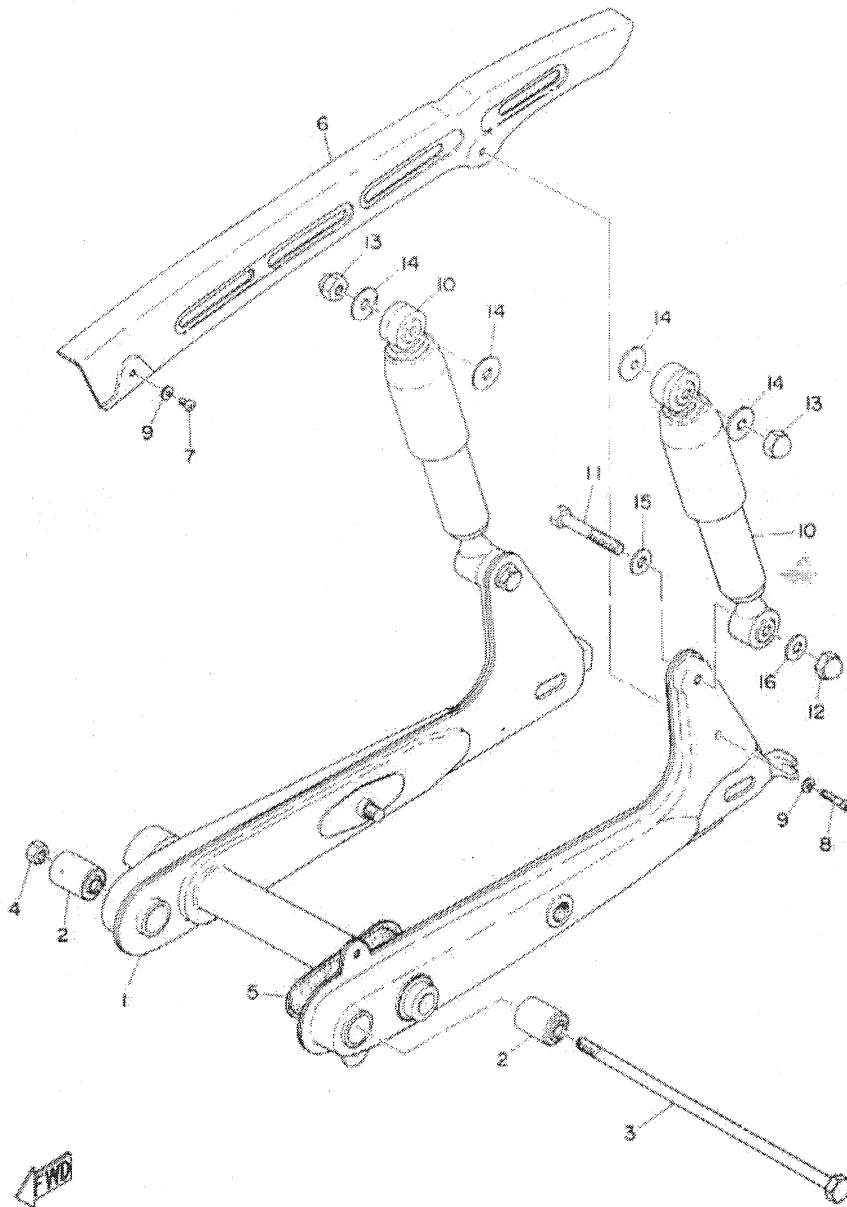

Fig. 4.4. Swinging arm fork and suspension units

- |  |  |   |                         |
|--|--|---|-------------------------|
| 1 Swinging arm fork complete                     | 4 Nut for pivot                        | 8. Panhead screw for chainguard (rear)            | 12 Acorn nut - 2 off    |
| 2 Silentbloc bush for swinging arm pivot - 2 off | 5 Guard seal                           | 9 Spring washer - 2 off                           | 13 Acorn nut - 2 off    |
| 3 Pivot for swinging arm fork                    | 6 Chainguard                           | 10 Rear suspension unit - 2 off                   | 14 Washer - 4 off       |
|  | 7 Panhead screw for chainguard (front) | 11 Bolt for rear-suspension unit mounting - 2 off | 15 Plain washer - 2 off |
|  |  |   | 16 Plain washer - 2 off |

### 15 Speedometer cable - inspection and maintenance

- 1 It is advisable to detach the speedometer drive cable from time to time, in order to check whether it is adequately lubricated and whether the outer covering is compressed or damaged at any point along its run. A jerky or sluggish speedometer movement can often be attributed to a cable fault.
- 2 To grease the cable, detach the drive from the speedometer head and withdraw the inner cable. After removing the old grease, clean the cable with a petrol soaked rag and examine the cable for broken strands or other damage.
- 3 Regrease the cable with high melting point grease, taking care not to grease the last six inches at the end where the cable enters the speedometer head. If this precaution is not observed, grease will work into the speedometer head and immobilise the movement.
- 4 If the speedometer and the odometer stop working, it is probable that the inner cable has broken. Inspection will show the cause of the trouble; if the inner cable has broken it can be renewed on its own and reinserted in the outer covering, after greasing. Never fit a new inner cable alone if the outer covering is damaged also or is compressed at any point along its run.

### 16 Dualseat - removal

The dualseat is used to hold the petrol tank on the machine and is fixed with four bolts. After the removal of these bolts, the

dualseat simply lifts off the machine.

### 17 Steering head lock

All models are fitted with a steering head lock. When the lock is actuated, a tongue protrudes through a hole in an extension of the steering head base, to secure the handlebars on full lock. No attention is necessary other than the occasional application of light oil. If the lock malfunctions, it must be replaced.

### 18 Cleaning - general

- 1 After removing all surface dirt with a rag or sponge which is washed frequently in clean water, the application of car polish or wax will give a good finish to the cycle parts of the machine. The plated parts should require only a wipe over with a damp rag, unless salt has caused heavy corrosion. Under these circumstances one of the proprietary chromium plating cleaners can be used.
- 2 If possible, the machine should be wiped over immediately after it has been used in the wet, so that it is not garaged in damp conditions which will promote rusting. Make sure the chain is wiped and if necessary re-oil it, to prevent water from entering the rollers and causing harshness with an accompanying greater rate of wear. Remember there is less chance of water entering the control cables if they are lubricated regularly, as recommended in the Routine Maintenance Section.

### 19 Fault diagnosis - frame and forks

| Symptom  | Reason/s  | Remedy   |
|--|---|--|
| Machine is unduly sensitive to road surface irregularities | Fork and/or rear suspension units damping ineffective                     | Check oil level in forks.<br>Renew suspension units as a pair.   |
| Machine rolls at low speeds                                | Steering head bearings overtight or damaged                               | Slacken bearing adjustment. If no improvement, dismantle and inspect head bearings.  |
| Machine tends to wander; steering is imprecise             | Worn swinging arm suspension bearings                                     | Check and if necessary renew pivot spindle and bush.   |
| Fork action stiff  | Fork legs have twisted in yokes or have been drawn together at lower ends | Slacken off spindle nut, pinch bolts in yoke and fork top nuts. Pump forks several times before re-tightening from bottom. |
| Forks judder when front brake is applied                   | Worn fork bushes<br>Steering head bearings too slack                      | Strip forks and renew worn bushes.<br>Re-adjust to take up play.   |
| Wheels seem out of alignment                               | Frame distorted as result of accident damage                              | Check frame. If bent, specialist repair is necessary.  |



# Chapter 5 Wheels, brakes and tyres

## Contents

|  |   |
|--|---|
| General description ... .. 1                                   | Rear wheel bearings - inspection and replacement ... .. 11        |
| Front wheel - inspection and renovation ... .. 2               | Rear wheel sprocket - removal, examination and replacement ... 12 |
| Front wheel - removal ... .. 3                                 | Rear wheel - completion of reassembly and replacement ... 13      |
| Front brake assembly - inspection, renovation and reassembly 4 | Pedal assembly - examination and replacement ... .. 14            |
| Front wheel bearings - inspection and replacement ... .. 5     | Front and rear brakes - adjustment ... .. 15                      |
| Speedometer drive gearbox - examination & replacement ... 6    | Final drive chain - inspection and lubrication ... .. 16          |
| Front wheel - replacement ... .. 7                             | Peddalling gear chain - inspection and lubrication ... .. 17      |
| Rear wheel - inspection and renovation ... .. 8                | Tyres - removal and replacement ... .. 18                         |
| Rear wheel - removal ... .. 9                                  | Fault diagnosis - wheels, brakes and tyres ... .. 19              |
| Rear brake assembly - inspection, renovation and reassembly 10 |   |

## Specifications

|                               |  |
|-------------------------------|--|
| <b>Wheels:</b>                |  |
| Size ... ..                   | 17 in. diameter, front and rear. Not interchangeable |
| <b>Tyres:</b>                 |  |
| Size ... ..                   | 17 in. x 2.25 in. front                              |
|                               | 17 in. x 2.50 in. rear                               |
| <b>Tyre pressures:</b>        |  |
| Front ... ..                  | 20 p.s.i. (1.4 kg/cm <sup>2</sup> )                  |
| Rear ... ..                   | 28 p.s.i. (1.9 - 2.0 kg/cm <sup>2</sup> )            |
| <b>Brakes:</b>                |  |
| Diameter of brake drum ... .. | 4.33 in. (110 mm) front and rear                     |

### 1 General description

The wheels are 17 inch diameter with a larger section tyre on the rear being 2.50 inch as opposed to 2.25 inch on the front. Each hub contains a 110 mm internally expanding brake which gives excellent braking. Both wheels are of the quickly-detachable type but are not interchangeable as the rear hub contains the rubber transmission shock absorber.

### 2 Front wheel - inspection and renovation

1 Place the machine on the centre stand so that the front wheel is raised clear of the ground. Spin the wheel and check for rim alignment or run-out. Small irregularities can be corrected by tightening the spokes in the area affected, although a certain amount of experience is advisable if over-correction is to be avoided.

2 Any flats in the wheel rim should be evident at the same time. These are much more difficult to remove and in most cases the wheel will need to be rebuilt on a new rim. Apart from the

effect on stability, there is greater risk of damage to the tyre bead and walls if the machine is run with a deformed wheel. In an extreme case the tyre can even separate from the rim.

3 Check for loose or broken spokes. Tapping the spokes is the best guide to tension. A loose spoke will produce a quite different sound and should be tightened by turning the nipple in an anticlockwise direction. Always recheck for run-out by spinning the wheel again.

4 If it is necessary to turn a spoke nipple an excessive amount to restore tension, it is advisable to remove the tyre and tube so that the end of the spoke that now protrudes into the wheel rim can be ground flush. If this precaution is not taken, there is danger of the spoke end chafing the inner tube and causing an eventual puncture.

### 3 Front wheel - removal

1 Commence operations by placing the machine on the centre stand.

- 2 Slacken the front brake cable and disconnect it from the brake.
- 3 Remove the circlip retaining the speedometer cable in the brake plate and pull the cable clear.
- 4 Undo the front wheel spindle nut and withdraw the wheel spindle. Support the machine to stop it from toppling forward.
- 5 The front wheel will now drop clear of the machine. Remove the spacer on the left hand side of the wheel to avoid it being lost.

#### 4 Front brake assembly - inspection, renovation and reassembly

- 1 To remove the brake assembly, lift it out from the brake drum.
- 2 Examine the brake linings. If they are wearing thin or unevenly, the brake shoes should be replaced. The linings are bonded on and cannot be replaced as a separate item.
- 3 To remove the brake shoes from the brake plate assembly, arrange the operating lever so that the brakes are in the 'full on' position and then pull the shoes apart whilst lifting them upward in the form of a 'V'. When they are clear of the brake plate, the return springs can be removed and the shoes separated.
- 4 Before replacing the brake shoes, check that the brake operating cam is working smoothly and is not binding in its pivot. The cam can be removed by withdrawing the retaining nut on the operating arm and pulling the arm off the shaft. Before removing the arm, it is advisable to mark its position in relation to the shaft, so that it can be relocated correctly. The shaft should be greased prior to reassembly and also a light smear of grease placed on the faces of the operating cam.
- 5 Check the inner surface of the brake drum on which the brake shoes bear. The surface should be smooth and free from score marks or indentations, otherwise reduced braking efficiency will be inevitable. Remove all traces of brake lining dust and wipe with a clean rag soaked in petrol to remove any traces of grease or oil.
- 6 If the brake drum has become scored, specialist attention is required. It is possible to skim a brake drum in a lathe provided the score marks are not too deep. Under these circumstances, packing will have to be added to the ends of the brake shoes, to compensate for the amount of metal removed from the surface of the drum.
- 7 To reassemble the brake shoes on the brake plate, fit the return springs first and then force the shoes apart, holding them in a 'V' formation. If they are now located with the brake operating arm and pivot they can usually be snapped into

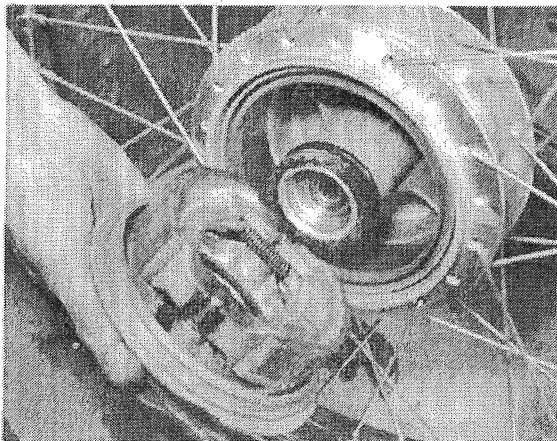

4.1 The front brake assembly will lift from brake plate

position by pressing downward. Never use excessive force, otherwise there is risk of distorting the shoes permanently.

#### 5 Front wheel bearings - inspection and replacement

- 1 The front wheel bearings are of the ball journal type and are not adjustable. If the bearings are worn, indicated by side play on the wheel rim, the bearings must be renewed.
- 2 Access to the wheel bearings is gained when the brake assembly has been removed from the front wheel.
- 3 To remove the first bearing drive the bearing spacer out from the brake hub side using a suitable drift. This will push out the bearing and the oil seal. The second bearing can then be driven out from the other side of the wheel.
- 4 To reassemble the bearings, drive one side in first, fit the bearing spacer and drive the second bearing in. Refit the oil seal taking care not to damage it.

#### 6 Speedometer drive gears - examination and replacement

- 1 The drive gears should be checked for wear or broken teeth and renewed if necessary.
- 2 To renew the large drive gear on the hub, it may be necessary to heat the drive ring before driving the hub out from the inside. The oil seal behind the gear should also be renewed as it will have been damaged. The new drive gear may also need heating before fitting as the gear is a very tight fit on the hub. Extreme caution should be used to avoid damage to the new oil seal.
- 3 To renew the small worm gear in the brake plate it is necessary to prise out the small oil seal, unscrew the bush and withdraw the worm gear. Reassemble in reverse, using the above procedure.
- 4 Thoroughly grease the gears before refitting the brake plate.

#### 7 Front wheel - replacement

- 1 To replace the front wheel, reverse the removal procedure and ensure that the peg on the forks locates in the slot in the brake plate.
- 2 Reconnect the front brake and check that the brake functions correctly, especially if the adjustment has been altered or the brake operating arm has been removed and replaced during the dismantling operation.

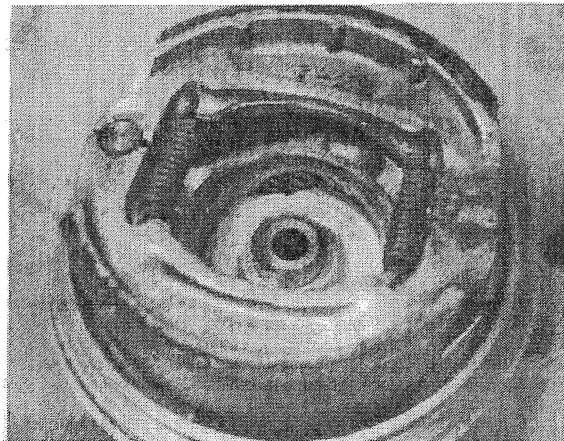

4.2 Examine brake linings for wear or damage

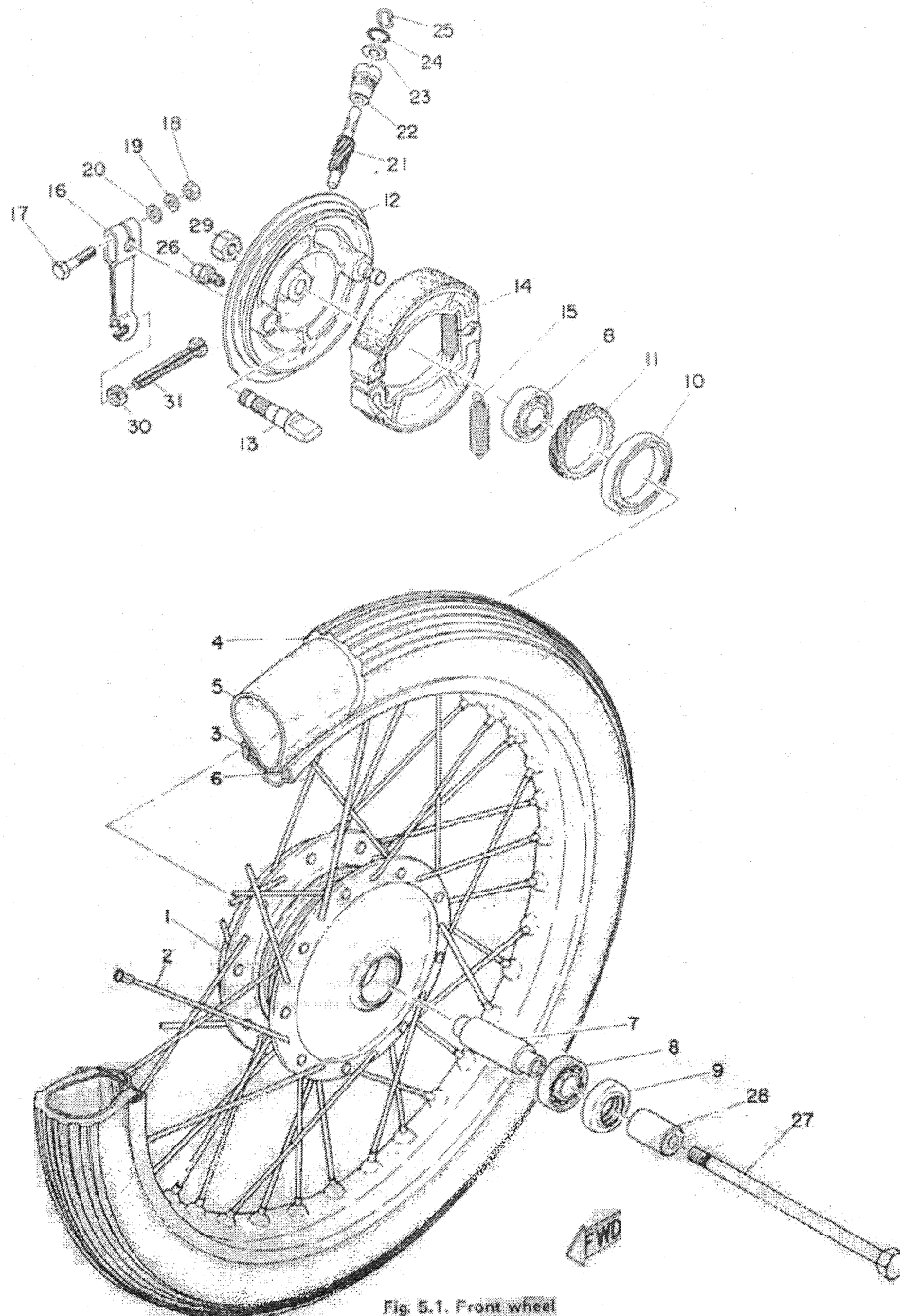

Fig 5.1. Front wheel

- |                              |   |                                  |                          |
|------------------------------|---|----------------------------------|--------------------------|
| 1. Hub                       | 7. Wheel bearing spacer                     | 15. Brake shoe return spring     | 22. Bush                 |
| 2. Spoke set                 | 8. Wheel bearings - 2 off                   | 16. Brake operating arm          | 23. Oil seal             |
| 3. Rim (17 inch diameter)    | 9. Left hand oil seal                       | 17. Bolt for brake operating arm | 24. O ring               |
| 4. Front tyre 2.25 x 17 inch | 10. Right hand oil seal                     | 18. Nut                          | 25. Stop ring (clip)     |
| 5. Inner tube 2.25 x 17 inch | 11. Speedometer drive pinion                | 19. Spring washer                | 26. Grease nipple        |
| 6. Rim tape                  | 12. Brake plate                             | 20. Plain washer                 | 27. Front wheel spindle  |
|                              | 13. Brake operating cam                     | 21. Speedometer driven pinion    | 28. Spacer               |
|                              | 14. Brake shoe complete with lining - 2 off |                                  | 29. Wheel spindle nut    |
|                              |   |                                  | 30. Brake cable adjuster |
|                              |   |                                  | 31. Adjuster locknut     |

**8 Rear wheel - inspection and renovation**

- 1 Place the machine on the centre stand so that the rear wheel is clear of the ground. Check the wheel for rim alignment, damage to the rim or loose or broken spokes, by following the procedure adopted for the front wheel in the preceding Section.
- 2 Note that although the front and rear wheels are of identical size and have hubs of similar diameter, they cannot be interchanged.

**9 Rear wheel - removal**

- 1 Commence operations by placing the machine on the centre stand.
- 2 Remove the rear brake adjuster nut and slide the brake rod out of the brake arm.

- 3 Remove the split pin from the brake plate anchor bolt and remove the anchor nut and washer. The anchor arm can now be pulled clear.

- 4 On the left hand side of the machine the small wheel spindle nut is now removed and the wheel spindle pulled out from the right hand side. The spacer between the wheel and the swinging arm can now be pulled clear.

- 5 The rear wheel can now be pulled clear of the sprocket and if the machine is tilted to one side the wheel can be pulled clear of the machine.

**10 Rear brake assembly - inspection, renovation and reassembly**

The rear brake assembly is removed and dismantled by following the procedure adopted for the front brake assembly, as detailed in Section 4 of this Chapter.

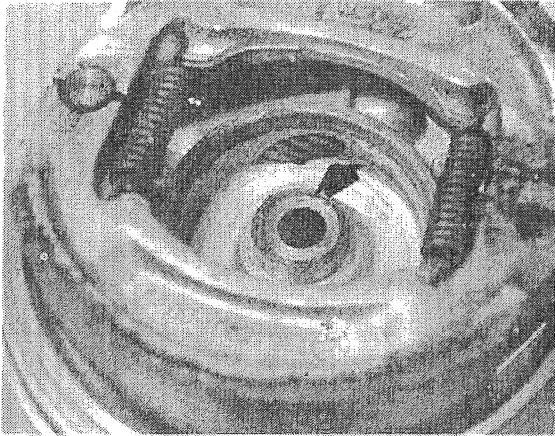

6.1 Check speedometer drive pinions for wear

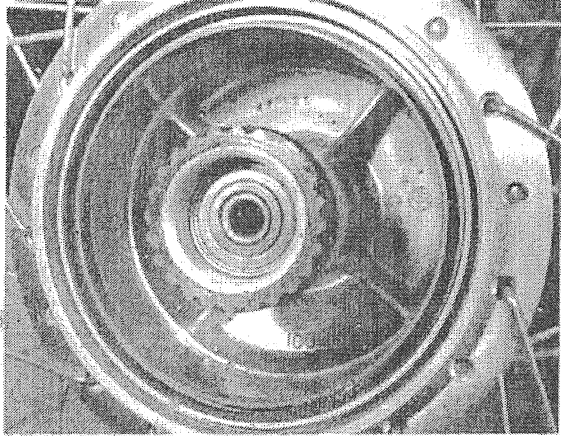

6.2 Large drive pinion is shrink fit on hub

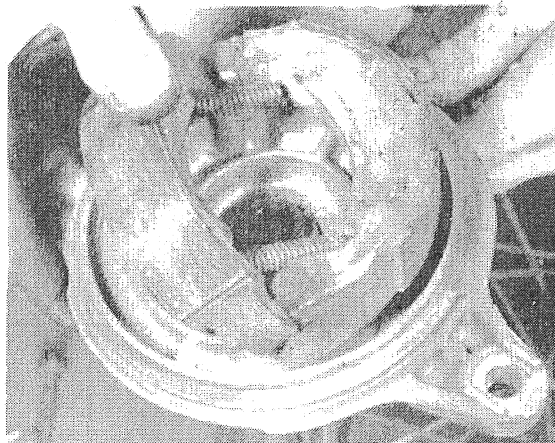

10.1 Ease brake shoes upwards whilst holding them apart

### 11 Rear wheel bearings - inspection and replacement

- 1 The rear wheel bearings are of the ball journal type and are not adjustable. If the bearings are worn, indicated by side play on the wheel rim, the bearings must be renewed.
- 2 To remove the first bearing drive the bearing spacer out from the sprocket side using a suitable drift. This will push out the bearing and the oil seal. The second bearing can then be driven out from the other side of the wheel.
- 3 To reassemble the bearings, drive one side in first, fit the bearing spacer and drive the second bearing in. Refit the oil seal taking care not to damage it.
- 4 It is advisable to replace the O ring on the sprocket side of the hub to ensure that no grease can reach the shock absorber rubbers.

### 12 Rear wheel sprocket and shock absorber assembly - removal, examination and replacement

- 1 The rear wheel sprocket assembly is removed as follows:

Disconnect the chain at the spring link and pull it clear of the rear sprocket. Remove the large wheel spindle nut and adjust to allow the sprocket assembly to be pulled clear of the machine (It is assumed that the rear wheel has already been removed.)

2 The sprocket assembly has a ball journal bearing and if worn the following procedure should be followed:

3 Remove the stub axle and spacer from the assembly. Press out the oil seal. Remove the retaining circlip and drive out the bearing.

4 To replace the bearing, reverse the procedure using a new seal as the old one will be damaged when it is removed.

5 It is unlikely that the sprocket will require renewal until very substantial mileage has been covered. The usual signs of wear occur when the teeth assume a hooked or very shallow formation which will cause rapid wear of the chain. A worn sprocket must be replaced, together with the gearbox final drive sprocket and the chain. Always replace the final drive assembly as a complete set, otherwise rapid wear will occur as the result of running old and new parts together.

6 To replace the sprocket, prise down the tab washers or remove the four retaining bolts. Reassemble in the reverse order.



11.2a Oil seal is in front of wheel bearings, will be displaced before ...

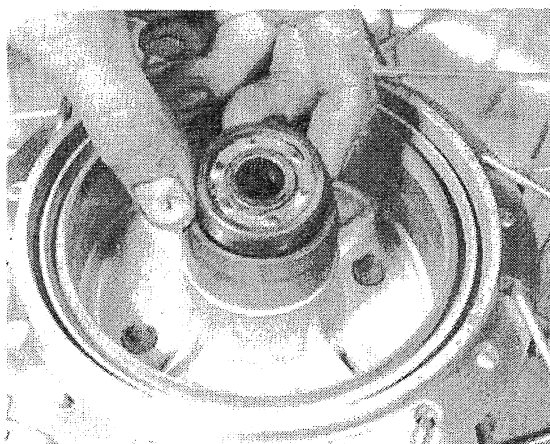

11.2b ... bearing itself emerges from hub

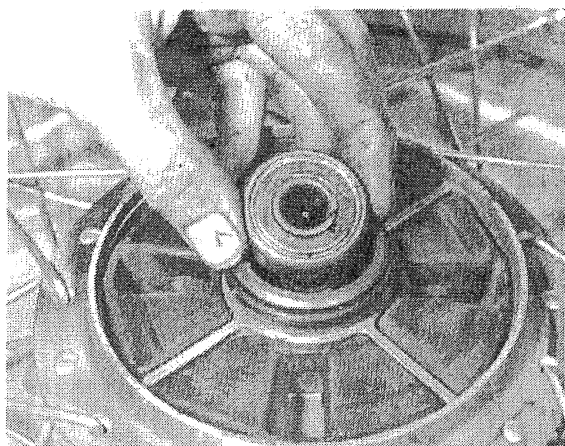

11.2c Remaining bearing will drive out from opposite direction

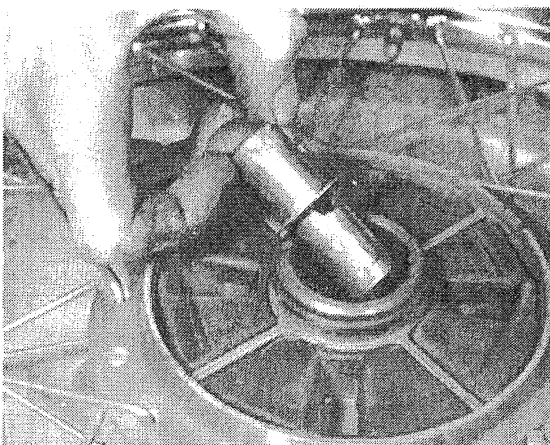

11.3 When refitting, do not omit bearing spacer

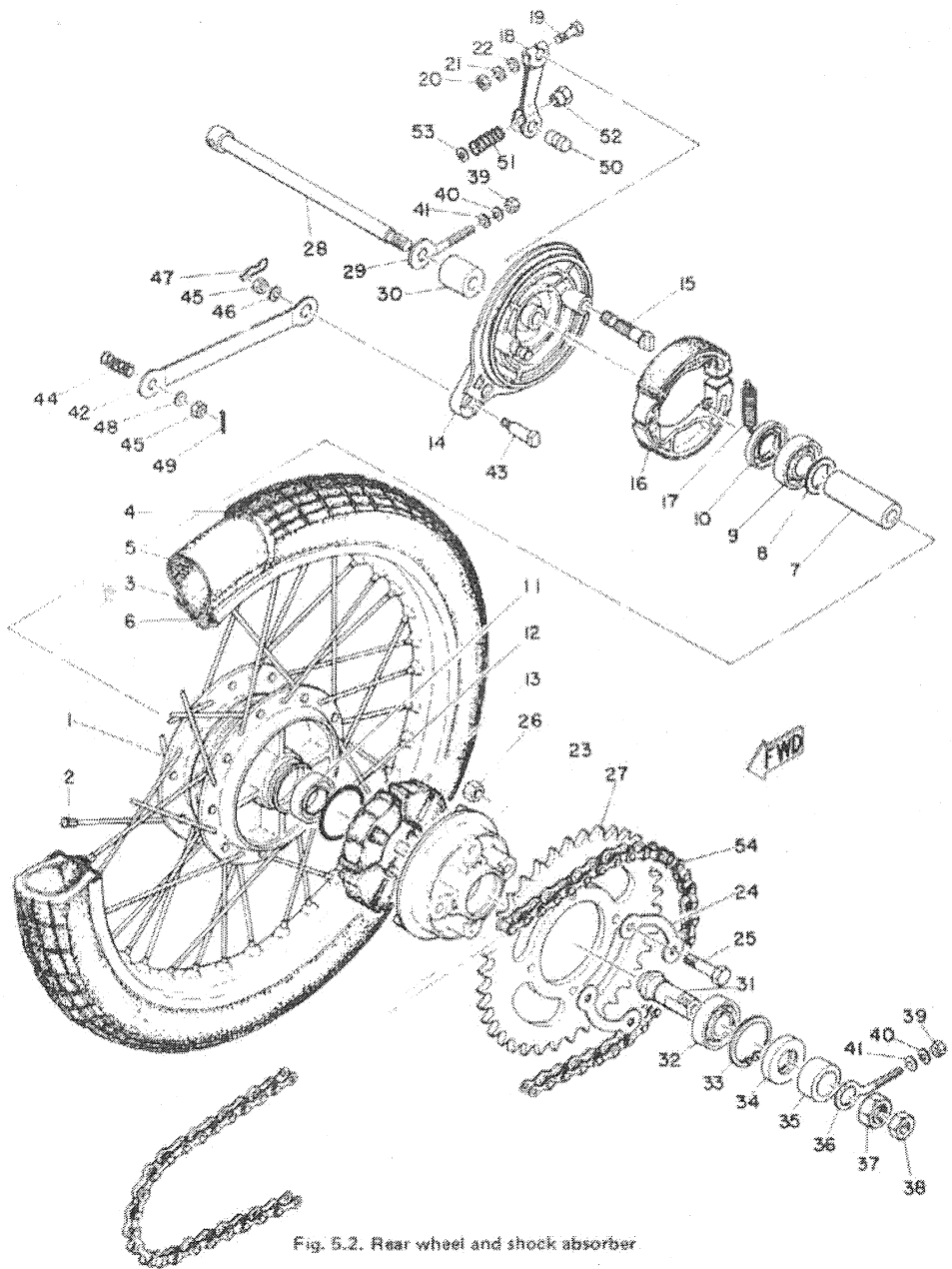

Fig. 5.2. Rear wheel and shock absorber

- |                                   |  |                                   |                                   |
|-----------------------------------|--|-----------------------------------|-----------------------------------|
| 1 Hub                             | 16 Brake shoe complete with lining - 2 off | 27 Rear wheel sprocket (39 teeth) | 41 Plain washer - 2 off           |
| 2 Spoke set                       | 17 Brake shoe return spring - 2 off        | 28 Rear wheel spindle             | 42 Rear brake anchor arm          |
| 3 Rim (17 inch diameter)          | 18 Brake operating arm                     | 29 Right-hand chain adjuster      | 43 Anchor arm bolt                |
| 4 Rear tyre 2.50 x 17 inch        | 19 Bolt for brake operating arm            | 30 Wheel spacer                   | 44 Anchor arm spring              |
| 5 Inner tube 2.50 x 17 inch       | 20 Nut                                     | 31 Stub axle                      | 45 Nut - 2 off                    |
| 6 Rim tape                        | 21 Spring washer                           | 32 Stub axle bearing              | 46 Spring washer                  |
| 7 Wheel bearing spacer            | 22 Plain washer                            | 33 Circlip                        | 47 Clip for anchor arm bolt       |
| 8 Spacer frange                   | 23 Shock absorber hub (cush drive)         | 34 Oil seal                       | 48 Plain washer                   |
| 9 Right-hand wheel bearing        | 24 Lock washer for sprocket bolts - 2 off  | 35 Distance piece                 | 49 Split pin                      |
| 10 Right-hand oil seal            | 25 Sprocket bolt - 4 off                   | 36 Stub axle nut                  | 50 Trunnion                       |
| 11 Left-hand wheel bearing        | 26 Nut - 4 off                             | 37 Wheel spindle nut              | 51 Spring for brake operating rod |
| 12 'O' ring                       |  | 38 Chain adjuster nut - 2 off     | 52 Brake adjusting nut            |
| 13 Shock absorber rubbers - 4 off |  | 39 Spring washer - 2 off          | 53 Plain washer                   |
| 14 Rear brake plate               |  | 40 Final drive chain (96 links)   |                                   |
| 15 Brake operating cam            |  |                                   |                                   |

7 The shock absorber rubbers will remain in the wheel hub and should be checked for any damage or deterioration. All oil or grease should be wiped away as this may cause premature deterioration.

### 13 Rear wheel - reassembly

- 1 To refit the rear wheel reverse the removal procedure.
- 2 Before fully tightening all the nuts ensure that the final chain tension and the brake adjustment are correct.
- 3 Check also whether the wheel alignment is correct. The rear chainstays are marked with indentations so that a visual check can be made.

### 14 Pedal assembly - examination and replacement

- 1 As pedals are fitted to this machine to make it legal for 16 year olds to ride, there should be very little wear and parts should only need replacing due to accidental damage.
- 2 The pedals are normal bicycle pedals which are unscrewed and new ones screwed in if necessary. Note that the right hand pedal has a left hand thread.
- 3 If the left hand crank and chainwheel need renewing, the procedure is found in Chapter 1, Section 5, paragraphs 5 to 7.
- 4 If the right hand crank needs renewing the rubber boot should be pulled up the crank to expose a circlip on the shaft, which retains the crank. There is a slot in the crank into which the peg in the shaft must go to allow the crank to slide off.
- 5 To replace the spring it is easiest to remove the shaft from the machine prior to detaching the small circlip and spring.
- 6 If either crank is bent, renewal is advised. They are difficult to straighten without risk of a fracture occurring.

### 15 Front and rear brakes - adjustment

- 1 The front brake adjuster is located on the front brake plate. The brake should be adjusted so that the wheel is free to revolve before pressure is applied to the handlebar lever and is applied fully before the handlebar lever touches the handlebar. Make sure that the adjuster locknut is tight after the correct adjustment has been made.

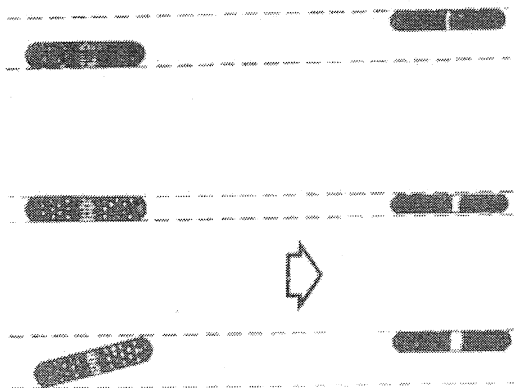
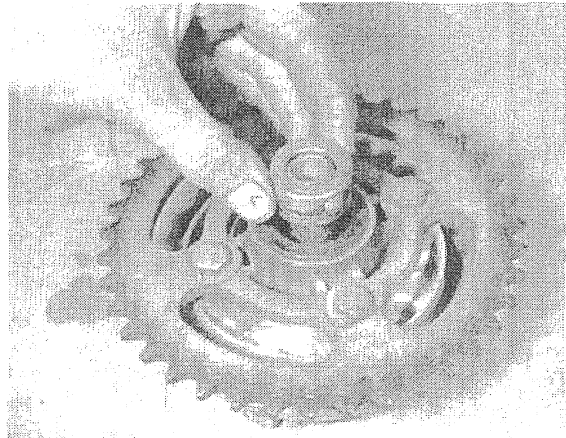
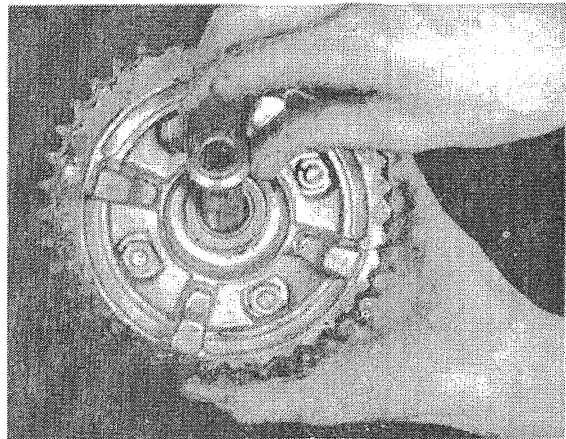

Fig. 5.3. Checking wheel alignment



12.1a Rear wheel sprocket bolts to shock absorber plate ...



12.1b ... contains stub axle and own bearing

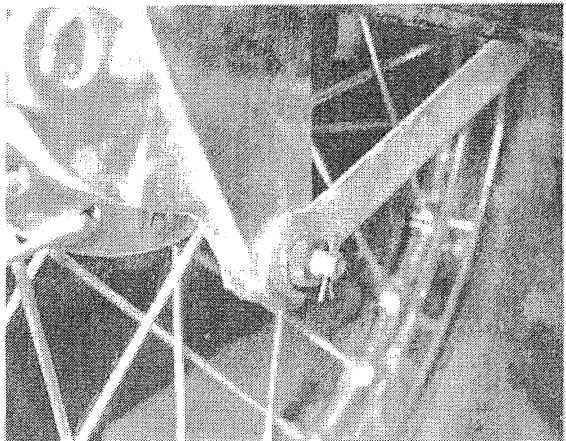

12.2 Don't omit spring clip after final tightening

2 The rear brake is adjusted by means of the adjusting nut on the end of the brake operating rod. This nut is self-locking. Adjustment is largely a matter of personal choice, but excessive travel of the footbrake pedal should not be necessary before the brake is applied fully.

3 Check frequently that the rear brake torque arm bolt is tight. If the torque arm becomes detached, the rear brake will lock in the full-on position immediately it is applied and may give rise to a serious accident.

4 Efficient brakes depend on good leverage of the operating arms. The angle between the brake operating arm and the cable or rod should never exceed 90° when the brake is fully applied.

#### 16 Final drive chain - inspection and lubrication

1 Periodically, the tension of the final drive chain should be checked by measuring the amount of play in the middle of the bottom run. The chain is in correct adjustment if there is from 5/8 to 7/8 inch play.

2 To adjust the chain, slacken the rear wheel nuts and draw the rear wheel spindle either forward or backward until the correct tension is achieved, by means of the chain adjusters. Tighten the wheel nuts and check again that the chain tension is correct.

3 Always adjust the draw bolts an identical amount, otherwise the rear wheel will be thrown out of alignment. If in doubt about the correctness of wheel alignment, use the technique described in Chapter 4, Section 9, paragraph 2.

4 After a period of running, the chain will require lubrication. Lack of oil will accelerate the rate of wear of both chain and sprockets, leading to harsh transmission. The application of an engine oil from an oil can still serves as a satisfactory lubricant, but it is preferable to remove the chain at regular intervals and immerse it in a molten lubricant such as Linklyfe; after it has been cleaned in a paraffin bath. This latter type of lubricant achieves better penetration of the chain links and rollers and is less likely to be thrown off when the chain is in motion.

5 To check whether the chain is due for replacement, lay it lengthwise in a straight line and compress it so that all play is taken up. Anchor one end and then pull on the other end to take up the play in the opposite direction. If the chain extends by more than the distance between two adjacent rollers, it should be replaced in conjunction with the sprockets. Note that this check should be made after the chain has been washed, but before the lubricant has been applied, otherwise the lubricant may take up some of the play.

6 When replacing the chain, make sure the spring link is positioned correctly, with the closed end facing the direction of travel. Reconnection is made easier if the ends of the chain are pressed into the teeth of the rear wheel sprocket.

#### 17 Pedalling gear chain - inspection and lubrication

1 The same advice given in the preceding Section applies to the pedalling gear chain, although this chain is only in occasional use and will not be subjected to anything like the same amount of wear.

2 The pedalling gear chain does not require checking for tension because it is not adjustable. If it is badly worn, it must be renewed.

#### 18 Tyres - removal and replacement

1 At some time or other the need will arise to remove and replace the tyres, either as the result of a puncture or because a replacement is required to offset wear. To the inexperienced, tyre changing represents a formidable task yet if a few simple rules are observed and the technique learned, the whole operation is surprisingly simple.

2 To remove the tyre from either wheel, first detach the wheel from the machine by following the procedure in Chapters 5.3 or

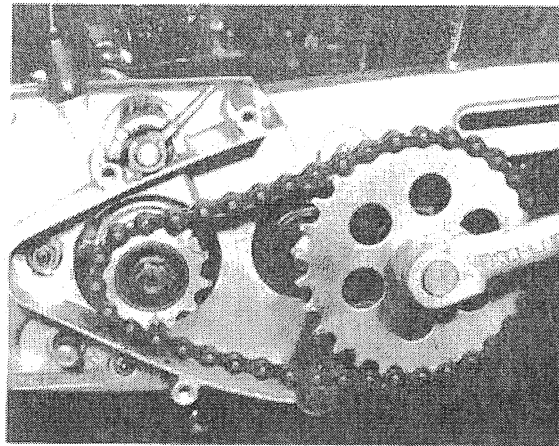

17.2 Pedalling chain has no means of adjustment

5.9 depending on whether the front or the rear wheel is involved. Deflate the tyre by removing the valve insert and when it is fully deflated, push the bead of the tyre away from the wheel rim on both sides so that the bead enters the centre well of the rim. Remove the locking cup and push the tyre valve into the tyre itself.

3 Insert a tyre lever close to the valve and lever the edge of the tyre over the outside of the wheel rim. Very little force should be necessary; if resistance is encountered it is probably due to the fact that the tyre beads have not entered the well of the wheel rim all the way round the tyre.

4 Once the tyre has been edged over the wheel rim, it is easy to work around the wheel rim so that the tyre is completely free on one side. At this stage, the inner tube can be removed.

5 Working from the other side of the wheel, ease the other edge of the tyre over the outside of the wheel rim that is furthest away. Continue to work around the rim until the tyre is free completely from the rim.

6 If a puncture has necessitated the removal of the tyre, re-inflate the inner tube and immerse it in a bowl of water to trace the source of the leak. Mark its position and deflate the tube. Dry the tube and clean the area around the puncture with a petrol soaked rag. When the surface has dried, apply the rubber solution and allow this to dry before removing the backing from the patch and applying the patch to the surface.

7 It is best to use a patch of the self vulcanising type, which will form a very permanent repair. Note that it may be necessary to remove a protective covering from the top surface of the patch, after it has sealed in position. Inner tubes made from synthetic rubber may require a special type of patch and adhesive, if a satisfactory bond is to be achieved.

8 Before replacing the tyre, check the inside to make sure the agent that caused the puncture is not trapped. Check also the outside of the tyre, particularly the tread area, to make sure nothing is trapped that may cause a further puncture.

9 If the inner tube has been patched on a number of past occasions, or if there is a tear or large hole, it is preferable to discard it and fit a replacement. Sudden deflation may cause an accident, particularly if it occurs with the front wheel.

10 To replace the tyre, inflate the inner tube sufficiently for it to assume a circular shape but only just. Then push it into the tyre so that it is enclosed completely. Lay the tyre on the wheel at an angle and insert the valve captive in its correct location.

11 Starting at the point furthest from the valve, push the tyre bead over the edge of the wheel rim until it is located in the central well. Continue to work around the tyre in this fashion until the whole of one side of the tyre is on the rim. It may be necessary to use a tyre lever during the final stages.

12 Make sure there is no pull on the tyre valve and again



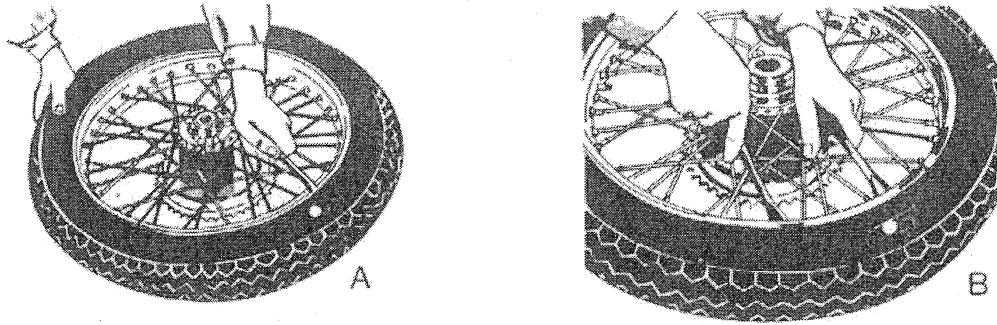

Fig. 5.4a. Tyre removal

- A Deflate inner tube and insert lever in close proximity to tyre valve  
 B Use two levers to work bead over the edge of rim  
 C When first bead is clear, remove tyre as shown

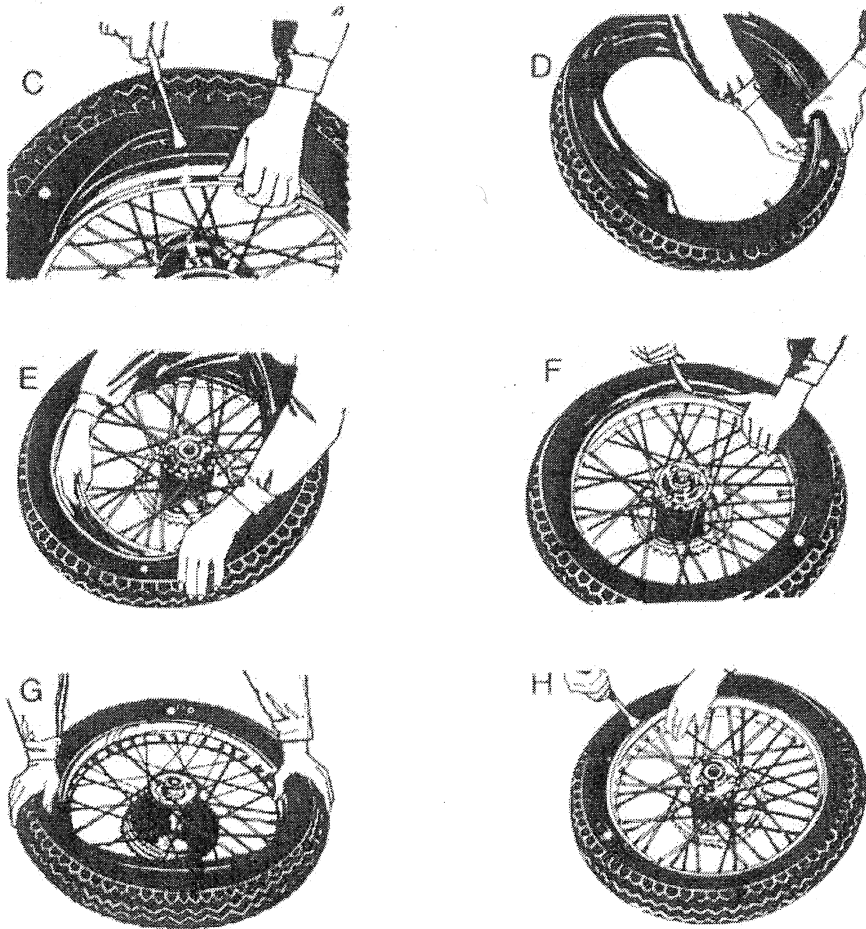

Fig. 5.4b. Tyre fitting

- D Inflate inner tube and insert in tyre  
 E Lay tyre on rim and feed valve through hole in rim  
 F Work first bead over rim, using lever in final section  
 G Use similar technique for second bead. Finish at tyre valve position  
 H Push valve and tube up into tyre when fitting final section, to avoid trapping

commencing with the area furthest from the valve, ease the other bead of the tyre over the edge of the rim. Finish with the area close to the valve, pushing the valve up into the tyre until the locking cap touches the rim. This will ensure the inner tube is not trapped when the last section of the bead is edged over the rim with a tyre lever.

13 Check that the inner tube is not trapped at any point. Re-inflate the inner tube, and check that the tyre is seating correctly around the wheel rim. There should be a thin rib moulded around the wall of the tyre on both sides, which should be equidistant from the wheel rim at all points. If the tyre is unevenly located on the rim, try bouncing the wheel when the tyre is at the recommended pressure. It is probable that one of the beads has not pulled clear of the centre well.

14 Always run the tyres at the recommended pressures and never under or over inflate. The correct pressures for solo use are given in the Specifications Section of this Chapter. If a pillion passenger is carried, increase the rear tyre pressure only by

approximately 4 psi.

15 Tyre replacement is aided by dusting the side walls, particularly in the vicinity of the beads, with a liberal coating of French chalk. Washing up liquid can also be used to good effect, but this has the disadvantage of causing the inner surfaces of the wheel rim to rust.

16 Never replace the inner tube and tyre without the rim tape in position. If this precaution is overlooked there is good chance of the ends of the spoke nipples chafing the inner tube and causing a crop of punctures.

17 Never fit a tyre that has a damaged tread or side walls. Apart from the legal aspects, there is a very great risk of a blow-out, which can have serious consequences on any two-wheel vehicle.

18 Tyre valves rarely give trouble, but it is always advisable to check whether the valve itself is leaking before removing the tyre. Do not forget to fit the dust cap which forms an effective second seal.

#### 19 Fault diagnosis - wheels, brakes and tyres

| Symptom                                    | Reason/s   | Remedy   |
|--|--|--|
| Handlebars oscillate at low speeds         | Buckle or flat in wheel rim, most probably front wheel<br>Tyre not straight on rim | Check rim alignment by spinning wheel. Correct by retensioning spokes or having wheel rebuilt on new rim.<br>Check tyre alignment. |
| Machine lacks power and accelerates poorly | Brakes binding   | Warm brake drums provide best evidence. Readjust brakes.   |
| Brakes grab when applied gently            | Ends of brake shoes not chamfered<br>Elliptical brake drum                         | Chamfer with file.<br>Lightly skim in lathe (specialist attention needed).   |
| Brake pull-off sluggish                    | Brake cam binding in housing<br>Weak brake shoe springs                            | Free and grease.<br>Replace, if brake springs not displaced.   |
| Harsh transmission                         | Worn or badly adjusted chains<br>Hooked or badly worn sprockets                    | Adjust or replace as necessary.<br>Replace as a pair, together with chain.   |

# Chapter 6 Electrical system

## Contents

|  |   |  |    |
|--|---|--|----|
| General description                                  | 1 | Flasher bulbs - replacement            | 9  |
| Flywheel generator - checking output                 | 2 | Horn - location and adjustment         | 10 |
| Battery - examination and maintenance                | 3 | Wiring - layout and inspection         | 11 |
| Battery - charging procedure                         | 4 | Ignition and lighting switch           | 12 |
| Silicon rectifier - general description              | 5 | Fuse location and replacement          | 13 |
| Headlamp - replacing bulbs and adjusting beam height | 6 | Stop lamp switch - adjustment          | 14 |
| Tail and stop lamp - replacing bulbs                 | 7 | Fault diagnosis - electrical equipment | 15 |
| Speedometer bulb - replacement                       | 8 |  |    |

## Specifications

|                            |               |                                   |
|----------------------------|---------------|-----------------------------------|
| <b>Flywheel generator:</b> |               | Mitsubishi                        |
| Make                       |               | FAZ 10L or FH - L40               |
| Type                       |               | 8.7 volts (4 amp AC)              |
| Output lighting winding    |               | Asaki YN5 type                    |
| Neutral switch             |               | Asaki                             |
| Main switch                |               | Asaki YS10                        |
| Stop lamp switch           |               |                                   |
| <b>Battery:</b>            |               | YUASA BST 2 - 6                   |
| <b>Silicon rectifier</b>   |               | Feyi COZ - H 1/1<br>YUASA SZ - 3A |
| <b>Horn:</b>               |               | Imasen SM3 - 6V                   |
| <b>Flasher relay</b>       |               | Showa 8 - 9                       |
| <b>Fuse rating:</b>        |               | 10 amp                            |
| Headlight (Koito)          |               | 6 volts 15/15 watt                |
| Tail light (Imasen)        |               | 6 volts 3/10 watt                 |
| Speedometer (Nippon Seiki) | Neutral light | 6 volts 3 watt                    |
|                            | Meter light   | 6 volts 1.5 watt                  |

### 1 General description

The flywheel generator fitted to the Yamaha produces an alternating current and has a centre tapping on the generator coil as a means of varying the charge rate. When the engine is running without the lights, only half the generator coil is used to produce power, which is rectified before being fed into the battery. The battery then supplies the power for all the ancillary equipment, ie the horn, neutral light, stop light and flashers.

When the main lights are switched on the full generator coil is used and alternating current is fed directly to the lights with a switched connection to the rectifier. This latter arrangement keeps power supplied to the battery and avoids blowing the tail and speedometer bulbs if the headlamp bulb fails when

changing from full to dipped headlamp.

### 2 Flywheel generator - checking output

As explained in Chapter 3, the output can be checked only with specialised test equipment of the multi-meter type. If the generator is suspect, it should be checked by either a Yamaha agent or an auto-electrical expert.

### 3 Battery - examination and maintenance

1 Maintenance is normally limited to keeping the electrolyte

level just above the plates and separators. Modern batteries have translucent plastics cases, which make the check of electrolyte level much easier.

2 Unless acid is spilt, which may occur if the machine falls over, the electrolyte should always be topped up with distilled water until the correct level is restored. If acid is spilt on any part of the machine, it should be neutralised with an alkali such as washing soda and washed away with plenty of water, otherwise serious corrosion will occur. Top up with sulphuric acid of the correct specific gravity (1.260 to 1.280) ONLY when spillage has occurred.

3 It is seldom practicable to repair a cracked battery case because the acid already in the joint will prevent the formation of an effective seal. It is always best to replace a cracked battery, especially in view of the corrosion that will be caused by the leakage of acid.

#### 4 Battery - charging procedure

1 Whilst the machine is running, it is unlikely that the battery will require attention other than routine maintenance because the generator will keep it charged. However, if the machine is used for a succession of short journeys only, it is possible that the output from the generator will not be able to keep pace with the heavy electrical demand. Under these circumstances it will be necessary to remove the battery from time to time to have it charged independently.

2 The normal charging rate is 1 amp. A more rapid charge can be given in an emergency, but this should be avoided if possible because it will shorten the working life of the battery.

3 When the battery has been removed from a machine that has been laid up, a 'refresher' charge should be given every six weeks if the battery is to be maintained in good condition.

#### 5 Silicon rectifier - general description

1 The function of the silicon rectifier is to convert the AC produced by the generator to DC so that it can be used to charge the battery and operate the lighting circuit etc. The usual symptom of a defective rectifier is a battery which discharges rapidly because it is receiving no charge from the generator.

2 The rectifier is located where it is not exposed to water or battery acid, which will cause it to malfunction. The question of access is of relatively little importance because the rectifier is unlikely to give trouble during normal operating conditions. It is not practicable to repair a damaged rectifier; replacement is the only satisfactory solution. One of the most frequent causes of rectifier failure is the inadvertent connection of the battery in reverse which results in a reverse current flow.

3 Damage to the rectifier is also liable to occur if the machine is run without a battery for any period of time. A high voltage will develop in the absence of any load on the coil which will cause a reverse flow of current and consequent damage to the rectifier cells.

4 It is not possible to check whether the rectifier is functioning correctly without the appropriate test equipment. A Yamaha agent or an auto-electrical expert are best qualified to advise in such cases.

5 Do not loosen the rectifier locking nut or bend, cut, scratch or rotate the wafers. Any such action will cause the electrode alloy coating to peel and destroy the working action.

#### 6 Headlamp - replacing bulbs and adjusting beam height

1 To remove the headlamp rim, unscrew the screw at the base of the rim. The rim will then pull off, complete with the reflector unit and bulbs.

2 The reflector unit contains a double-filament bulb which provides the main and dipped headlamp beams. It is controlled from a dipswitch mounted on the handlebars.

3 It is not necessary to refocus the headlamp when a new bulb is fitted because the bulbs are of the pefocus type. To release the bulb holder from the reflector, twist and pull.

4 Beam height is adjusted by slackening the two headlamp shell retaining nuts and tilting the headlamp either upward or downward. Adjustments should always be made with the rider normally seated.

5 UK lighting regulations stipulate that the lighting system must be arranged so that the light will not dazzle a person standing in the same horizontal plane as the vehicle at a distance greater than 25 yards from the lamp, whose eye level is not less than 3 feet 6 inches above that plane. It is easy to approximate this setting by placing the machine 25 yards away from a wall, on a level road, and setting the beam height so that it is concentrated at the same height as the distance from the centre of the headlamp to the ground. The rider must be seated normally during this operation and also the pillion passenger, if one is carried regularly.

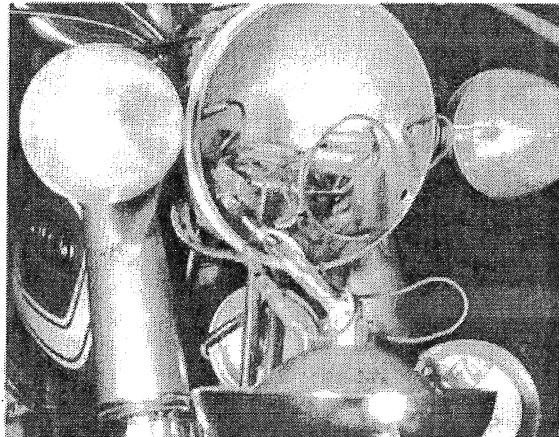

6.2 Reflector unit contains a double filament bulb and no parking light

#### 7 Tail lamp - replacing bulb

1 The moulded plastics cover of the rear lamp is retained by two screws. When these screws are removed, the cover can be removed and the bulb exposed.

2 To release the bulb from its holder, press it inwards, turn to the left and pull out. Press in the new bulb, turn to the right and pull downwards so that the stops locate. Refit the cover, making sure that the rubber moulding which surrounds the cover is located correctly to exclude water.

3 Make sure that the flexible contact makes a good connection with the bottom contact of the bulb, otherwise the bulb may work only intermittently and eventually 'blow'.

4 The tail lamp has a 3 watt rating, and the stop lamp a 10 watt rating.

#### 8 Speedometer bulbs - replacement

1 The speedometer bulb and the ignition warning light bulb holders push into the speedometer head.

2 After the holder is pulled clear the bulbs can be replaced in the same manner as the tail light bulb. The holders are then pushed back into the speedometer head.

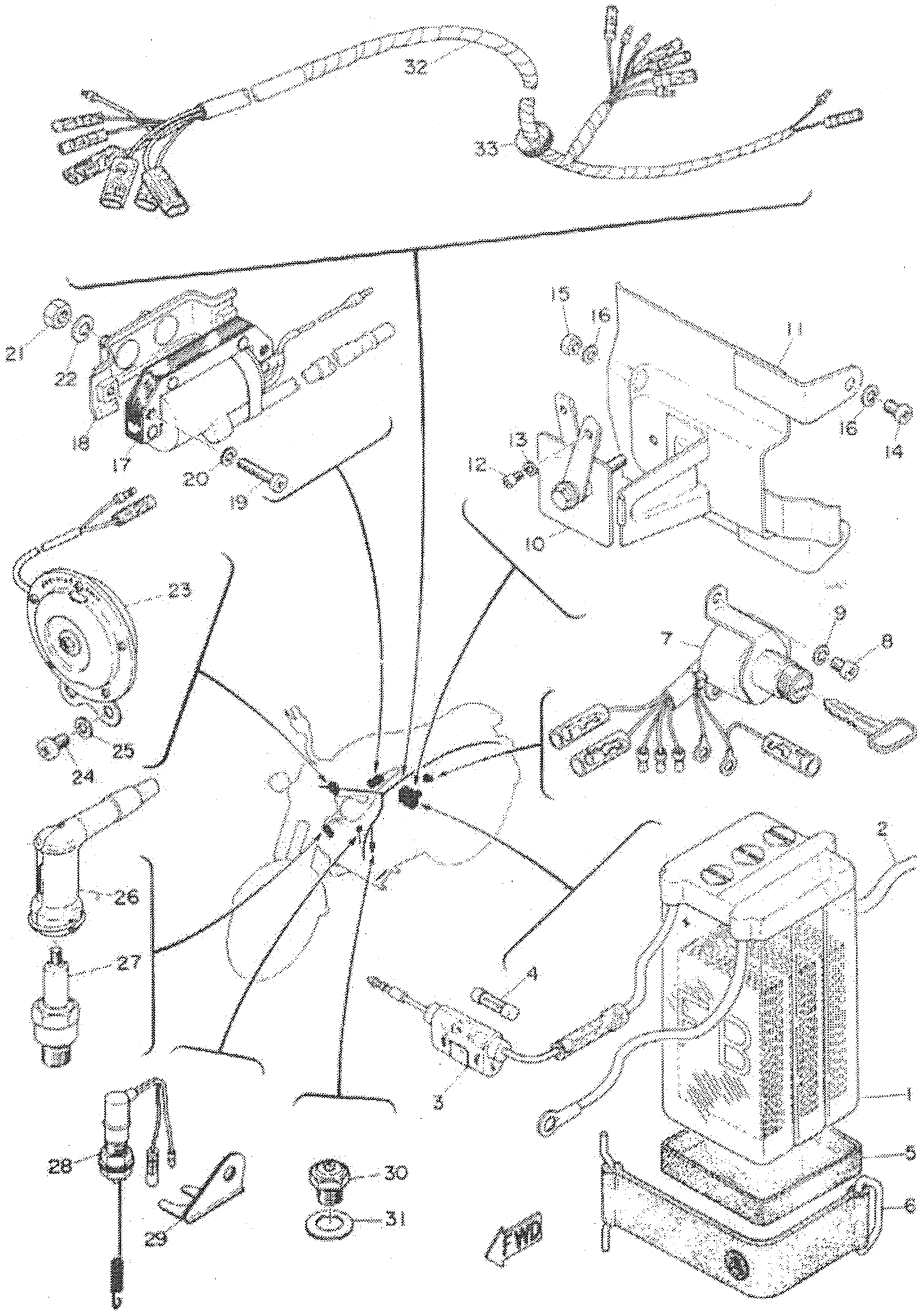

Fig. 6.1. Electrical components

- |   |                             |                                    |                              |
|---|-----------------------------|------------------------------------|------------------------------|
| 1 Battery                               | switch                      | 17 Ignition coil                   | 25 Spring washer - 2 off     |
| 2 Vent pipe                             | 9 Spring washer             | 18 Coil holder                     | 26 Plug suppressor cap       |
| 3 Fuse holder                           | 10 Rectifier                | 19 Coil holder screw - 2 off       | 27 Spark plug                |
| 4 Fuse                                  | 11 Rectifier mounting plate | 20 Spring washer - 2 off           | 28 Stop lamp switch          |
| 5 Battery strap                         | 12 Panhead screw - 2 off    | 21 Nut - 2 off                     | 29 Stay for stop lamp switch |
| 6 Battery carrier                       | 13 Spring washer - 2 off    | 22 Spring washer - 2 off           | 30 Neutral switch            |
| 7 Combined ignition and lighting switch | 14 Panhead screw - 2 off    | 23 Horn                            | 31 Gasket for neutral switch |
| 8 Panhead screw for retaining           | 15 Nut                      | 24 Screw for horn mounting - 2 off | 32 Wiring harness            |
|   | 16 Spring washer - 3 off    |                                    | 33 Cable grommet             |

### 9 Flasher bulbs - replacement

- 1 The moulded plastics cover of the flasher lamp is retained by two screws. When these screws are removed, the cover can be removed and the bulb exposed.
- 2 To release the bulb from its holder, press it inwards, turn to the left and pull out. Press in the new bulb, turn to the right and pull downwards so that the stops locate. Refit the cover making sure the rubber moulding that surrounds the cover is located correctly to exclude water.

### 10 Horn - location and adjustment

- 1 The horn is mounted on a bracket attached to the bottom yoke of the forks, immediately behind the front number plate.
- 2 There is no means of adjusting the horn note.

### 11 Wiring - layout and inspection

- 1 The wiring harness is colour-coded and will correspond with the accompanying wiring diagrams.
- 2 Visual inspection will show whether any breaks or frayed outer coverings are giving rise to short circuits. Another source of trouble may be the snap connectors, particularly where the connector has not been pushed home fully in the outer casing.
- 3 Intermittent short circuits can often be traced to a chafed wire which passes through or close to a metal component, such as a frame member. Avoid tight bends in the wire or situations where the wire can become trapped or stretched between casings.

### 12 Ignition and lighting switch

- 1 The same key operated switch is used for ignition and lighting. This switch is not repairable and if found faulty must be replaced.
- 2 New keys are not available so if both keys are lost a new switch must be fitted.
- 3 On no account oil the switch or the oil will spread across the internal contacts and form an effective insulator.

### 13 Fuse - location and replacement

- 1 A fuse within a moulded plastics case is incorporated in the electrical system to give protection from a sudden overload, such as may occur during a short circuit. It is found in close proximity to the battery, retained in metal clips. The fuse is rated at 10 amps; a plastic bag containing a spare fuse of similar rating is normally carried in a plastic bag attached to the wiring harness.
- 2 If a fuse blows, it should not be replaced until a check has shown whether a short circuit has occurred. This will involve checking the electrical circuit to identify and correct the fault. If this precaution is not observed, the replacement fuse, which may be the only spare, may blow immediately on connection.
- 3 When a fuse blows whilst the machine is running and no spare is available a get you home remedy is to remove the blown fuse and wrap it in silver paper before replacing it in the fuse holder. The silver paper will restore electrical continuity by bridging the broken wire within the fuse. This expedient should never be used if there is evidence of a short circuit or other major electrical fault, otherwise more serious damage will be caused. Replace the 'doctored' fuse at the earliest possible opportunity to restore full circuit protection.

### 14 Stop lamp switch - adjustment

- 1 All models have a stop lamp switch fitted to operate in



9.2a Make sure lens seating gasket is in good order when replacing bulbs

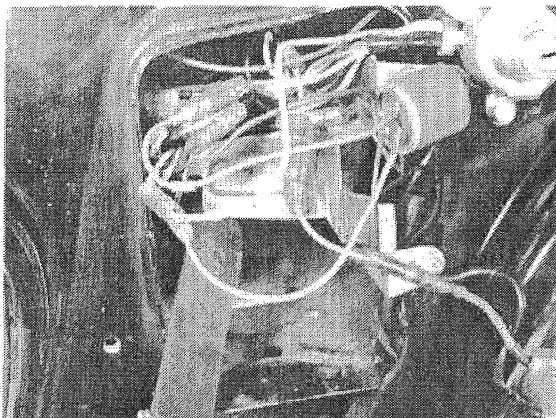

9.2b Flasher unit is located close to ignition/lighting switch

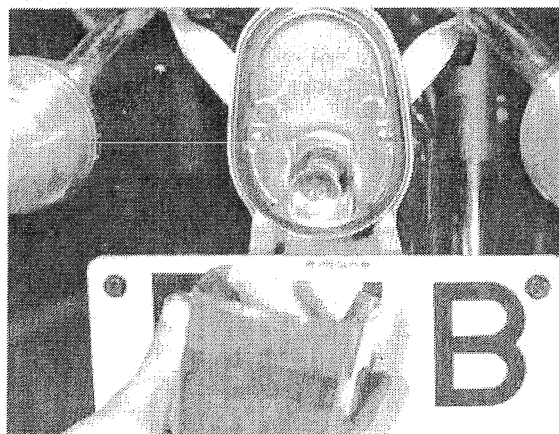

7.4 Tail/stop lamp has twin filament bulb, with offset pins

conjunction with the rear brake pedal. The switch is located immediately to the rear of the crankcase, on the right hand side of the machine. It has a threaded body, permitting a range of adjustment.

2 If the stop lamp is late in operating, slacken the locknuts and turn the body of the lamp in an anticlockwise direction so that the switch rises from the bracket to which it is attached. When

this adjustment seems near correct, tighten the locknuts and test.  
3 If the lamp operates too early, the locknuts should be slackened and the switch body turned clockwise so that it is lowered in relation to the mounting bracket.

4 As a guide, the light should operate after the brake pedal has been depressed by about 2 cm (¾ inch).

15 Fault diagnosis - electrical equipment

| Symptom                      | Reason/s                         | Remedy  |
|------------------------------|----------------------------------|---|
| Complete electrical failure  | Blown fuse                       | Check wiring and electrical components for short circuit before fitting new 10 amp fuse. Check battery connections, also whether connections show signs of corrosion. |
|                              | Isolated battery                 |   |
| Dim lights, horn inoperative | Discharged battery               | Recharge battery with battery charger and check whether alternator is giving correct output.  |
| Constantly 'blowing' bulbs   | Vibration, poor earth connection | Check whether bulb holders are secured correctly. Check earth return or connections to frame.   |

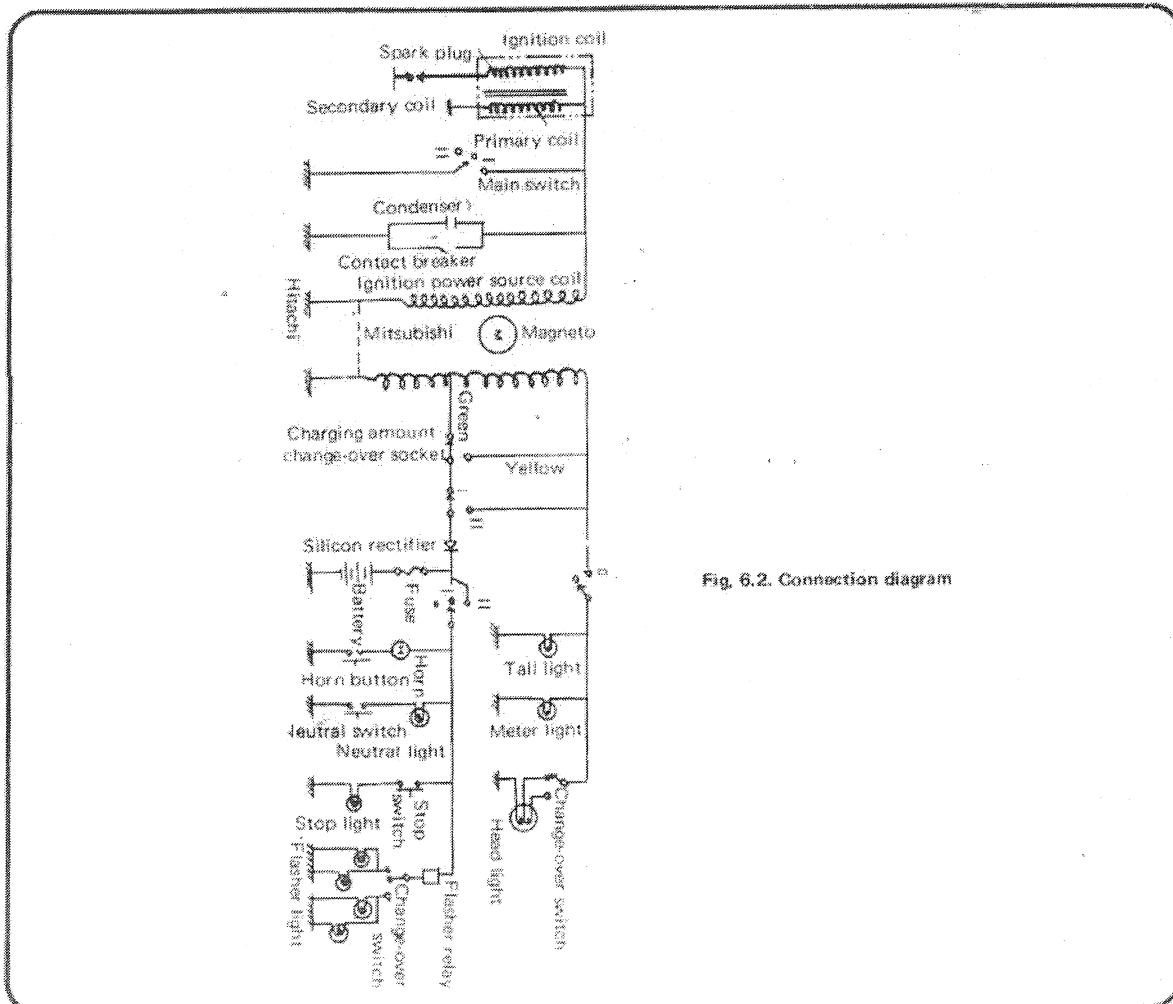

Fig. 6.2. Connection diagram

Note: If you often drive at slow speed or use the stop light and flasher light frequently, the battery will discharge, the following slight change in the circuit will allow better charging.

Connect the green wire of the main switch to the terminal of the yellow as illustrated in the circuit diagram with a dotted line.

| Color Position | Black-earth | Green-white | Yellow-white | Yellow-blue | Red-brown |
|----------------|-------------|-------------|--------------|-------------|-----------|
| 0              | o           | x           | x            | x           | x         |
| 1              | x           | o           | x            | x           | o         |
| 11             | x           | x           | o            | o           | o         |

- 1 Horn switch
- 2 Sub switch
- 3 Main switch
- 4 Speedometer
- 7 Flasher relay
- 8 Rear flasher light
- 9 Ignition coil
- 10 Spark plug
- 11 Neutral switch
- 12 Stop switch
- 13 Silicon rectifier
- 14 Fly wheel magneto
- 15 Meter light 6V 1.5W
- 16 Neutral pilot light 6V 3W
- 17 Head light 6V 15W D
- 18 Tail lamp 6V 3W
- 19 Fuse 10A
- 20 Battery 6V 4AH

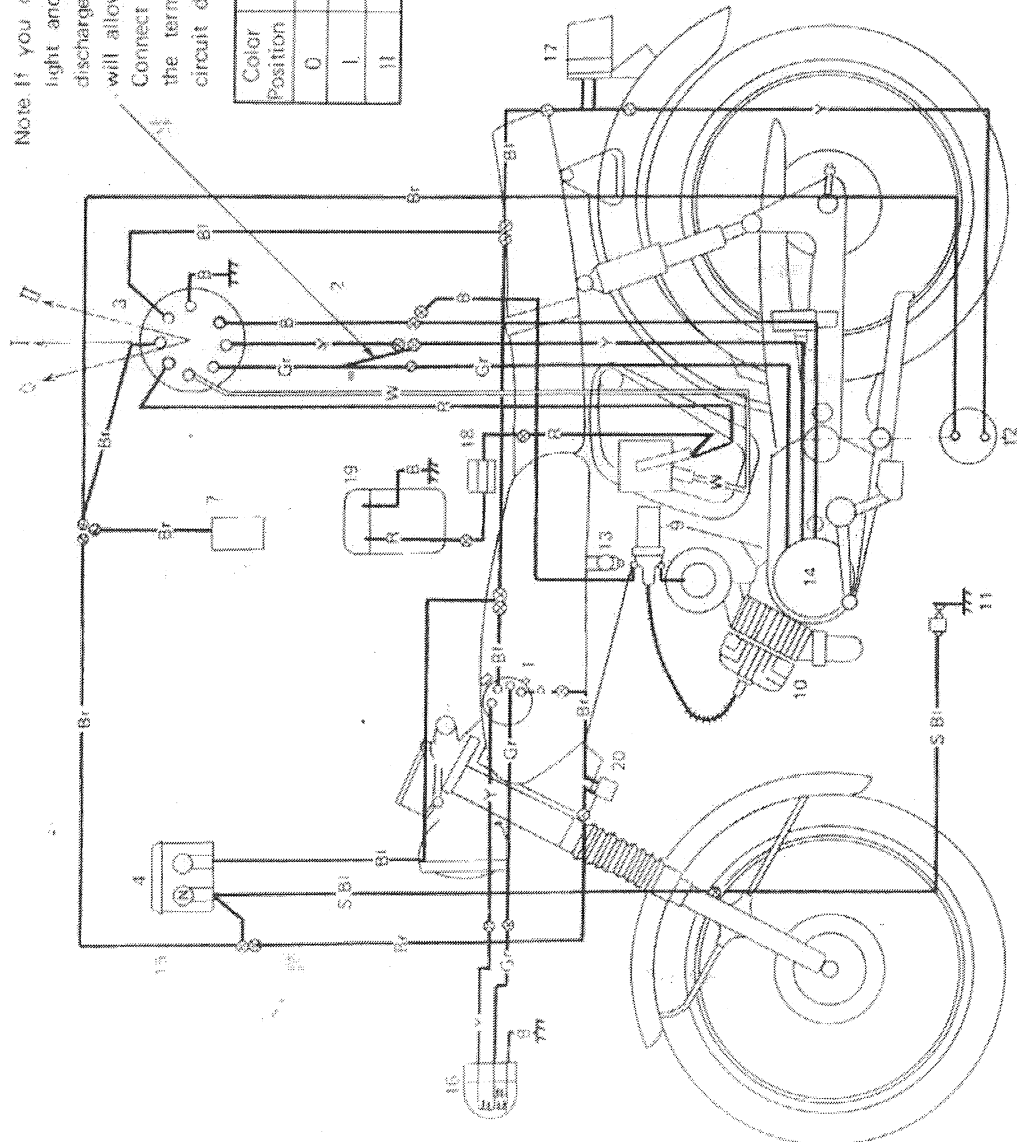

Fig. 6.3. FST-E Wiring diagram



# Chapter 7 The FSIE-DX model

## Contents

|   |   |
|---|---|
| General description ... ..  | 1 |
| Front forks ... ..  | 2 |
| Front disc brake - general description ... ..                                 | 3 |
| Front disc brake - removing and replacing the disc and pads ... ..            | 4 |
| Front disc brake - removing, renovating and replacing the caliper unit ... .. | 5 |

|   |   |
|---|---|
| Master cylinder - examination and renewing seals ... .. | 6 |
| Hydraulic brake hose and pipe - examination ... ..      | 7 |
| Bleeding the hydraulic system ... ..                    | 8 |
| Other changes in specification ... ..                   | 9 |

### 1 General description

1 During March 1975, a restyled version of the original FS1-E model became available in the UK, the most noticeable difference in specification being the fitting of an hydraulically-operated disc brake to the front wheel. The lower fork legs were redesigned and strengthened to provide a more robust assembly that would withstand the increased braking stresses and to accommodate the mounting points for the disc brake caliper. Because the drum brake used previously had been dispensed with, it was necessary to find an alternative take-off point for the speedometer drive gearbox. It was relocated on the extreme left-hand side of the front wheel hub, to which the drive arrangement was transferred.

2 Other changes in specification dispensed with the handlebar-operated choke control and substituted one of the push-pull type in the top of the carburettor housing. All the electrical switchgear was regrouped in a single casing around the left-hand handlebar grip and the ignition/lighting switch was moved to a new position, adjacent to the speedometer, where it was more accessible. Flashing indicator lamps became part of the standard specification of every machine, as did the single, rear-view mirror. Slightly flatter handle bars, with a cross-brace, provided an improved riding position and to complete the overall effect, a new colour scheme and styling helped enhance the general appearance of the machine.

3 For the 1976 season, an additional feature was incorporated in all the FSIE-DX models - two bolt-on frame tubes that form front down tubes and convert the spine-type frame into one of the semi-cradle type. Mounting points for the twin tubes are

formed by attaching a small bracket to the main frame assembly, immediately to the rear underside of the steering head, and by using the two cast-in lugs that form an integral part of the crankcase castings. Further changes in colour schemes and styling were made at the same time, including the use of a petrol tank transfer in place of the name panel attached by two cross-head screws.

### 2 Front forks

1 As mentioned previously, the front fork assembly has been stiffened up in order to withstand the increased stresses that can be expected from a disc-type front brake. It was also necessary to redesign the right-hand lower fork leg so that a mounting point was provided for the bracket that retains the front brake caliper unit.

2 Although internally the forks are very similar in design to those described in Chapter 4 of this manual, several minor modifications have been made. The spring seating has been dispensed with and a different form of spring guide used, which is much shallower. The oil seal is now preceded by a snap ring and washer. The only other difference is an oil restrictor cum bump stop, retained in the bottom of each lower fork leg. The dismantling and reassembly procedure is virtually unaltered.

3 Both fork legs of the strengthened fork assembly each have a capacity of 134 ccs of 10W/30 oil.

### 3 Front disc brake - general description

1 To keep abreast of current developments and to provide

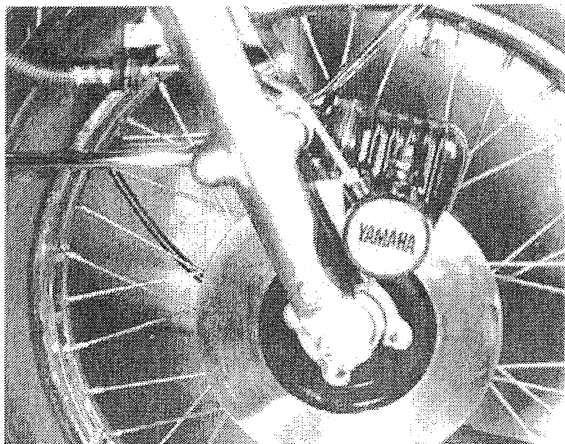

1.1 The disc brake and strengthened lower fork leg

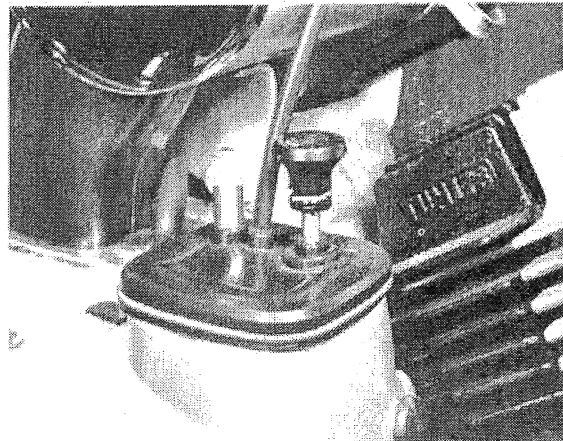

1.2a The manually operated choke control

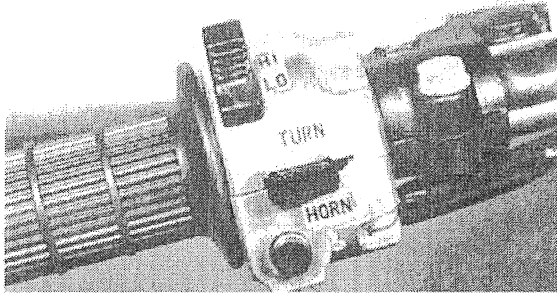

1.2b All the electrical switchgear is grouped on left-hand side of handlebars

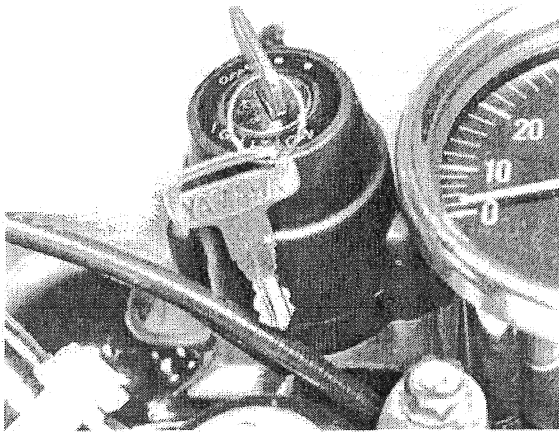

1.2c Ignition/lighting switch is adjacent to speedometer.

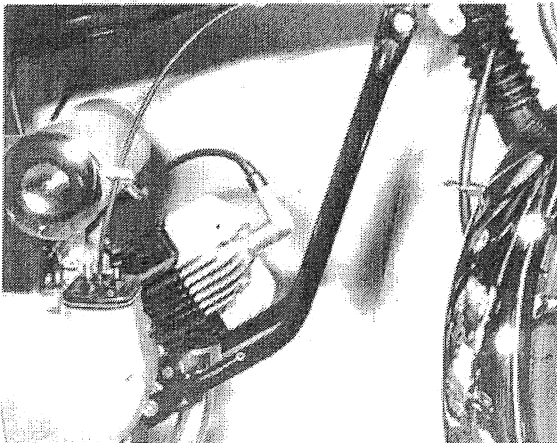

1.3 Twin down tubes interconnect the steering head with the crankcase

increased braking efficiency, the FS1E-DX models are fitted with an hydraulic-operated front disc brake of the fixed caliper type. The right-hand side of the handlebars carries the master cylinder, which forms an integral part of the front brake lever. The caliper unit is attached to the right-hand fork leg and the disc to the right-hand side of the front wheel hub. The master cylinder is connected to the caliper by a brake hose and pipe, which contains the hydraulic fluid necessary to transmit the braking action from the handlebar lever to the brake caliper.

2 When the front brake lever is depressed, it causes the master piston to move within the master cylinder, to which it is linked. As the piston moves in the cylinder, it traps the brake fluid, causing a pressure build-up which is transmitted to the caliper unit via the brake hose and pipe that forms the connecting link. The pressure in the caliper cylinders causes the brake pads to move in their respective housings and bear against the disc, the friction between the two pads and the disc providing the braking action. As the brake lever is released, the pressure falls and the pistons return to their original positions through the action of return springs. The pads no longer bear on the disc and the wheel is again free to revolve.

3 The leverage of the brake lever is such that it produces a force at the master cylinder piston approximately four times that applied to the brake lever itself. This is one of the reasons why a hydraulic braking system is more efficient than the older and more conventional drum brake type.

#### 4 Front disc brake - removing and replacing the disc and pads

1 The brake disc, attached to the right-hand side of the front wheel hub by four bolts, rarely requires attention. Check for run out, which may have occurred as the result of crash damage, and for wear. Run out should not exceed 0.15 mm at any point and the disc itself must not be permitted to wear below the limit thickness of 6.5 mm. If these figures are exceeded in either case, the disc must be renewed.

2 The disc bolts to a disc bracket, which itself bolts to the right-hand side of the wheel hub. It is necessary to detach the front wheel from the machine by first placing the machine on the centre stand so that the front wheel is raised clear of the ground. Slacken the clamp bolt at the base of the lower, left-hand fork leg and withdraw the split pin from the front wheel spindle nut, in this case on the right-hand side of the machine. Disconnect the speedometer drive cable. Slacken and remove the spindle nut, then withdraw the spindle; the wheel can now be withdrawn from the forks. It is preferable to insert a wooden

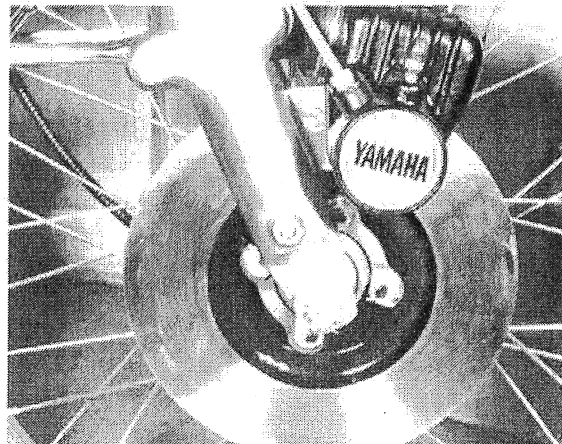

3.1 Disc brake is hydraulically operated

wedge between the brake pads at this stage, to prevent them from being expelled if the brake lever is inadvertently operated. Remove the four bolts from the inner edge of the brake disc and remove the disc. Note that each bolt is fitted with a lock washer, which must not be omitted during reassembly.

3 To remove the brake pads, first unscrew the cross-head screw that retains the outer pad, then withdraw the pad and its support, followed by the inner pad. Provided care is used, they can be prised out of position with a screwdriver.

4 The pads are moulded from a special resin impregnated asbestos compound and if renewal is necessary, only the correct replacement should be fitted. Each pad has a red line painted around the periphery, which represents the wear limit. On no account should the pad be allowed to wear beyond. It is preferable to remove the front wheel before the pads can be removed although the caliper mounting bolts can be slackened so that the unit can be swung clear of the disc as an alternative. Do not apply the brake in an attempt to displace the pads. If the actuating piston moves beyond its normal limit of travel, air will be admitted to the hydraulic system, necessitating a complete bleeding of the system when reassembly is completed.

5 Reassembly is accomplished by reversing the procedure used for dismantling. Make sure that the brake pads are correctly located in the caliper that the projection from the left-hand side of the hub engage with the speedometer drive gearbox recesses and that the front wheel revolves quite freely when reassembly is complete. Always check the brake action before taking the machine on the road.

#### 5 Front disc brake - removing, renovation and replacing the caliper unit

1 Before the caliper assembly can be removed from the right-hand fork leg, it is first necessary to drain off the hydraulic fluid. Disconnect the brake pipe at the union connection it makes with the caliper unit and allow the fluid to drain into a clean container. It is preferable to keep the front brake lever applied throughout this operation, to prevent the fluid from leaking out of the reservoir. A thick rubber band cut from a section of inner tube will suffice, if it is wrapped tightly around the lever and the handlebars. Cover the end of the pipe with a polythene bag, after the fluid has drained, to keep it clean.

2 Note that brake fluid is an extremely efficient paint stripper. Take care to keep it away from any paintwork on the machine or from any clear plastic, such as that sometimes used for instrument glasses.

3 When the fluid has drained off, remove the caliper mounting bolts and nuts, then rotate the caliper unit upwards and lift it away from the disc and the machine. The brake pads can now be removed, using the procedure described in the preceding Section (paragraph 3).

4 Unscrew the two caliper retaining bolts and remove the caliper unit from the fork leg to which it is attached.

5 Remove the ring that retains the rubber boot, the boot itself and the two blind plugs in the side of the unit, which can be prised out with a screwdriver. Remove the small circlips, then withdraw the two pins that retain the inner end of the caliper support bracket. They are threaded internally and can be withdrawn with a pair of pliers if a 5 mm screw is inserted into the threaded portion. Remove the support bracket and the anti-rattle spring.

6 To displace the piston, apply a blast of compressed air through the brake fluid inlet. Take care to catch the piston as it emerges from its bore - if dropped or prised out of position with a screwdriver, it may be damaged irreparably and will have to be replaced. Remove the piston seal and dust seal from the caliper body.

7 The parts removed should be cleaned thoroughly, using only brake fluid as the liquid. Petrol, oil or paraffin will cause the various seals to swell and degrade, and should not be used under

any circumstances. When the various parts have been cleaned, they should be stored in polythene bags until reassembly, so that they are kept dust free.

8 Examine the piston for score marks or other imperfections. If they have any imperfections they must be renewed, otherwise air or hydraulic fluid leakage will occur, which will impair braking efficiency. With regard to the various seals, it is advisable to renew them all, irrespective of their appearance. It is a small price to pay against the risk of a sudden and complete front brake failure. It is standard Yamaha practice to renew the seals every two years, even if no braking problems have occurred.

9 Reassemble under clinically-clean conditions, by reversing the dismantling procedure. Renew the caliper unit bolts as a safety precaution, even if they appear undamaged. Reconnect the hydraulic fluid pipe and make sure the union has been tightened fully. Before the brake can be used, the whole system must be bled of air, by following the procedure described in Section 7 of this Chapter.

#### 6 Master cylinder - examination and renewing seals

1 The master cylinder and hydraulic fluid reservoir take the form of a combined unit mounted on the right-hand side of the handlebars, to which the front brake lever is attached.

2 Before the master cylinder unit can be removed and dismantled, the system must be drained. Place a clean container below the brake caliper unit and attach a plastic tube from the bleed screw of the caliper unit to the container. Open the bleed screw one complete turn and drain the system by operating the brake lever until the master cylinder reservoir is empty. Close the bleed screw and remove the tube.

3 Before dismantling the master cylinder, it is essential that a clean working area is available on which the various components parts can be laid out. Use a sheet of white paper, so that none of the smaller parts can be overlooked.

4 Disconnect the stop lamp switch and front brake lever, taking care not to misplace the brake lever return spring. The stop lamp switch is attached to the bolt that acts as the brake lever pivot. Remove the split pin and castellated nut and take off the switch. Remove the brake hose by unscrewing the banjo union bolt. Take the master cylinder away from the handlebars. Check that all fluid has drained from the reservoir, by taking off the reservoir cap and the diaphragm below.

5 Withdraw the rubber boot that protects the end of the master cylinder and remove the snap ring that holds the piston assembly

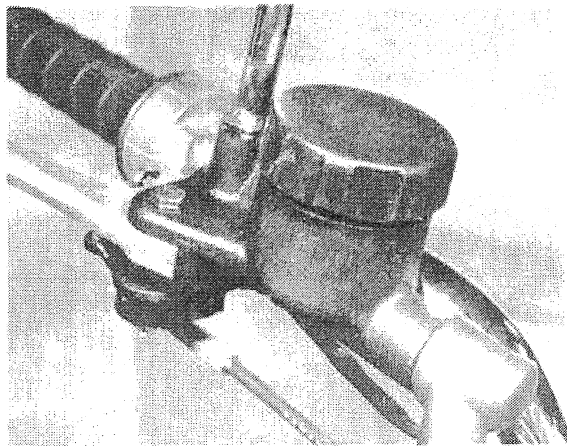

6.1 Master cylinder and hydraulic fluid reservoir on right-hand side of handlebars

in position, using a pair of circlip pliers. The piston assembly can now be drawn out, and the spring below it.

6 To dismantle the piston assembly, remove the 'E' clip at the far end and then the cylinder cup retainer. The cylinder cup can then be detached.

7 Examine the piston and the cylinder cup very carefully. If either is scratched or has the working surface impaired in any other way, it must be renewed without question. Reject the various seals, irrespective of their condition, and fit new ones in their place. It often helps to soften them a little before they are fitted by immersing them in a container of clean brake fluid.

8 When reassembling, follow the dismantling procedure in reverse, but take great care that none of the component parts is scratched or damaged in any way. Use brake fluid as the lubricant whilst reassembling. When assembly is complete, reconnect the brake fluid pipe and tighten the banjo union bolt to the recommended setting. Add about 30 cc of brake fluid to the reservoir and bleed the system of air by following the procedure described in Section 8 of this Chapter.

### 7 Hydraulic brake hose and pipe - examination

1 An external brake hose and pipe is used to transmit the hydraulic pressure to the caliper unit when the front brake is applied. The brake hose is of the flexible type, fitted with an armoured surround. It is capable of withstanding pressures up to 350 kg/cm<sup>2</sup>. The brake pipe attached to it is made from double steel tubing, zinc plated to give better corrosion resistance.

2 When the brake assembly is being overhauled, check the condition of both the hose and the pipe for signs of leakage or scuffing, if either had made rubbing contact with the machine whilst it is in motion. The union connections at either end must also be in good condition, with no stripped threads or damaged sealing washers.

### 8 Bleeding the hydraulic system

1 As mentioned earlier, brake action is unpaired or even rendered inoperative if air is introduced into the hydraulic system. This can occur if the seals leak, the reservoir is allowed to run dry or if the system is drained prior to the dismantling of any component part of the system. Even when the system is refilled with hydraulic fluid air pockets will remain and because air will compress, the hydraulic action is lost.

2 Check the fluid content of the reservoir and fill almost to the top. Remember that hydraulic brake fluid is an excellent paint stripper, so beware of spillage, especially near the petrol tank.

3 Place a clean glass jar below the brake caliper unit and attach a clear plastic tube from the caliper bleed screw to the container. Place some clean hydraulic fluid in the container so that the pipe is always immersed below the surface of the fluid.

4 Unscrew the bleed screw one complete turn and pump the handlebar lever slowly. As the fluid is ejected from the bleed screw the lever in the reservoir will fall. Take care that the level does not drop too low whilst the operation continues, otherwise air will re-enter the system, necessitating a fresh start.

5 Continue the pumping action with the lever until no further air bubbles emerge from the end of the plastic pipe. Hold the brake lever against the handlebars and tighten the caliper bleed screw. Remove the plastic tube after the bleed screw is closed.

6 Check the brake action for sponginess, which usually denotes there is still air in the system. If the action is spongy, continue the bleeding operation in the same manner, until all traces of air are removed.

7 Bring the reservoir up to the correct level of fluid (within ½ inch of the top of the reservoir) and replace the diaphragm seal and cap. Check the entire system for leaks. Recheck the brake action.

8 Note that fluid from the container placed below the brake caliper unit whilst the system is bled, should not be re-used.

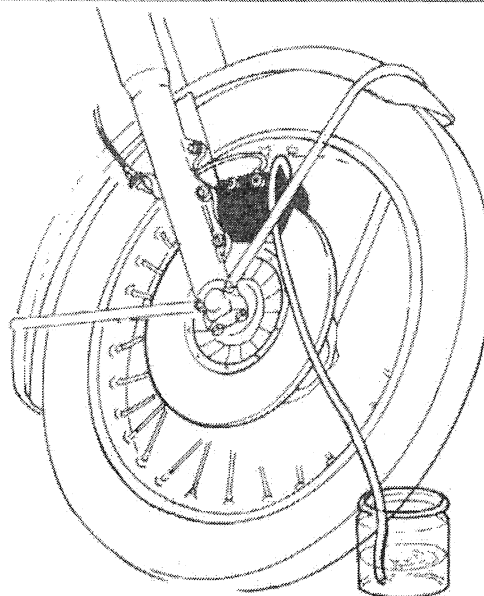

Fig. 7.1 Bleeding the front disc brake

### 9 Other changes in specification

1 All models having a front wheel disc brake are fitted with a 2.50 inch section tyre, in place of the 2.25 inch tyre used previously.

2 An NGK B-6HS spark plug is now fitted as standard to some models.

3 The carburettor settings remain unaltered, apart from the substitution of an E4 needle jet in place of the original.

4 Alternative batteries of either G.S. or F.B. manufacture are sometimes fitted. These have the type number 6N4A-4D.

5 The 6 volt double-filament headlamp bulb has now been upgraded to a wattage of 18/18. The tail/stop lamp bulb, also of the double filament type, has been upgraded to a wattage of 5.3/17.

6 The rear brake drum is fitted with a rubber inspection plug. When the plug is removed, the brake linings can be inspected to determine the amount of wear.

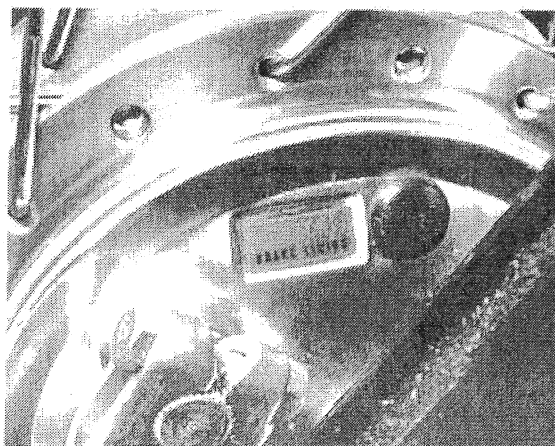

9.6 Inspection aperture for rear brake linings

# Index

- Air cleaner - 52
- A**
- Generator - 15, 38, 55, 82
- B**
- Barrel - 15, 29  
 Battery - 82  
 Bearings - engine - 29, 33  
 Bearings - wheels - 73  
 Bearings - steering head - 61  
 Bleeding hydraulic system - 91  
 Brakes - front wheel - 73  
           - rear wheel - 75  
 Brake pedal - 79
- C**
- Cable - speedometer - 71  
 Caliper unit, disc brake - 90  
 Carburettor - 48  
 Centre stand - 67  
 Clutch assembly - 33  
 Clutch plates - 33, 38  
 Condenser - 58  
 Contact breaker assembly - 58  
 Contact breaker adjustment - 55  
 Contact breaker cam - 56  
 Crankcases - 33, 34  
 Crankshaft - 29, 34  
 Cylinder head - 33
- D**
- Disc brake - 89, 90  
 Disc valve - 34  
 Dual seat - 71
- E**
- Exhaust system - 52
- F**
- Final drive chain - 79  
 Final drive sprocket - 38, 79  
 Flashing indicator lamps - 85  
 Flywheel generator - 15, 38, 55, 82  
 Frame - 67  
 Front wheel - 72  
 Front wheel assembly - 73  
 Front wheel bearings - 73  
 Front wheel forks - 73, 89  
 Fuse location - 85  
 Fault diagnosis - 63, 63, 69, 84, 99, 105
- G**
- Gearchange - 26  
 Gearbox components - 29, 34  
 Gearbox pinions - 34  
 Gearbox removal - 13  
 Gearbox - 15
- H**
- Headlamp - 83  
 Horn push - 85  
 Hydraulic hoses and pipes - 91
- I**
- Ignition coil - 55  
 Ignition switch - 85  
 Ignition timing - 69
- K**
- Kickstarter - 24, 34
- M**
- Master cylinder - 90
- O**
- Oil seals - 29
- P**
- Pedal assembly - 78  
 Pedalling gear chain - 79  
 Petrol feed pipe - 48  
 Petrol/oil mix - 47  
 Petrol tank - 47  
 Petrol tap - 47  
 Pistons - 33, 42  
 Primary drive - 34
- R**
- Rear suspension - 87  
 Rear wheel sprocket - 76  
 Rear wheel assembly - 78
- S**
- Silicon rectifier - 83  
 Spark plugs - 59  
 Specification changes, FS1E-DX model - 91  
 Speedometer - 67  
 Speedometer drive gears - 73  
 Steering head lock - 71  
 Steering head races - 61  
 Stop lamp - 85  
 Stop lamp switch - 85  
 Swinging arm fork - 67  
 Swinging rear arm suspension - 67
- T**
- Telescopic front forks - 61  
 Tyres - 79
- W**
- Wiring diagrams - 86, 87





